

User's Manual

LG Programmable Logic Controller

GLOFA

Fnet (FieldBus)

Mnet (Mini-Map)

LG Industrial Systems

Contents

Chapter 1 Introduction 1-1

Chapter 2 Terms and concepts of communication

2.1 Description of terms2-1
2.2 Concept of Fnet communication 2-4
 2.2.1 How to generate and move LAS 2-4
 2.2.2 How to assign token 2-4
2.3 Concept of Mnet communication 2-5
 2.3.1 How to generate and move token 2-5
 2.3.2 Token Passing 2-5

Chapter 3 General specifications

3.1 General specifications of communication module(Fnet, Mnet)3-1
3.2 Structure and configuration..... 3-2
 3.2.1 Fnet master module structure : G3L-FUEA, G3L-FUOA, G4L-FUEA, G6L-FUEA 3-2
 3.2.2 Fnet slave module structure : G3L-RBEA, G3L-RBOA, G4L-RBEA 3-4
 3.2.3 Fnet Computer interface module structure : G0L-FUEA..... 3-6
 3.2.4 Fnet LED signal name and indication content 3-7
 3.2.5 Fnet station number setting 3-7
 3.2.6 Fnet mode setting 3-8
 3.2.7 Mnet module structure : G3L-MUEA3-10
 3.2.8 Mnet Computer interface module structure : G0L-MUEA3-11

Chapter 4 Transmission specifications

4.1 Transmission specifications of Fnet4-1
 4.1.1 Transmission specifications of Fnet Master module 4-1
 4.1.2 Transmission specifications of Fnet Slave module 4-2
 4.1.3 Transmission specifications of Fnet Option module 4-2
4.2 Transmission specifications of Mnet4-4
4.3 Cable specifications4-5
 4.3.1 Twisted pair cable for Fnet 4-5
 4.3.2 Optical cable for Fnet 4-6
 4.3.3 Coaxial cable for Mnet 4-7

4.4	How to connect communication cable	4-8
4.4.1	Electric(twisted pair) cable connection	4-8
4.4.2	Electric(twisted pair) cable connector connection	4-8
4.4.3	Optical cable connection	4-9
4.5	Terminal resistance	4-9
4.5.1	Electric network terminal resistance of Fnet	4-9
4.5.2	Terminal resistance of Mnet	4-10

Chapter 5 System configuration

5.1	GLOFA PLC network system	5-1
5.2	Fnet network system	5-2
5.2.1	Configuration of Fnet master system (electric network)	5-2
5.2.2	Configuration of Fnet master system (optical network)	5-2
5.2.3	Configuration of Fnet master system (network combined with electric/optical module)	5-3
5.2.4	Configuration of Fnet slave system (electric network)	5-4
5.2.5	Configuration of Fnet slave system (optical network)	5-5
5.2.6	Configuration of Fnet slave system (electric/optical network)	5-6
5.2.7	Configuration of Fnet combined system (electric/optical network)	5-7
5.3	Mnet network system	5-9
5.3.1	System configuration of Mnet	5-9
5.3.2	System configuration of Mnet (including other company' s product- Ex. GOLDSEC-M series).....	5-9
5.4	Combined system of Fnet and Mnet	5-10

Chapter 6 Communication program

6.1	Programming method.....	6-1
6.2	<i>High speed link</i>	6-2
6.2.1	Introduction	6-2
6.2.2	Tx/Rx data processing of <i>high speed link</i>	6-3
6.2.3	Operation procedure by <i>high speed link</i>	6-4
6.2.4	Parameter setting of <i>high speed link</i>	6-5
6.2.5	Operation of <i>high speed link</i>	6-11
6.2.6	Relation between <i>high speed link</i> and CPU mode switch	6-13
6.2.7	Communication status information of <i>high speed link</i>	6-14
6.2.8	Speed calculation of <i>high speed link</i>	6-19
6.2.9	Ex. 1 : <i>High speed link</i> among PLCs of Fnet	6-23
6.2.10	Ex. 2 : <i>High speed link</i> of master + remote I/O stations in Fnet	6-26

6.3	<i>Function block service</i>	6-28
6.3.1	Introduction	6-28
6.3.2	Programming procedure of <i>function block</i>	6-28
6.3.3	Types of <i>function block</i>	6-29
6.3.4	Input/output of <i>function block</i>	6-29
6.3.5	How to use <i>function block</i>	6-30
6.3.6	<i>Function block</i> library of link	6-31
	CONNECT	6-33
	RDARRAY	6-36
	WRARRAY	6-38
	RDBLOCK	6-40
	WRBLOCK	6-42
	RDTYPE(BOOL ..DT)	6-44
	WRTYPE(BOOL ..DT)	6-47
	STATUS	6-49
6.3.7	Error received from communication module	6-55
6.3.8	Access variable registration	6-57
6.4	GMWIN remote connection service	6-62
6.4.1	Introduction	6-62
6.4.2	GMWIN remote connection	6-63
6.4.3	Remote module information	6-70
6.5	<i>Function block service for FSM(Fnet Slave Module)</i>	6-72
6.5.1	<i>Function blocks</i> of special slave module	6-72
6.5.2	<i>Function blocks</i> of reading/writing in slave module	6-79
6.6	Use of communication module flag	6-81
6.6.1	Types of flags	6-81
6.6.2	Major flag types used in Fnet	6-82
6.6.3	How to use flag in GMWIN	6-83
6.6.4	Example of remote I/O reset program using _FSMx_RESET/_FSMx_IO_RESET	6-84
6.6.5	Example of application program for restoring instant power off in the remote module	6-86
6.6.6	Special module access by using _NETx_LIV[n] and _NETx_RST[n]	6-87
6.6.7	Setting emergency output data of remote module	6-90

Chapter 7 Diagnosis function

7.1	Self diagnosis function of Fnet communication module	7-1
7.1.1	Self diagnosis function during running	7-1
7.1.2	Communication diagnosis by test mode	7-1

7.2	Mnet diagnosis function	7-3
7.2.1	Diagnosis function types of Mnet communication module	7-3
7.2.2	How to diagnose Mnet communication module	7-3

Chapter 8 Installation and testing operation

8.1	Installation and testing operation of Fnet communication module	8-1
8.1.1	Installation of Fnet master module	8-1
8.1.2	Installation of Fnet slave module	8-2
8.1.3	Installation procedure of Fnet module	8-3
8.1.4	Cautions on installation of Fnet module	8-4
8.1.5	Preparations during testing operation of Fnet module	8-6
8.1.6	Testing operation procedure of Fnet module	8-7
8.2	Installation and testing operation of Fnet option unit	8-9
8.2.1	Active coupler of Fnet.....	8-9
8.2.2	E/O converter(Electric/optical signal converter)	8-10
8.2.3	Repeater(Electric signal restructure)	8-11
8.3	Installation and testing operation of Mnet communication module	8-12
8.3.1	Mounting and installation	8-12
8.3.2	Cautions on system configuration.....	8-15
8.3.3	Preparations before testing operation.....	8-15
8.3.4	Procedure of testing operation	8-16
8.4	Repair and check	8-18
8.4.1	Daily check	8-18
8.4.2	Regular check	8-19

Chapter 9 Troubleshooting

9.1	Abnormal operations	9-1
9.2	Troubleshooting by each error code	9-3
9.2.1	Error code E00-01 : Hardware error	9-3
	Error code E00-03 : Hardware error of option module.....	9-3
9.2.2	Error code E00-02 : Interface error	9-4
9.2.3	Error code E00-04 : I/O initialization error of FSM(Fieldbus Slave Module)	9-5
9.2.4	Error code E01-01 : Communication failure in Fnet	9-6
	Error code E01-02 : Communication failure in Mnet	9-6
	Error code E01-03 : Communication failure in FOU group	9-6
9.2.5	Error code E02-01 : PLC interface error during operation	9-7
9.2.6	Error code E02-02 : Slave mounting and writing interface error during operation	9-8
9.2.7	Error code E03-01 : <i>High speed link</i> parameter error	9-9

9.2.8	Error code E03-02 : <i>High speed link</i> not run	9-10
9.2.9	Error code E03-03 : RUN link contact of <i>high speed link</i> not ON	9-11
9.2.10	Error code E03-04 : Trouble contact of <i>high speed link</i> ON	9-12
9.2.11	Error code E04-01 : Execution error of Fnet communication command	9-13
	Error code E04-02 : Execution error of Mnet communication command	9-13
9.2.12	Error code E05-01 : Time out error in GMWIN communication	9-14
9.2.13	Error code E05-02 : Internal error in the Fnet/Mnet GMWIN communication	9-15

Appendix

A1.	LED specifications	A-1
A1.1	LED specification of Fnet master module	A-1
A1.2	LED specification of slave module	A-4
A1.3	LED specification of stand-alone type remote module(G0L-SMQA/SMIA/SMHA)	A-7
A1.4	LED specification of repeater module(G0L-FREA)	A-7
A1.5	LED specification of electric and optical signal switching module(G0L-FOEA)	A-7
A1.6	LED specification of active coupler module(Optical signal distributor)	A-7
A1.7	LED specifications of Mnet communication module	A-8
A2.	Communication module setting in the Fnet/Mnet PC	A-10
A3.	STATUS code value and description for <i>function block</i>	A-11
A3.1	Errors received from communication module	A-11
A3.2	STATUS values indicated in CPU	A-12
A4.	Outward dimension	A-13
A4.1	For mounting GM1/2/3	A-13
A4.2	For mounting GM4	A-15
A4.3	For mounting on GM6	A-16
A4.4	For mounting on PC(Computer)	A-17
A4.5	Fnet option module	A-18

Chapter 1 Introduction

This User's Manual describes for the entire network of GLOFA PLC system technically and in detail. Network of GLOFA PLC system consists of GLOFA Mnet and GLOFA Fnet according to the type of the unit and the application, and the characteristics are as follows :

GLOFA Mnet

This is based on international standard network of factory automation, Mini-MAP(FAIS2.0) and situated at medium level of CIM network structure connecting medium/super controller(GM1, GM2, GM3 PLC) and medium/micro PC each other, and this is open network system for data communication of massive capacity and real time communication. This network is based on the international standard and can be connected easily with other company's communication module by simple parameter setting only.

GLOFA Fnet

This is situated at lower level of CIM network structure, and an open network system based on IEC/ISA Fieldbus of which standardization is in proceeding. Main characteristics of this network are reduction of the price for installation and maintenance, variety of system configuration, ease of maintenance and repair, and ease of system modification. This network supports electric network(twisted pair cable) which is cheap and easy to install and optical network(optical cable) which has great performance at the place that electric environment is very poor, for variety of system configuration. This also provides the option module that is composed of repeater, optical/electric converter, and active coupler, in order to combine suit ably these two networks according to the use.

Remark

1. GLOFA Mnet and GLOFA Fnet are abbreviated as Mnet and Fnet for simplicity of description.
2. Program in this User' s Manual has been prepared on the basis of GMWIN2.0.

1. Introduction

Modules configuring GLOFA Mnet and GLOFA Fnet are classified as Table 1.1 according to the cable used. This may be referred to when user configures network.

Table 1.1 Type of GLOFA PLC communication module

Network	Module	Type of connection cable	Name of communication module		Mounting base
GLOFA Mnet	Computer Module	Coaxial	Interface	G0L-MJEA	Computer GM1, GM2, GM3
				G3L-MJEA	
GLOFA Fnet	Master module (FMM)	Twisted pair (electric)	Interface	G0L-FJEA	Computer
				G3L-FJEA	GM3
				G4L-FJEA	GM4
				G5L-FJEA	GM5
				G6L-FJEA	GM6
		G3L-FJOA		GM1, GM2, GM3	
	Slave module (FSM)	Twisted pair (electric)	Remote I/O	G3L-RBEA	GM3
				G4L-RBEA	GM4
		Optical		G0L-SMQA	Single
				G0L-SMIA	Single
				G0L-SMHA	Single
	Option module	Twisted pair	Repeater	G0L-FREA	Single
		Optical/Twisted pair	Optical/electric converter	G0L-FOEA	Single
				Optical	Active coupler
		G0L-FAPA			
G0L-FABA					

Chapter 2 Terms and concepts of communication

2.1 Description of terms

Master module(Fnet Master Module ; FMM)

Fnet communication module mounted at I/O position of main base.

Slave module(Fnet Slave Module; FSM)

Fnet communication module and stand-alone module mounted at CPU position of main base.

Option module(Fnet Option Module)

Fnet communication module used for signal conversion, extension of communication distance, and regeneration and amplification of signal.

MCM communication module(Mnet Communication Module)

Mnet communication module mounted at I/O position of main base.

Local station

The station that GMWIN is directly connected in order to download, monitor, and debug programs in the same network including CPU.

Remote station

The opposite concept to local station, the other station to communicate with local station

Remote I/O station

Input/output area that the remote communication module of PLC system instead of CPU of PLC refreshes I/O module mounted on remote station by receiving I/O data from master station.

Mnet

This can be compared with the full map, which accommodates all of the concept and functions of the structure of seven layers suggested by OSI(Open Systems Interconnection). The specification consists of two lower layers(physical layer, data link layer) for the factory automation which demands reliability, rapid response, and real time control, one layer for application, and user layer for interface with user.

Fnet

Fieldbus is the lowest network connecting control device and instrumentation device, and the specification adopts three layers from seven layers of OSI. Three layers consist of the physical layer which consists of H2(1Mbps, electric), H1(31.23Kbps, electric), optical, and wireless, etc., the data link layer which adopts scheduled and circulated token bus, the application layer which plays a role of application, and additional user layer.

TAP

The coaxial line distributor that branches communication line to connect with several stations from one communication line in GLOFA Mnet.

Token

The right to transmit data of self station through controlling the right of accessing to physical medium.

SAP(Service Access Point)

The factor to determine the characteristic of service used in communication, and to connect upper application layer with data link layer according to their characteristics. LSAP is divided into SSAP, which is SAP's own station and DSAP, which is SAP of other station. (LSAP = SSAP + DSAP, used for Mnet only)

Mnet station number

The unique station number of G3L-MUEA and G0L-MUEA communication module adopting Mini-MAP specification. This station number uses MAC address of 6 byte as Mnet station number according to communication specifications, and this is used as Mnet station number for all services except *high speed link*. The station number switch attached on the front of communication module is a *high speed link* station number of two byte used in *high speed link* service only. (*High speed link* is used in communication with GLOFA product only)

Fnet station number

The station number of communication module(G3L-FUEA,... etc.) adopting Fnet specification. The station number used in Fnet is set by the switch attached on the front of communication module, and used as station number of all services including *high speed link* service differently from the station number used for Mnet.

Active coupler

This is a module connecting optical module each other when optical network is configured, and the optical distributor, which has function of regeneration and amplification of optical communication signal additionally.

Repeater

This is used to extend the distance of cable for electric communication network, extends the distance of communication with regeneration and amplification of electric communication signal.

E.O.C(Electric/Optical Converter)

This module converts optical communication signal to electric communication signal, or electric communication signal to optical communication signal, and has additional functions of regeneration and amplification of signal.

Manchester Biphase-L

Data modulation method used in Fnet. Data is encoded and transmitted by using Manchester-I code, Received data encoded by Manchester will be decoded and converted.

CRC(Cyclic Redundancy Check)

This is the one of error detection methods, which is an error detection method used most frequently for synchronizing transmission, and also called as cyclic code method.

Terminal resistance

This is used to adjust mutual impedance of transmitting part and receiving part on physical layer, and terminal resistance of Fnet is 110Ω , $1/2W$ and terminal resistance of Mnet is 75Ω , $1/4W$.

High speed link

This is used among GLOFA PLC communication modules only, and used to transmit and receive data at high speed, and executes communication by setting *high speed link* parameter of GMWIN.

GMWIN(Programming and debugging tool)

This software enables user to program in order to fit to the system, and to download, run, stop, and debug in GLOFA PLC CPU module.

FAM(FA Manager)

This software package is situated at upper level in factory automation, and enables user to connect with networks of several types, and enables user to execute *high speed link*, reading/writing variable, and download/upload program by mounting Fnet or Mnet module of computer.

Segment

Local network which connects all stations by using the same token, without using any connecting device(Gateway, EOC, Repeater).

Network

Entire communication system, configured by one segment or more, that uses the same token.

2.2 Concept of Fnet communication

The method of Fnet communication is token distribution method by LAS(Link Active Scheduler). One of FMM communication modules can be LAS, but FSM communication modules cannot be LAS.

2.2.1 How to generate and move LAS

Among communication modules, LAS can be generated under the following conditions :

- 1) Among the stations connected to network, FMM communication module that the power is turned on first obtains LAS.
- 2) When the power become on at the same time among the stations connected to network, the communication module with the lowest station number obtains LAS.
- 3) If the present LAS station becomes down during normal communication, the communication module of the lowest station number among the rest of FMM station, obtains LAS.
- 4) Only one LAS exists through the entire network.

2.2.2 How to assign token(Suppose that the Station FMM_01 is LAS)

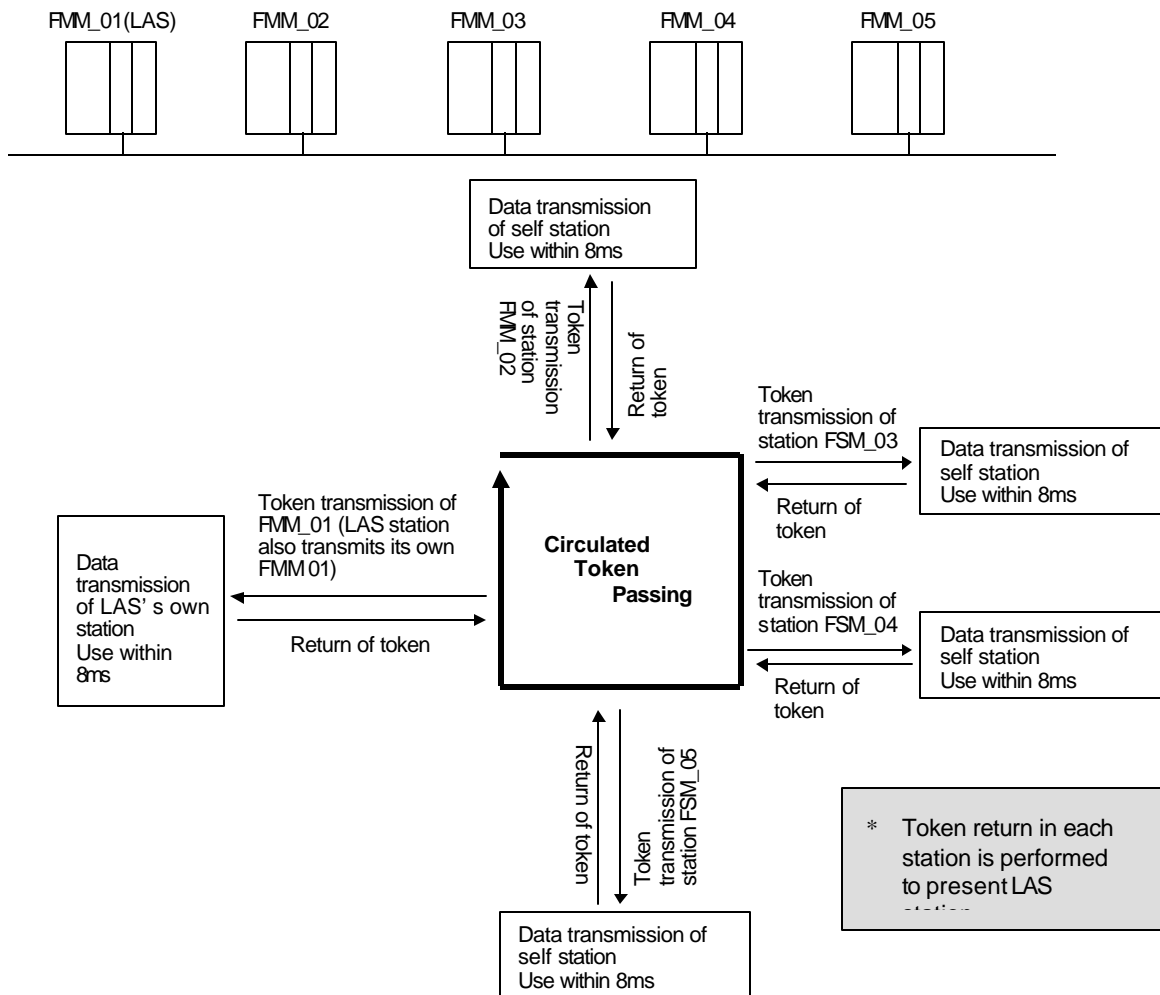

2.3 Concept of Mnet communication

Mnet communication method executes communication by using token passing method of IEEE 802.4.. In this method, a station receives the token transmitted from other station, transmits data of self station, and hands the token to next station.

2.3.1 How to generate and move token

- 1) Among the stations connected to network, communication module that the power is turned on first obtains token.
- 2) When the power is turned on at the same time among the stations connected to network, the communication module with the highest station number obtains token.
- 3) The station that generated token first, hands the token to the next station found, and stores the station number.
- 4) If the station that the token exists presently becomes down, the next highest station module generates token newly.
- 5) Only one token exists through the entire network.

2.3.2 Token Passing

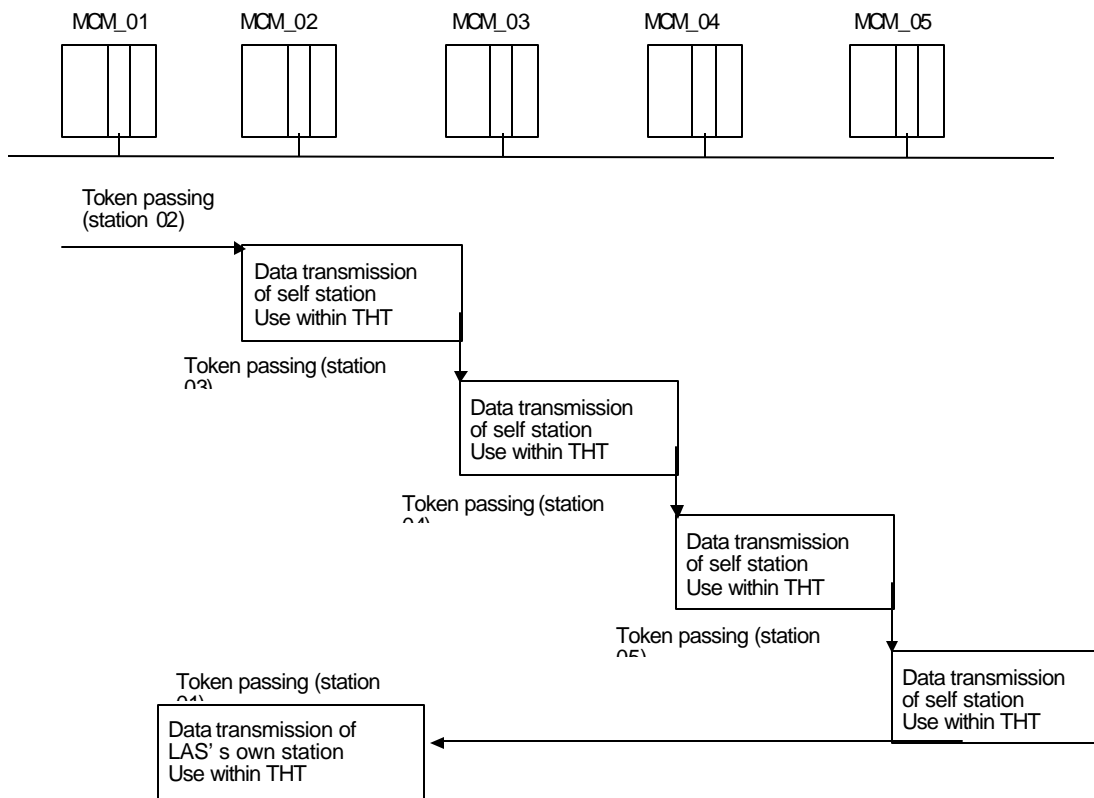

THT : Token Hold Time(The time that one station can use token, which is set in network parameter. Default : 2.3 ms).

Chapter 3 General specifications

3.1 General specifications of communication module(Fnet, Mnet)

General specifications of GLOFA-GM series are as follows :

Table 3.1 General specification

No.	Item	Spec.				Related spec.
1	Operating temp.	0 +55				
2	Storage temp.	-25 +75				
3	Operating moist.	5~95% RH, non-condensing				
4	Storage moist.	5~95% RH, non-condensing				
5	Vibration	For discontinuous vibration				ICE 1131-2
		Frequency 10 f<57Hz	Acceleration -	Amplitude 0.075mm	Number Each 10 times in X,Y,Z directions	
		57 f<150Hz	9.8 m/s ² {1G}	-		
		For continuous vibration				
		Frequency 10 f<57Hz	Acceleration -	Amplitude 0.035mm		
		57 f<150Hz	4.9 m/s ² {0.5G}	-		
6	Impact	<ul style="list-style-type: none"> Max. impact acceleration:147 m/s²(15G) Authorized time : 11ms Pulse wave : Sign half-wave pulse(each 3 times in X,Y,Z directions) 				IEC 1131-2
7	Noise	Square wave Impulse noise	± 1,500V			Test spec. reference within LG Industrial Systems
		Static electric discharging	Voltage : 4kV(Contact discharging)			IEC 1131-2, IEC 801-2
		Radiation electric field noise	27-500 MHz, 10V/m			IEC 1131-2, IEC 801-3
		Fast transient/burst noise	Segment	Power module	Digital input/ output (24V or more)	Digital input/output (less than 24V)Analog input/output communication interface
	Voltage	2kV	1kV	0.25 kV		
8	Ambient conditions	No corrosive gas and dust				
9	Height	Up to 2,000m				
10	Pollution level	2 or less				
11	Cooling type	Natural air cooling				

Remark

1. IEC(International Electro-technical Commission) : International non-governmental association, which establishes international standards in the field of electric and electronics.
2. Pollution level : This is an indication showing pollution of surrounding environment, which determines insulation performance of device, and generally the pollution level 2 means the conditions in which only non-conductive pollution occurs.
But, temporary conduction may occur according to condensing.

3.2 Structure and configuration

This describes the structure and configuration for representative type of Fnet and Mnet module.

3.2.1 Fnet master module structure : G3L-FUEA, G3L-FUOA, G4L-FUEA, G6L-FUEA

1) G3L-FUEA, G3L-FUOA, G4L-FUEA

Ex. of G3L-FUEA

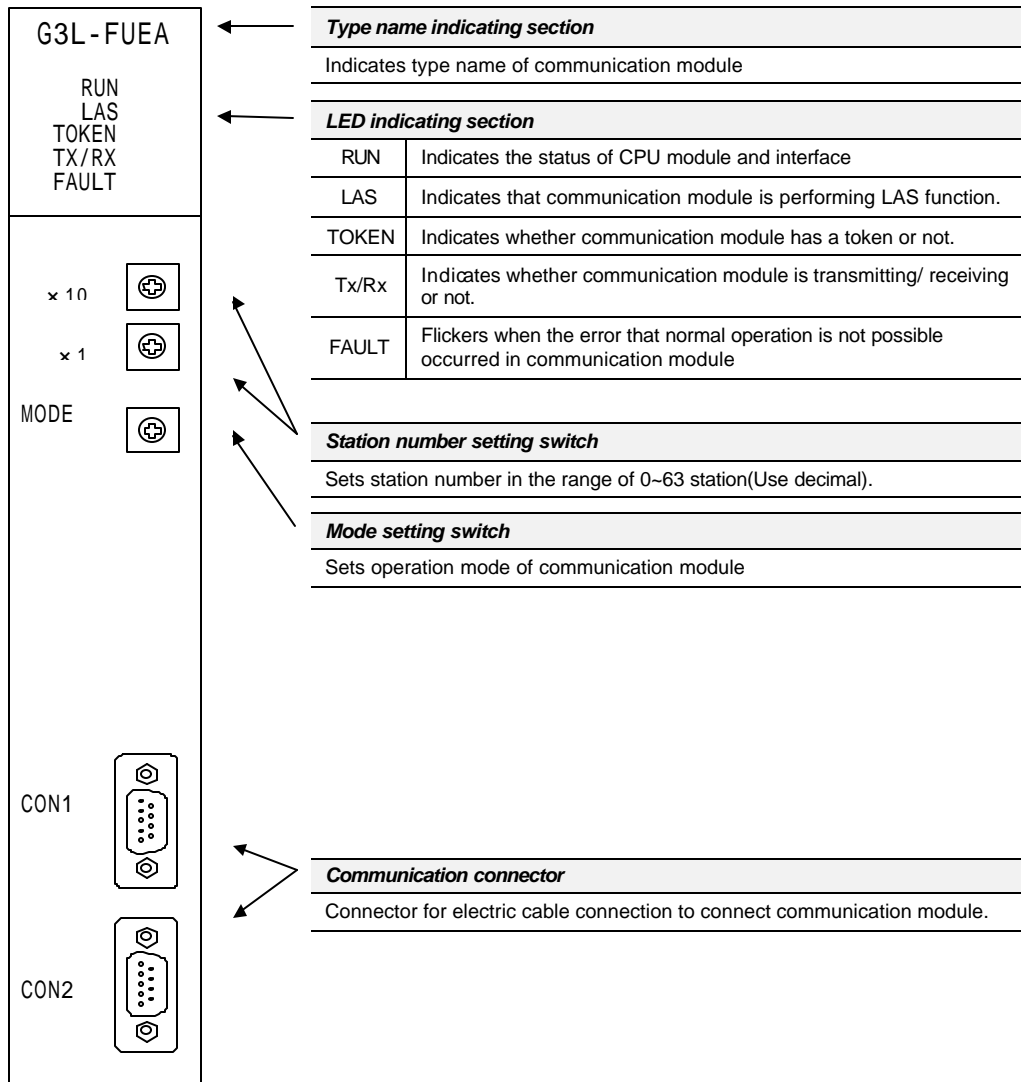

Remark

1. In the figure shown above, connector of G3L-FUOA is made of optical connector.
2. For mode setting switch, see 3.2.6 Fnet mode setting.

2) G6L-FUEA

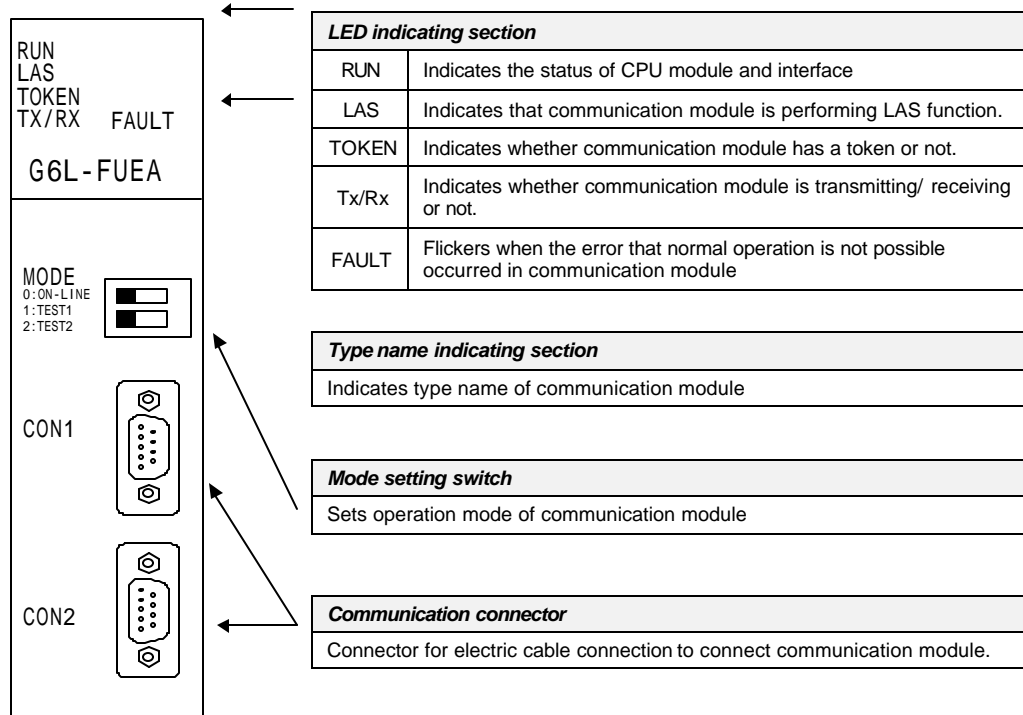

Remark

1. The station number setting switch is placed in the case.

3. General specifications

3.2.2 Fnet slave module structure : G3L-RBEA, G3L-RBOA, G4L-RBEA

1) Front part(Ex. G3L-RBEA)

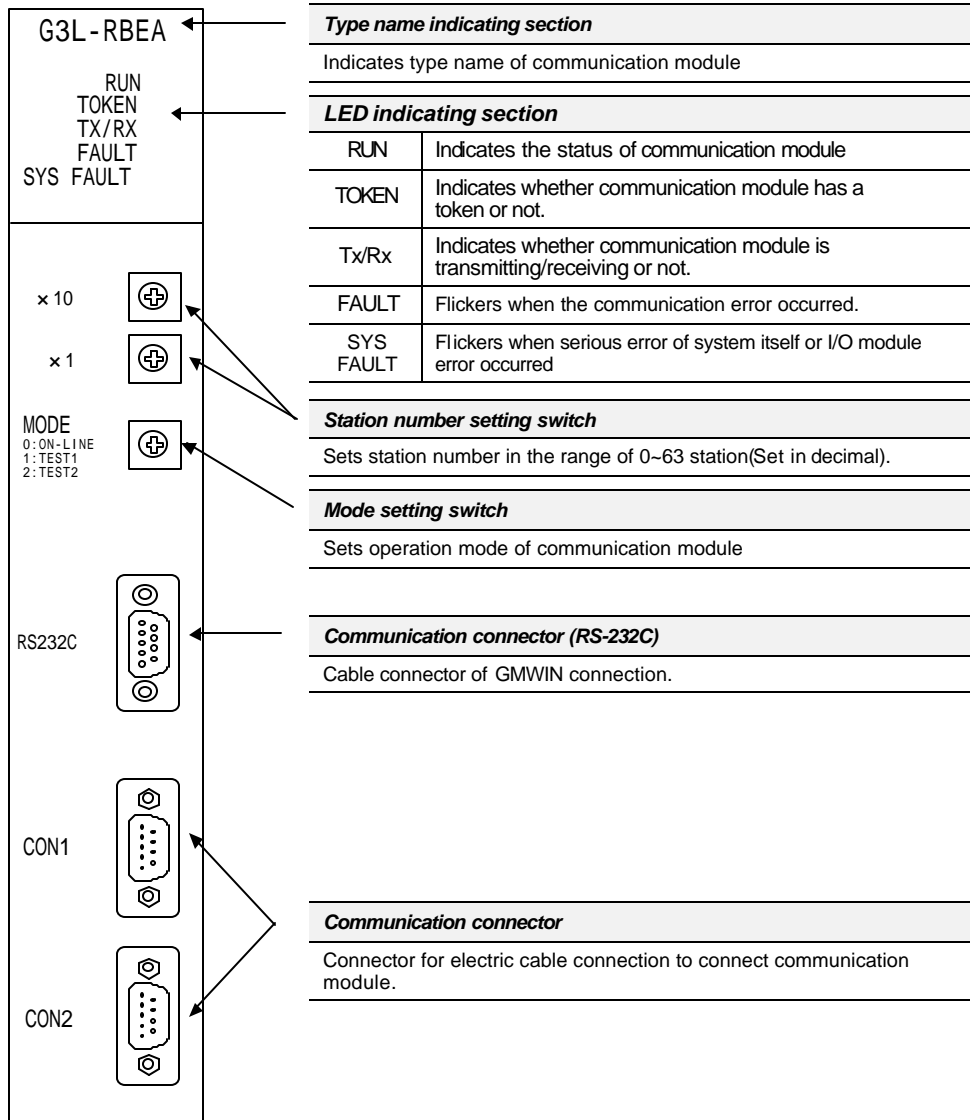

Remark

In the figure shown above, connector of G3L-RBOA is made of optical connector, and there is no RS-232C port in G4L-RBEA.

2) Side part(Ex. G3L-RBEA)

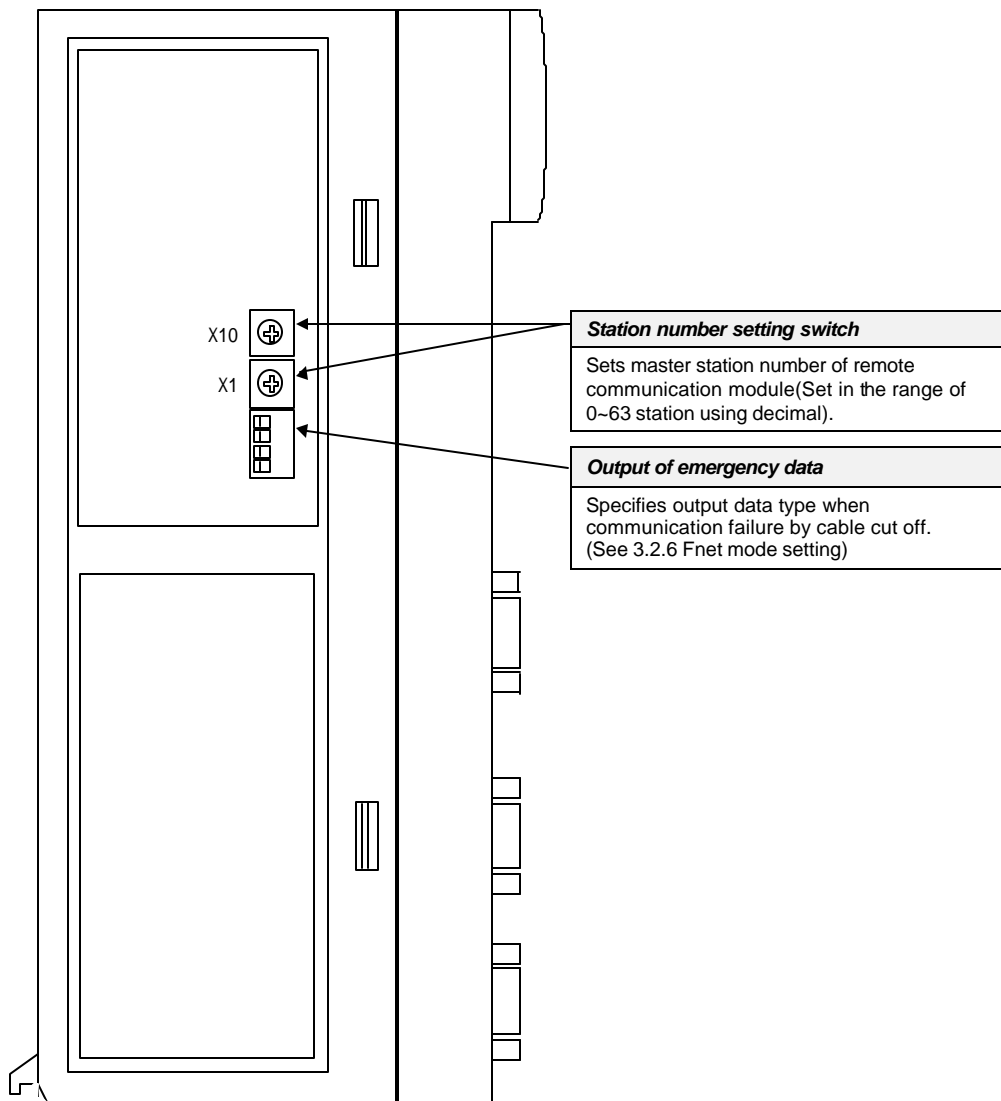

3. General specifications

3.2.3 Fnet Computer interface module structure : G0L-FUEA

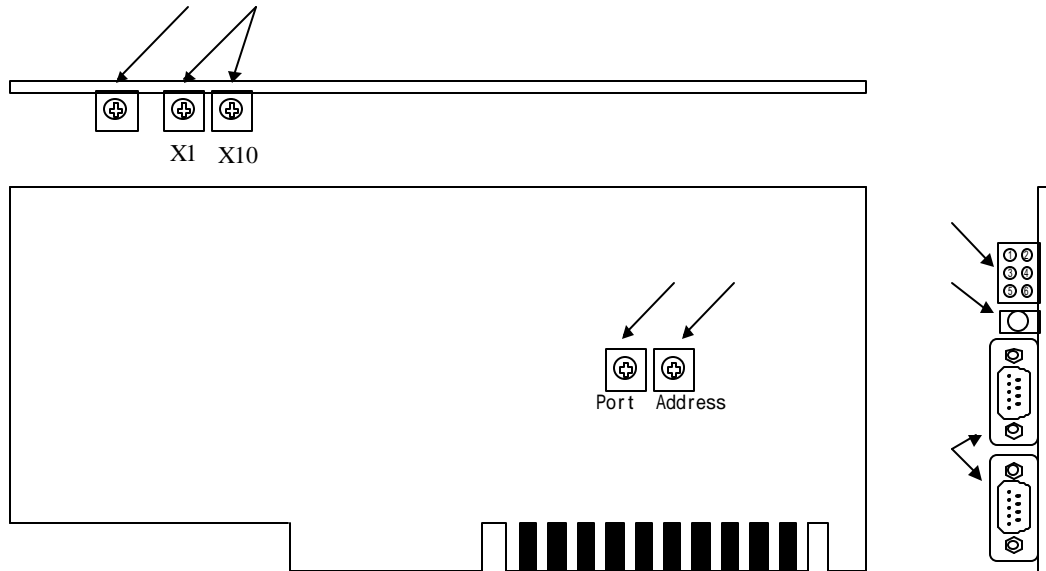

	Port selection	Address selection
0	3E0	FC00
1	3C0	F800
2	3A0	F400
3	380	F000
4	360	EC00
5	340	E800
6	320	E400
7	300	E000
8	2E0	DC00
9	2C0	D800
A	2A0	D400
B	280	D000
C	260	CC00
D	240	C800
E	220	C400
F	200	C000

LED indicating section		
No.1	POWER	Indicates whether power is being supplied to communication module
No.2	RUN	Indicates the status of CPU module and interface
No.3	LAS	Indicates that communication module is performing LAS function.
No.4	TOKEN	Indicates whether communication module has token or not.
No.5	Tx/Rx	Indicates whether communication module is transmitting/receiving or not.
No.6	FAULT	Flickers when the error that normal operation is not possible occurred in communication module
Station number setting switch		
Sets station number in the range of 0~63 station(Set in decimal).		
Mode setting switch		
Sets operation mode of communication module		
Reset switch		
A switch to initialize communication module		
Communication connector		
Connector for electric cable connection to connect communication module.		

Remark

1. For mode setting switch, see 3.2.6 Fnet mode setting.
2. Port is set to No.5(340) and address is set to No.9(D800) by factory default.
3. This should be set in order not to be duplicated with other device area of computer previously used, and add `DEVICE=C:\WINDOWS\EMM386.EXE NOEMS X=D800-D8FF`(if address has been set to No.9(D800)) in `CONFIG.SYS` to use set area for not continuous or extended area of computer but this module.

3.2.4 Fnet LED signal name and indication content

Device type	LED Name	Meaning of LED indication	LED On	LED Off
G3L-FUEA G3L-FUOA G4L-FUEA G6L-FUEA GOL-FUEA	RUN	Indicates the status of CPU module and interface	Normal	Abnormal
	LAS	Indicates that communication module is performing LAS function.	In proceeding	
	TOKEN	Indicates whether communication module has token or not.	Has	Does not have
	Tx/Rx	Indicates whether communication module is transmitting/receiving or not.	Flicker during communication	
	FAULT	Indicates the status of communication module.	Abnormal	Normal
G3L-RBEA G3L-RBOA G4L-RBEA	RUN	Indicates the status of communication module.	Normal	Abnormal
	TOKEN	Indicates whether communication module has token or not.	Has	Does not have
	Tx/Rx	Indicates whether communication module is transmitting/receiving or not.	Flicker during communication	
	FAULT	Indicates whether communication error exists or not.	Abnormal	Normal
	SYS FAULT PWR	Indicates whether system error or I/O module error occurred or not. Indicates power status.	Abnormal Power On	Normal Power Off
GOL-SMQA GOL-SMIA GOL-SMHA	TRX	Indicates Tx/Rx or not of communication module.	Flicker during communication	
	ERR	Indicates communication error or not.	Abnormal	Normal

* For details on LED, see Appendix A1, LED indication.

3.2.5 Fnet station number setting

1) Local station number setting

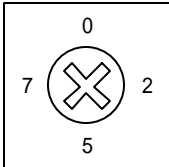
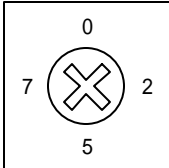
Applied Device type	Detailed drawing of station number switch	Description						
G3L-FUEA G3L-FUOA G3L-RBEA G3L-RBOA G4L-FUEA G4L-RBEA G6L-FUEA GOL-FUEA GOL-SMQA GOL-SMIA GOL-SMHA	<p>× 10</p>  <p>× 1</p> 	<p>(1) Station number can be set from 0 to 63(Decimal). (2) Station number setting (Factory default is 0)</p> <table border="1"> <thead> <tr> <th>Switch</th> <th>Setting</th> </tr> </thead> <tbody> <tr> <td>X 10</td> <td>Sets ten' s figure of station number</td> </tr> <tr> <td>X 1</td> <td>Sets one' s figure of station number</td> </tr> </tbody> </table> <p>(3) GM6 : The station setting switch is placed in the case.</p>	Switch	Setting	X 10	Sets ten' s figure of station number	X 1	Sets one' s figure of station number
Switch	Setting							
X 10	Sets ten' s figure of station number							
X 1	Sets one' s figure of station number							

3. General specifications

2) Master station number setting

Sets station number of Fnet master module, which can transmit and receive *high speed link* data in Fnet slave module(Station number switch is located inside of case).

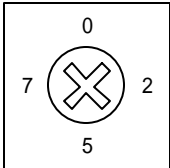
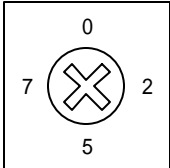
Applied Device type	Detailed drawing of station number switch	Description						
G3L-RBEA G3L-RBOA G4L-RBEA G0L-SMQA G0L-SMIA G0L-SMHA	<p>× 10</p>  <p>× 1</p> 	<p>(1) Station number can be set from 0 to 63(Decimal). (2) Station number setting (Factory default is 0)</p> <table border="1"> <thead> <tr> <th>Switch</th> <th>Setting</th> </tr> </thead> <tbody> <tr> <td>X 10</td> <td>Sets ten' s figure of station number</td> </tr> <tr> <td>X 1</td> <td>Sets one' s figure of station number</td> </tr> </tbody> </table>	Switch	Setting	X 10	Sets ten' s figure of station number	X 1	Sets one' s figure of station number
Switch	Setting							
X 10	Sets ten' s figure of station number							
X 1	Sets one' s figure of station number							

3.2.6 Fnet mode setting

1) Test mode

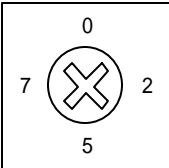
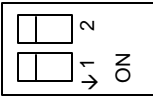
Applied Device type	Detailed drawing of mode switch	Description								
G3L-FUEA G3L-FUOA G3L-RBEA G3L-RBOA G0L-FUEA	<p>MODE</p> <p>0: ON LINE 1: TEST 1 2: TEST 2</p> 	<p>(1) Mode can be set from 0 to 2. (GM6 : 0 ~ 3) (2) Mode setting (Factory default is 0)</p> <table border="1"> <thead> <tr> <th>Mode</th> <th>Function</th> </tr> </thead> <tbody> <tr> <td>0</td> <td>Performs normal operation</td> </tr> <tr> <td>1</td> <td>Sets the unit as data transmitting station in communication test</td> </tr> <tr> <td>2</td> <td>Sets the unit as data transmitting station in communication test</td> </tr> </tbody> </table>	Mode	Function	0	Performs normal operation	1	Sets the unit as data transmitting station in communication test	2	Sets the unit as data transmitting station in communication test
Mode	Function									
0	Performs normal operation									
1	Sets the unit as data transmitting station in communication test									
2	Sets the unit as data transmitting station in communication test									
G4L-FUEA G4L-RBEA	<p>MODE</p> <p>0: ON-LINE 1: TEST1 2: TEST2</p> 	<p>* For details, see chapter 7, Diagnosis function.</p>								

2) Emergency data output setting

In Fnet slave module, when the communication with remote station is cut off by remote station error or line error during communication, setting of these switches specifies an operation between latching I/O data in slave module and outputting optional user-defined data.

Applied Device type	Detailed drawing of mode switch	Description							
G3L-RBEA G3L-RBOA		<table border="1"> <thead> <tr> <th>Mode</th> <th>Function</th> </tr> </thead> <tbody> <tr> <td> </td> <td>Latches the last data during communication error.</td> </tr> <tr> <td> </td> <td>Outputs user-defined data during communication error (Default is data reset).</td> </tr> </tbody> </table>	Mode	Function		Latches the last data during communication error.		Outputs user-defined data during communication error (Default is data reset).	
Mode	Function								
	Latches the last data during communication error.								
	Outputs user-defined data during communication error (Default is data reset).								
G4L-RBEA GOL-SMQA GOL-SMIA GOL-SMHA		<table border="1"> <thead> <tr> <th>Mode</th> <th>Function</th> </tr> </thead> <tbody> <tr> <td> </td> <td>Latches the last data during communication error.</td> </tr> <tr> <td> </td> <td>Outputs user-defined data during communication error (Default is data reset).</td> </tr> </tbody> </table>	Mode	Function		Latches the last data during communication error.		Outputs user-defined data during communication error (Default is data reset).	
Mode	Function								
	Latches the last data during communication error.								
	Outputs user-defined data during communication error (Default is data reset).								

Remark

1. All of the switches are set to off by factory default.
2. User can input user-defined data for communication error in GMWIN *function block* program.
(Refer to 6.6.7, Setting emergency output data of remote module.)

3. General specifications

3.2.7 Mnet module structure : G3L-MUEA

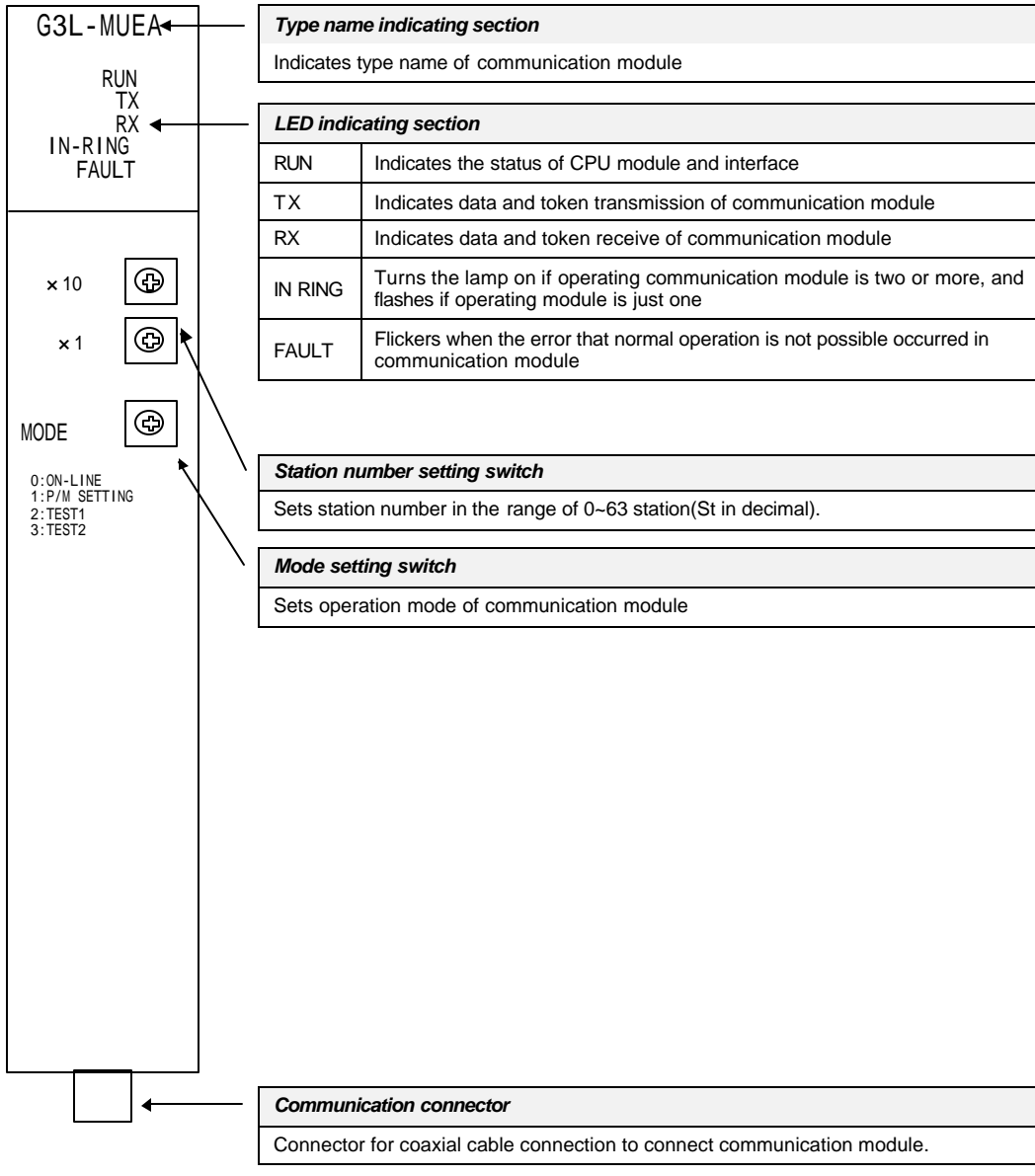

Mode setting

Applied device type	Detailed drawing of mode switch	Description										
G3L-MUEA G0L-MUEA	<p>MODE</p> <p>0: ON LINE 1: P/M SETTING 2: TEST1 3: TEST2</p>	<p>(1) Mode can be set from 0 to 2.</p> <p>(2) Mode setting (Default is 0)</p> <table border="1"> <thead> <tr> <th>Mode</th> <th>Function</th> </tr> </thead> <tbody> <tr> <td>0</td> <td>Performs normal operation</td> </tr> <tr> <td>1</td> <td>Used for parameter setting of GMWIN</td> </tr> <tr> <td>2</td> <td>Sets when communication module is tested</td> </tr> <tr> <td>3</td> <td>Reservation(presently not available)</td> </tr> </tbody> </table>	Mode	Function	0	Performs normal operation	1	Used for parameter setting of GMWIN	2	Sets when communication module is tested	3	Reservation(presently not available)
Mode	Function											
0	Performs normal operation											
1	Used for parameter setting of GMWIN											
2	Sets when communication module is tested											
3	Reservation(presently not available)											

3.2.8 Mnet computer interface module structure : GOL-MUEA

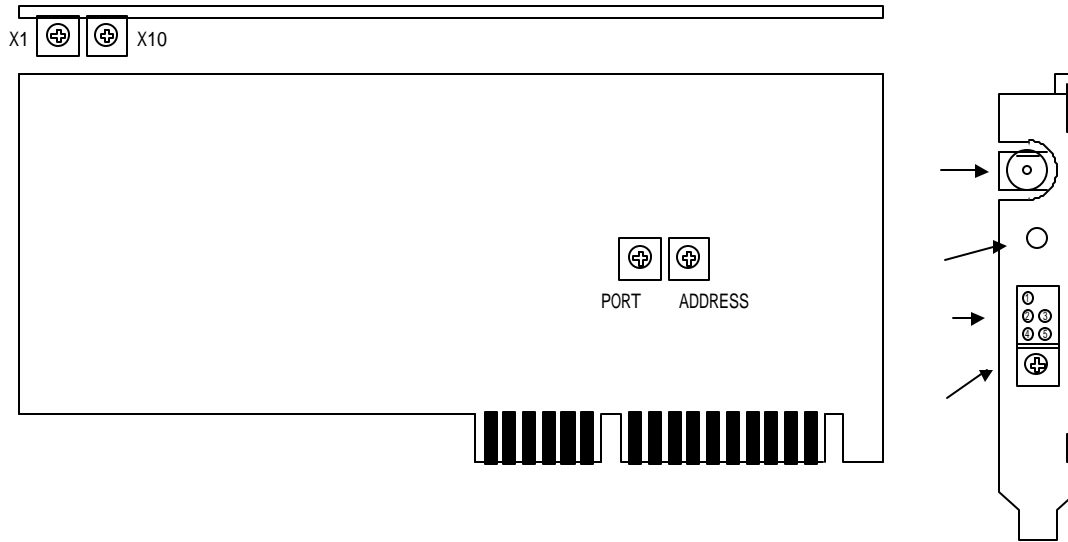

	Port select-ion	Address select-ion
0	3E0	FC00
1	3C0	F800
2	3A0	F400
3	380	F000
4	360	EC00
5	340	E800
6	320	E400
7	300	E000
8	2E0	DC00
9	2C0	D800
A	2A0	D400
B	280	D000
C	260	CC00
D	240	C800
E	220	C400
F	200	C000

LED indicating section		
No.1	RUN	Indicates the status of IBM compatible PC and interface
No.2	TX	Indicates data and token transmission of communication module
No.3	RX	Indicates data and token receive of communication module
No.4	IN-RING	Lights on if operating communication module is two or more, and flashes if operating module is just one
No.5	FAULT	Flashes when the error that normal operation is not possible occurred in communication module

Station number setting switch
Sets station number in the range of 0-63 station(Set in decimal).

Mode setting switch
Sets operation mode of communication module(see 3.2.7 G3L-MUEA structure)

Reset switch
A switch to initialize communication module

Communication connector
Connector for coaxial cable connection to connect communication module.

Remark

1. Port is set to No.5(340) and address is set to No.9(D800) by factory default.
2. This should be set in order not to be duplicated with other device area previously used, and add DEVICE=C:\WINDOWS\EMM386.EXE NOEMS X=D800-D8FF(if address has been set to No.9(D800)) in CONFIG.SYS to use set area for not continuous or extended area of computer but this module.

Chapter 4 Transmission specifications

4.1 Transmission specifications of Fnet

4.1.1 Transmission specifications of Fnet master module

Product of Fnet master module : G3L-FUEA, G3L-FUOA, G4L-FUEA, G5L-FUEA, G6L-FUEA, G0L-FUEA

Table 4.1.1 Transmission specifications of Fnet master module

Item		Specification
Transmission speed		1Mbps common in Fnet module
Encoding type		Manchester Biphase-L
Electric	Transmission distance (per segment)	Max. 750m
	Transmission distance (during using repeater)	Max. 750m × (6 repeater + 1) = 5.25 km
	Transmission line	Twisted pair shielded cable
Optical	Transmission distance (per segment)	Max. 3km
	Transmission distance (during using EOC)	Max. 3km × (6 EOC + 1) = 21km
	Transmission line	Optical cable
Max. number of station connection		Master + slave = 64 station (At least one master should be connected)
Max. size of protocol		256 byte
Access type of communication right		Circulated token passing
Communication type		Connection oriented service Connectionless service
Frame error check		$CRC\ 16 = X^{15} + X^{14} + X^{13} + \dots + X^2 + X + 1$

4. Transmission specifications

4.1.2 Transmission specifications of Fnet slave module

Product of Fnet slave module : G3L-RBEA, G3L-RBOA, G4L-RBEA, G0L-SMQA, G0L-SMIA, G0L-SMHA

Table 4.1.2 Transmission specifications of Fnet slave module

Item	Specification	
Transmission speed	1Mbps	
Encoding type	Manchester Biphase-L	
Electric	Transmission distance (per segment)	Max. 750m
	Transmission distance (during using repeater)	Max. 750m × (6 repeater + 1) = 5.25 km
	Transmission line	Twisted pair shielded cable
Optical	Transmission distance (during segment)	Max. 3km × (6 EOC + 1) = 21km
	Transmission line	Optical cable
Max. number of stations connected	Link master class + Remote slave class = 64	
Max. size of protocol	256 byte	
Access type of communication right	Circulated token passing	
Communication type	Connection oriented service Connectionless service	

4.1.3 Transmission specifications of Fnet option module

Product of Fnet option module : G0L-FREA, G0L-FOEA, G0L-FACA

1) Repeater (G0L-FREA)

Table 4.1.3(A) Transmission specifications of repeater

Item	Specification
Communication speed	1Mbps
Encoding type	Manchester Biphase-L
Transmission line(Cable)	Twisted pair shielded cable
Max. extension distance per module	750m
Max. number of repeater between stations	6 units
Max. distance between stations	5.25km(when 6 repeater is installed)
Frame error check	CRC 16 = $X^{15} + X^{14} + X^{13} + \dots + X^2 + X + 1$

2) Electric/Optical converter (G0L-FOEA)

Table 4.1.3(B) Transmission specifications of electric/optical converter

Item	Specification
Communication speed	1Mbps
Encoding type	Manchester Biphase-L
Transmission line(Cable)	Optical cable, twist pair cable
Max. transmission distance	3km(Optical)/750m(electric)
Function of signal regeneration	Regenerating, Reshaping function
Frame error check	$CRC\ 16 = X^{15} + X^{14} + X^{13} + \dots + X^2 + X + 1$

3) Active coupler (Product : G0L-FACA)

Table 4.1.3(C) Transmission specification of active coupler

Item	Specification
Communication speed	1Mbps
Encoding type	Manchester Biphase-L
Transmission line(Cable)	Optical cable
Max. transmission distance	3km
Function of signal regeneration	Regenerating, Reshaping function
Frame error check	$CRC\ 16 = X^{15} + X^{14} + X^{13} + \dots + X^2 + X + 1$

4.2 Transmission specifications of Mnet

Table 4.2 Transmission specification of Mnet

Item	Specification
Communication line	75Ω coaxial cable (RG-6 / RG-11)
Max. number of stations connected	Max. 64 station
Communication speed	5 Mbps
Connection connector	75Ω female F series
Modulation type	Phase lock FSK (Frequency Shift Keying)
Transmission distance	Max. 900m
Max. protocol length	1 kbyte
Error detection	FCS(CRC 32 type)
Access type of communication right	Token passing bus type

4.3 Cable specifications

4.3.1 Twisted pair cable for Fnet

Type name of product : G0C-T (is length of cable, unit : m)
 Ex.) Twisted pair cable 10m : G0C-T010

Table 4.3.1 Specifications of twisted pair cable for Fnet

Cable contents			
Product name	Low Capacitance LAN Interface Cable		
Type name	LIREV-AMESB		
Size	2 × 1.0mm (GS 92-3032, 18 AWG)		
Maker	LG CABLE CO.,LTD		
Electric characteristics			
Item	Unit	Characteristic	Test Condition
Conductor resistance	Ω/km	21.8 or less	Normal Temp.
Withstanding voltage(DC)	V/min	Withstands at 500V for 1 minute	In air
Insulation resistance	MEGA.Ω-km	1,000 or more	Normal Temp.
Static electricity capacity	pF/m	45 or less	1 kHz
Characteristic impedance	Ω	120 ± 12	10 MHz
Characteristics in appearance			
Conductor	Number of core	CORE	2
	Specification	AWG	18
	Configuration	NO/mm	1/1.0
	Outer diameter	mm	1.0
Insulator	Thickness	mm	0.9
	Outer diameter	mm	2.8

- Structural drawing

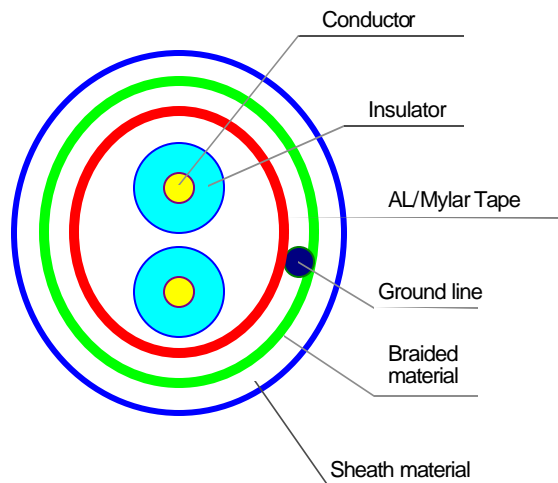

4. Transmission specifications

4.3.2 Optical cable for Fnet

Type name : G0C-F (is length of cable, unit : m)

Ex.) Optical cable 10m : G0C-F010

Table 4.3.2 Specifications of optical cable

Cable contents	
Type name	Y22 : For indoor (for Bi-directional communication) D22 : For outdoor (for Bi-directional communication)
Connector type	ST - Type
Maker	Hewlett Packard(H.P)

Segment	For indoor(standard)		For outdoor(standard)	
	Y22		D22	
Outer diameter (mm)	2.9 × 5.8		4.8	
Min. Radius of curvature	Loaded (cm)	5.0	7.5	
	Unloaded (cm)	3.0	4.8	
Weight(Kg/m)	16		21	

Contents	Characteristic	Unit
Core	62.5	μm
Cladding	125	μm
Max. attenuation	5	dB/km
Standard attenuation	4.5	dB/km

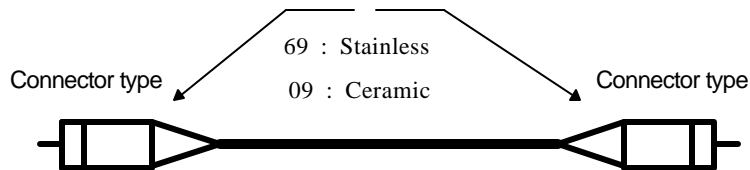

Ex.) If the cable type is Y226969, connector type is ST and the shape is stainless at both of the connectors.

● Outside drawing of optical cable

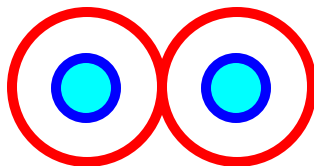

For indoor(Y22)

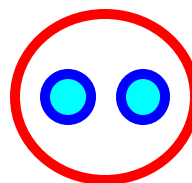

For outdoor(D22)

4.3.3 Coaxial cable for Mnet

1) **Cable**

When network is configured using Mnet communication module, RG-6(Drop cable) and RG-11(Trunk cable) which conform to IEEE 802.4 Carrier Band can be used. The following is specifications for RELCOM(USA) company product, so user may refer to the following.

Table 4.3.3(A) Cable specifications available in Mnet

Type	Attenuation distortion (dB/100m)		Distance(m)		Transmitting impedance Milli-ohm/meter max
	10MHz	20MHz	5Mbps	10Mbps	
RG-6(Drop) standard 5750	2.47	3.12	818	538	10
RG-11(Trunk) standard 5950	1.46	2.05	960	717	10

2) **Tap**

Tap is used to connect and to branch each station with trunk cable, and electric characteristic of Tap should be outstanding, and comply with specifications. The following is specifications of Tap(2-port and 4-port Tap) for RELCOM(USA) company product, so user may refer to the following.

Table 4.3.3(B) Tap specifications available in Mnet MCM group

Electric characteristic	CBT-2(2-port)	CBT-4(4-port)	Unit
Trunk to drop attenuation&distortion	20 ± 0.5	20 ± 0.5	dB min.
Trunk return loss	35	35	dB min.
Drop return loss	20	20	dB min.
Drop to drop Isolation	30	30	dB min.
Additional loss	0.3	0.5	dB min.

4.4 How to connect communication cable

4.4.1 Electric(twisted pair) cable connection

Cable for electric network connection uses only No.6 and No.7 of the connector pin, No.6 signal of communication module connector A is connected to No.6 of communication connector B, and No.7 of connector A is connected to No.7 of connector B. Body of connector(metal : electrically conductive) is connected with other module by shielding wire, and bypasses external noise, etc., so connector of both side should be connected with shielding wire, and contact with high voltage and high current should not be allowed. For treating shielding wire in connection of G0L-FUEA(PC attached Fnet module) connector, general communication module body must be connected with pin No.5 of G0L-FUEA like Figure 4.4.1.

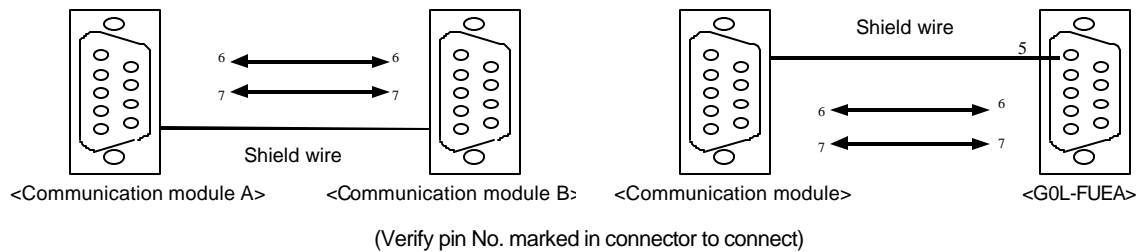

Fig. 4.4.1 Cable connection method of Fnet

4.4.2 Electric(twisted pair) cable connector connection

Connector is accessory parts which connects electric network of fieldbus module, and it should be connected as a method in Figure 4.4.2(A). It should be noted that shielding wire of cable should be connected to metal part of connector by soldering, and the other. Data transmission/receive is impossible if shielding wire is not connected(Shielding wire of G0L-FUEA should be connected to No.5 pin as shown in Fig.4.4.2(B) to prevent contact with computer body. Internally No.5 pin CON1 And CON2 are under short, so shielding wire is separated from computer body, and it is bypassed next connection station or terminal resistance).

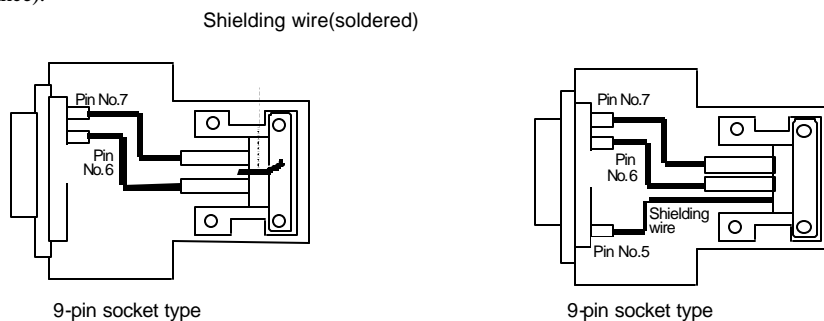
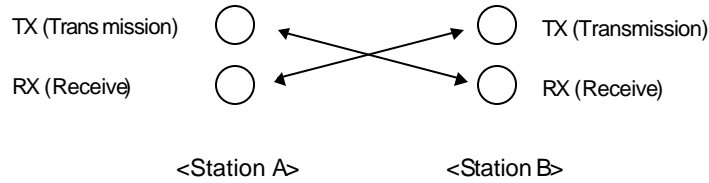

Fig. 4.4.2(A) Connection of Fnet connector Fig. 4.4.2(B) Connection of G0L-FUEA connector

4.4.3 Optical cable connection

Optical cable is connected by crossing transmission and receive line, i.e., RX of optical communication module A is connected to TX of optical communication module B, and TX of optical communication module A is connected to RX of optical communication module B.



4.5 Terminal resistance

4.5.1 Electric network terminal resistance of Fnet

- Resistance : 110 Ω , 1/2 W
- Connector case : Metal conductor plating type

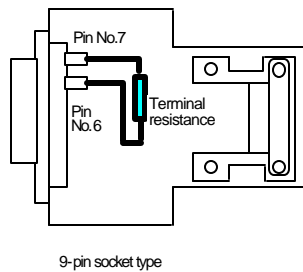

- ➔ Terminal resistance(110 Ω , 1/2W) of accessory parts(electric module only) should be attached at the start and end of network.
- ➔ Terminal resistance is attached inside of electric/optical converter(GOL-FOEA) and repeater(GOL-FREA) which are installed at terminal of electric network. Therefore, do not connect terminal resistance separately from external.
- ➔ Connector case should not be connected with terminal resistance.

4.5.2 Terminal resistance of Mnet

- Resistance : 75 Ω , 1/4 W
- Outside drawing of Mnet terminal resistance and TAB

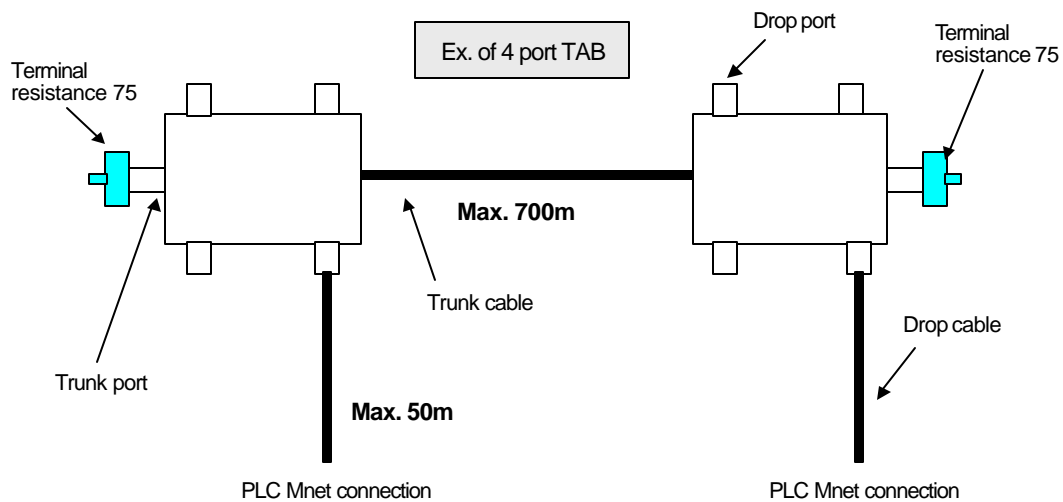

Chapter 5 Configuration

5.1 GLOFA PLC network system(entire system)

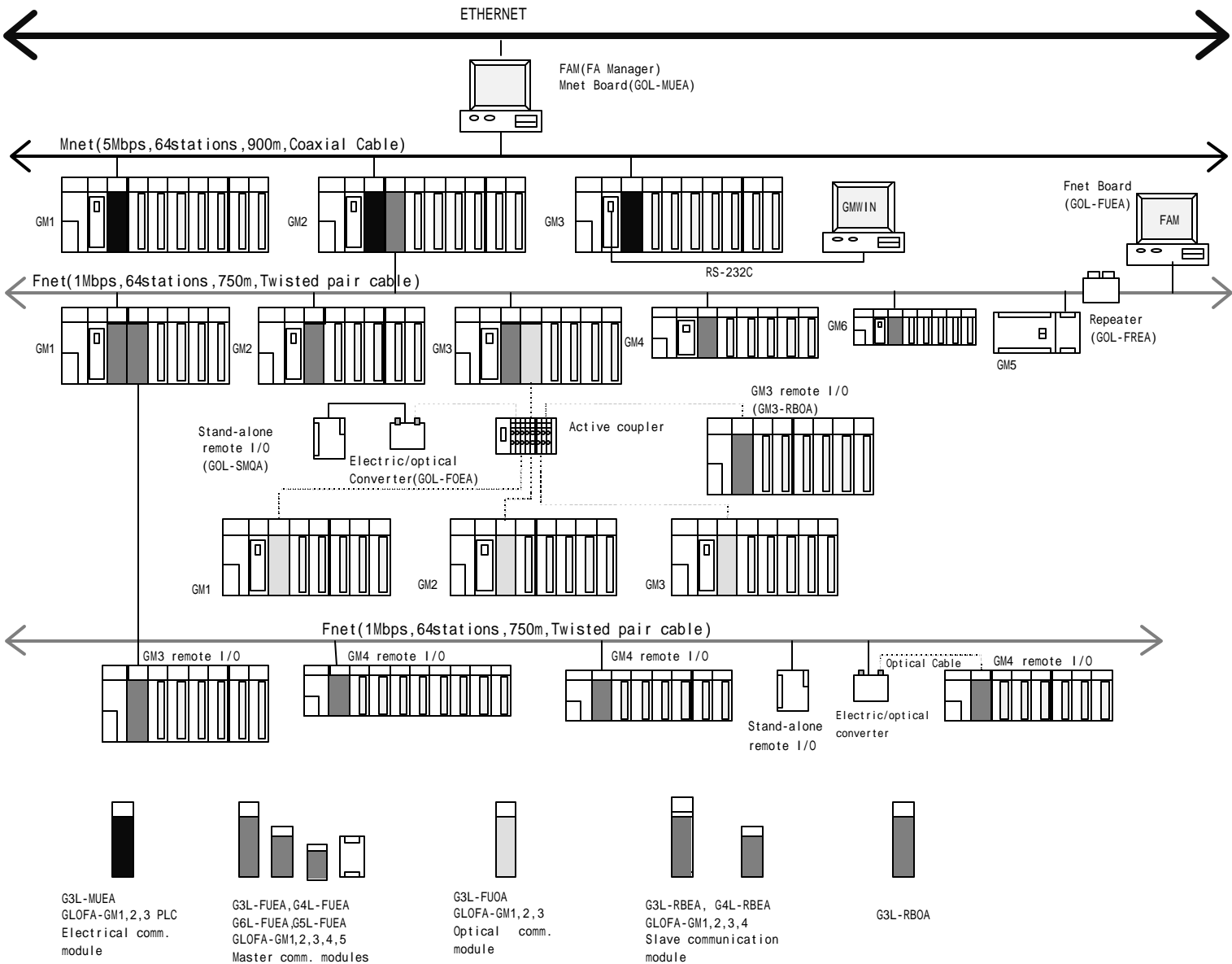

5.2 Fnet network system

5.2.1 Configuration of Fnet master system (electric network)

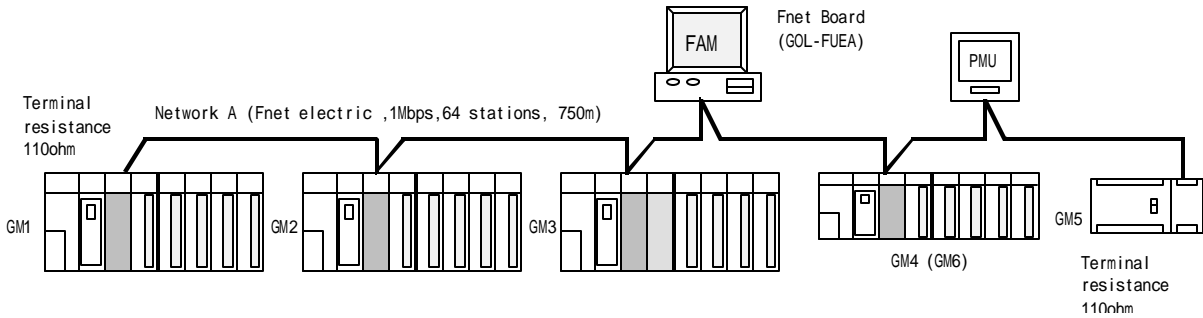

Devices for network A (Fnet electric)		
Type	Module name	Ex. of station number setting
FAM4.0	GOL-FUEA	0
GM1	G3L-FUEA	1
GM2	G3L-FUEA	2
GM3	G3L-FUEA	3
GM4 (GM6)	G4L-FUEA (G6L-FUEA)	4
GM5	G5L-FUEA	5
PMU-500	PMU-500F	6

5.2.2 Configuration of Fnet master system (optical network)

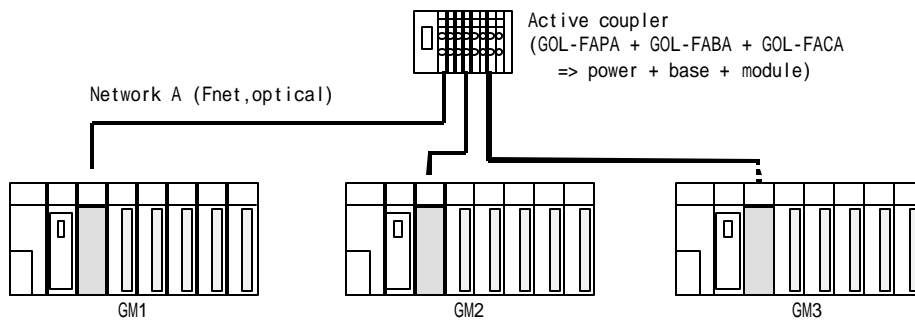

For unused slot, dummy module(GOL-FADA) is attached.

Devices for network A (Fnet optical)			
Type	Module name	Ex. of station number setting	Cable connection
GM1	G3L-FUOA	0	Transmission → Receive
GM2	G3L-FUOA	1	(Active coupler)
GM3	G3L-FUOA	2	Receive → Transmission
Active coupler	GOL-FACA/FABA/FAPA	Not available	(Active coupler)

5.2.3 Configuration of Fnet master system
(network combined with electric/optical module)

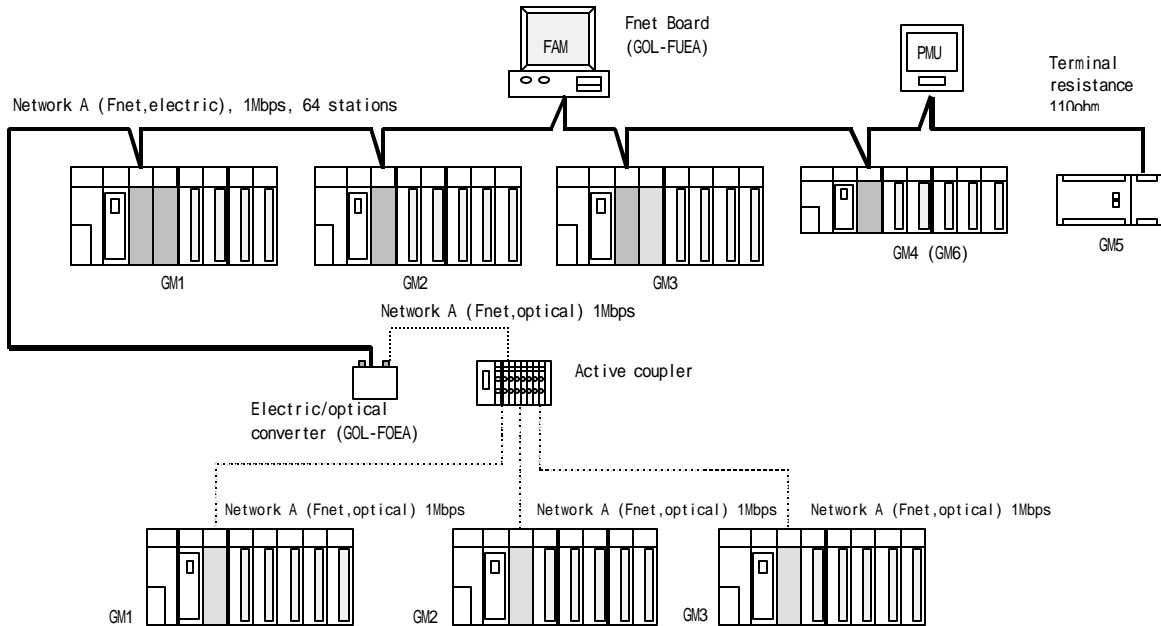

Devices for network A (Fnet)					
Electric			Optical		
Type	Module name	Ex. of station number setting	Type	Module name	Ex. of station number setting
FAM	G0L-FUEA	0	GM1	G3L-FUOA	7
GM1	G3L-FUEA	1(slot 0)	GM2	G3L-FUOA	8
GM2	G3L-FUEA	2	GM3	G3L-FUOA	9
GM3	G3L-FUEA	3	Optical/electric converter	G0L-FOEA	Not available
GM4 (GM6)	G4L-FUEA (G6L-FUEA)	4	Active coupler	G0L-FACA (Remark)	Not available
GM5	G5L-FUEA	5			
PMU-500	PMU-500F	6			

Remark

1. Separate terminal resistance is unnecessary due to terminal resistance built-in inside optical/electric converter.
2. Active coupler used in system configuration is consist of G0L-FAPA(Power), G0L-FABA(Base) and G0L-FACA(Module). Module can be mounted up to 8 in the base, and dummy module(G0L-FADA) should be attached for unused base to protect from foreign matter, dust, and the others.

5. System configuration

5.2.4 Configuration of Fnet slave system (electric network)

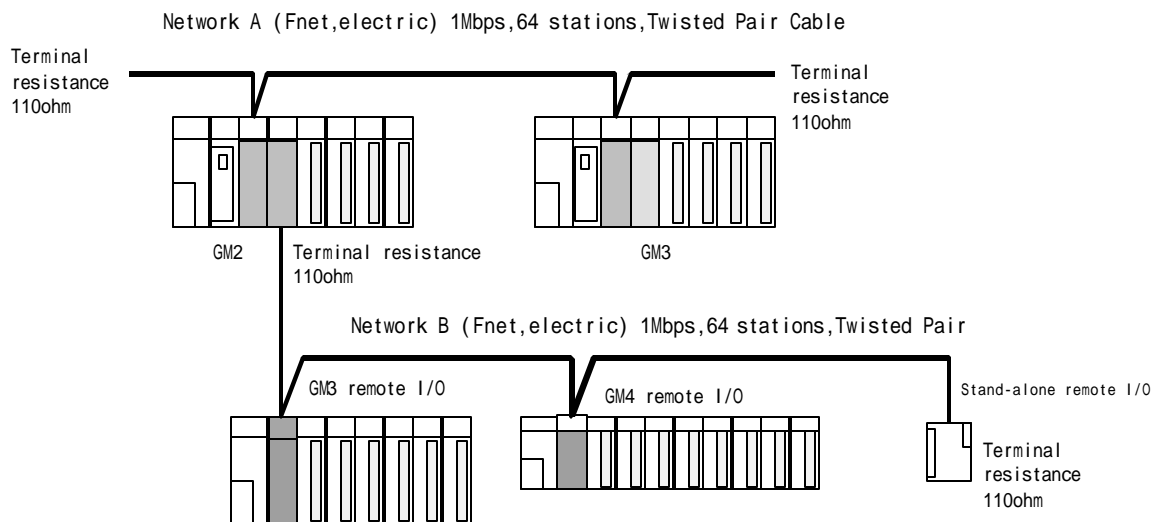

Devices for network A (Fnet electric)		
Type	Module name	Ex. of station number setting
GM2	G3L-FUEA	0(slot 0)
GM3	G3L-FUEA	2(slot 0)

Devices for network B (Fnet electric)		
Type	Module name	Ex. of station number setting
GM2	G3L-FUEA	1(slot 1)
GM3 remote I/O	G3L-RBEA	3
GM4 remote I/O	G4L-RBEA	4
Stand-alone remote output	G0L-SMQA	5

5.2.5 Configuration of Fnet slave system (optical network)

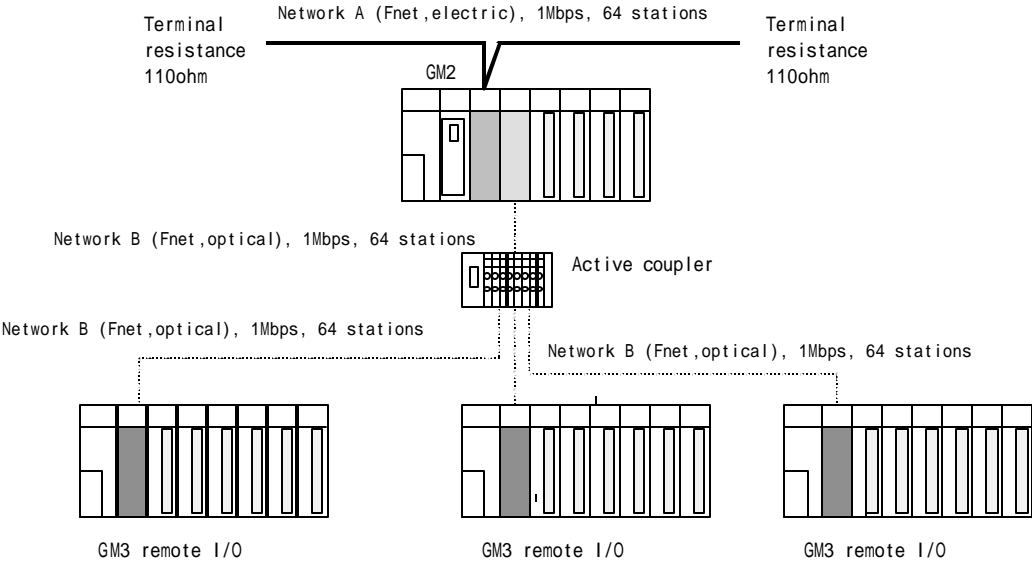

Devices for network A (Fnet ,electric)		
Type	Module name	Ex. of station number setting
GM2	G3L-FUEA	0(slot 0)

Devices for network B (Fnet ,optical)		
Type	Module name	Ex. Of station number setting
GM2	G3L-FUOA	1(slot 1)
GM3 remote I/O	G3L-RBOA	2
GM3 remote I/O	G3L-RBOA	3
GM3 remote I/O	G3L-RBOA	4
Active coupler	G0L-FACA/FABA/FAPA	Not available

5. System configuration

5.2.6 Configuration of Fnet slave system (electric/optical network)

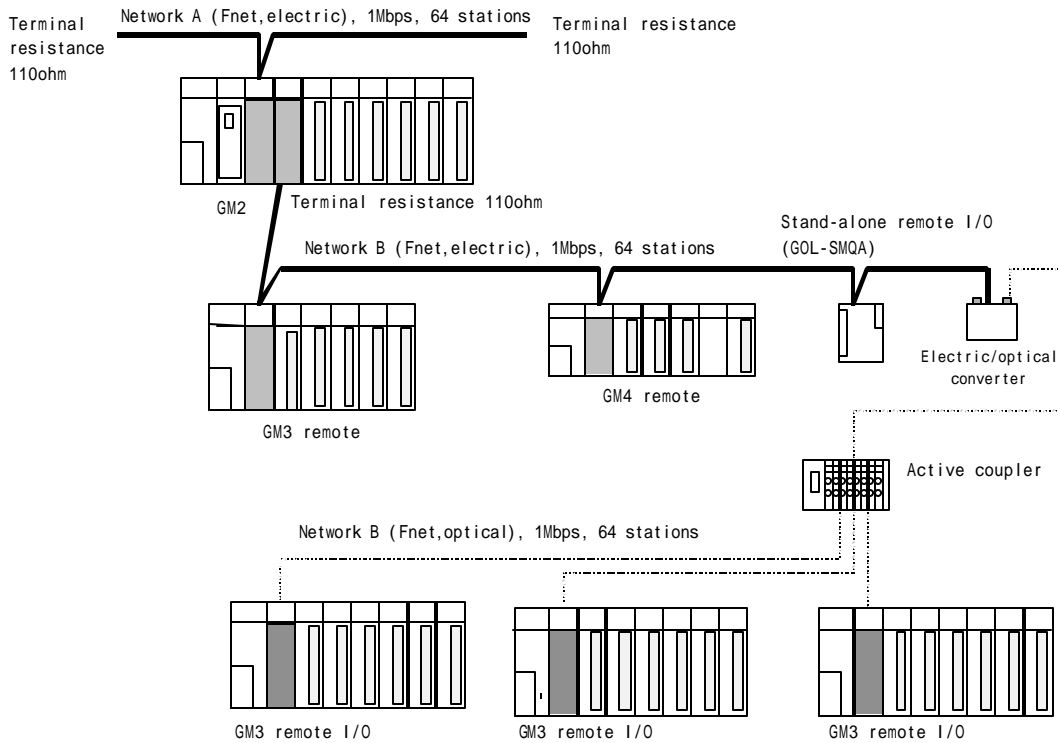

Devices for network A (Fnet electric)		
Type	Module name	Ex. of station number setting
GM2	G3L-FUEA	0(slot 0)

Devices for network B (Fnet)					
Electric			Optical		
Type	Module name	Ex. of station number setting	Type	Module name	Ex. of station number setting
GM2	G3L-FUEA	1(slot 0)	GM3 remote I/O	G3L-RBOA	5
GK3 remote I/O	G3L-RBEA	2	GM3 remote I/O	G3L-RBOA	6
GK3 remote I/O	G4L-RBEA	3	GM3 remote I/O	G3L-RBOA	7
Stand-alone remote output	GOL-SMQA	4	Electric/optical converter	GOL-FOEA	Not available
			Active coupler	GOL-FACA/ FABA/FAPA	Not available

5.2.7 Configuration of Fnet combined system (electric/optical network)

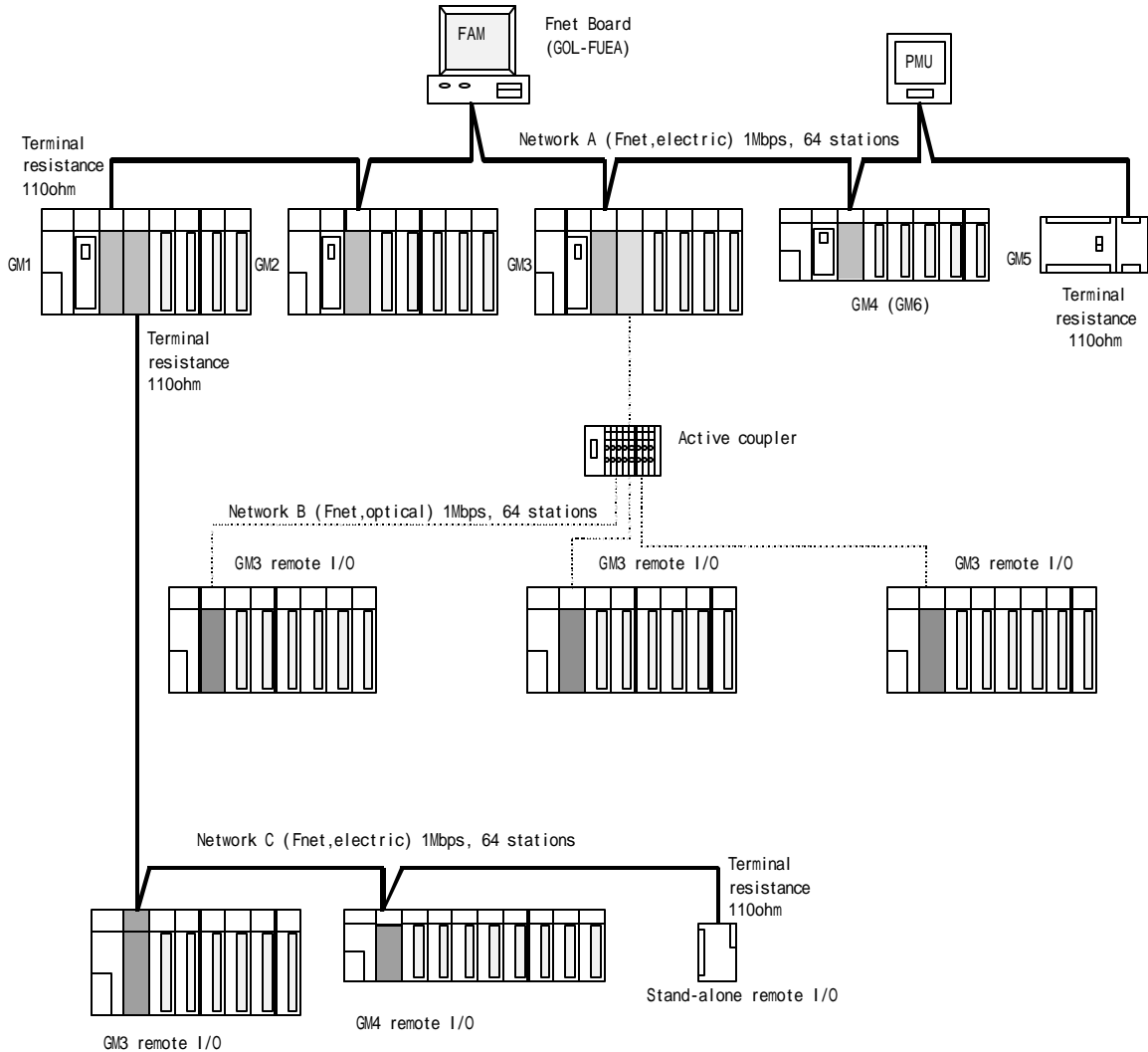

5. System configuration

Devices for network A (Fnet, electric)		
Type	Module name	Ex. of station number setting
FAM	G0L-FUEA	0
GM1	G3L-FUEA	1(slot 0)
GM2	G3L-FUEA	3
GM3	G3L-FUEA	4
GM4 (GM6)	G4L-FUEA (G6L-FUEA)	6
GM5	G5L-FUEA	7
PMU-500	PMU-500F	8

Devices for network B (Fnet, optical)		
Type	Module name	Ex. of station number setting
GM3	G0L-FUOA	5(slot 1)
GM3 remote I/O	G3L-RBOA	12
GM3 remote I/O	G3L-RBOA	13
GM3 remote I/O	G3L-RBOA	14
Active coupler	G0L-FACA/FABA/FAP A	Not available

Devices for network C (Fnet, electric)		
Type	Module name	Ex. of station number setting
GM1	G3L-FUEA	2(slot 1)
GM3 remote I/O	G3L-RBEA	9
GM4 remote I/O	G4L-RBEA	10
Stand-alone remote output	G0L-SMQA	11

5.3 Mnet network system

5.3.1 System configuration of Mnet

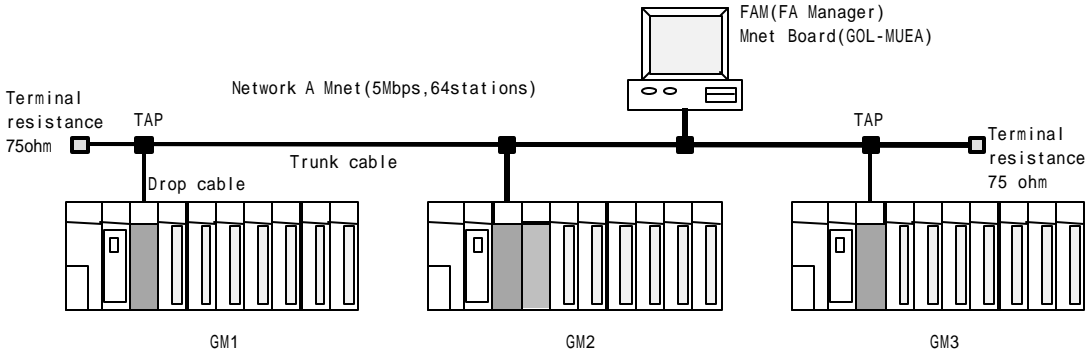

Devices for network A (Mnet)			
Type	Module name	Ex. of HS station number setting	Ex. of MAC station number
FAM	GOL-MUEA	0	16# 00E091000000
GM1	G3L-MUEA	1	16# 00E091000001
GM2	G3L-MUEA	2	16# 00E091000002
GM3	G3L-MUEA	3	16# 00E091000003

5.3.2 System configuration of Mnet (including other company's product - Ex. GOLDSEC-M series)

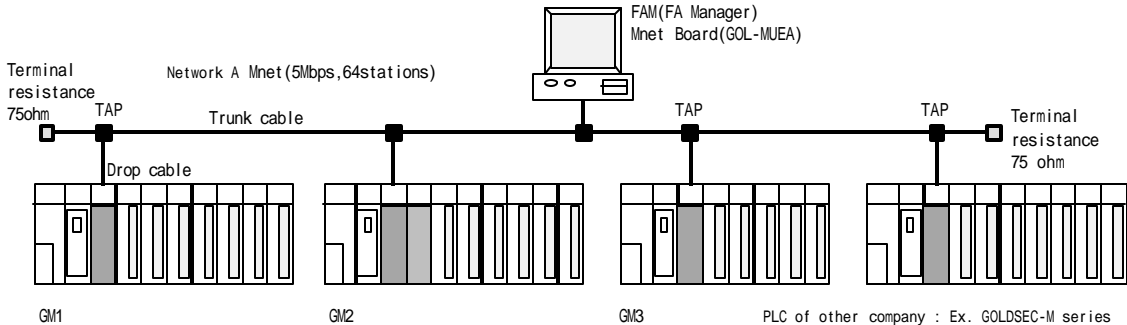

Devices for network A (Mnet)			
Type	Module name	Ex. of station number setting for high speed link communication	Ex. of MAC station number for function block communication
FAM	GOL-MUEA	0	16# 00E091000000
GM1	G3L-MUEA	1	16# 00E091000001
GM2	G3L-MUEA	2	16# 00E091000002
GM3	G3L-MUEA	3	16# 00E091000003
Other Company	MJ71M51CM1	Not available	16# 1200F2243202

5.4 Combined system of Fnet and Mnet

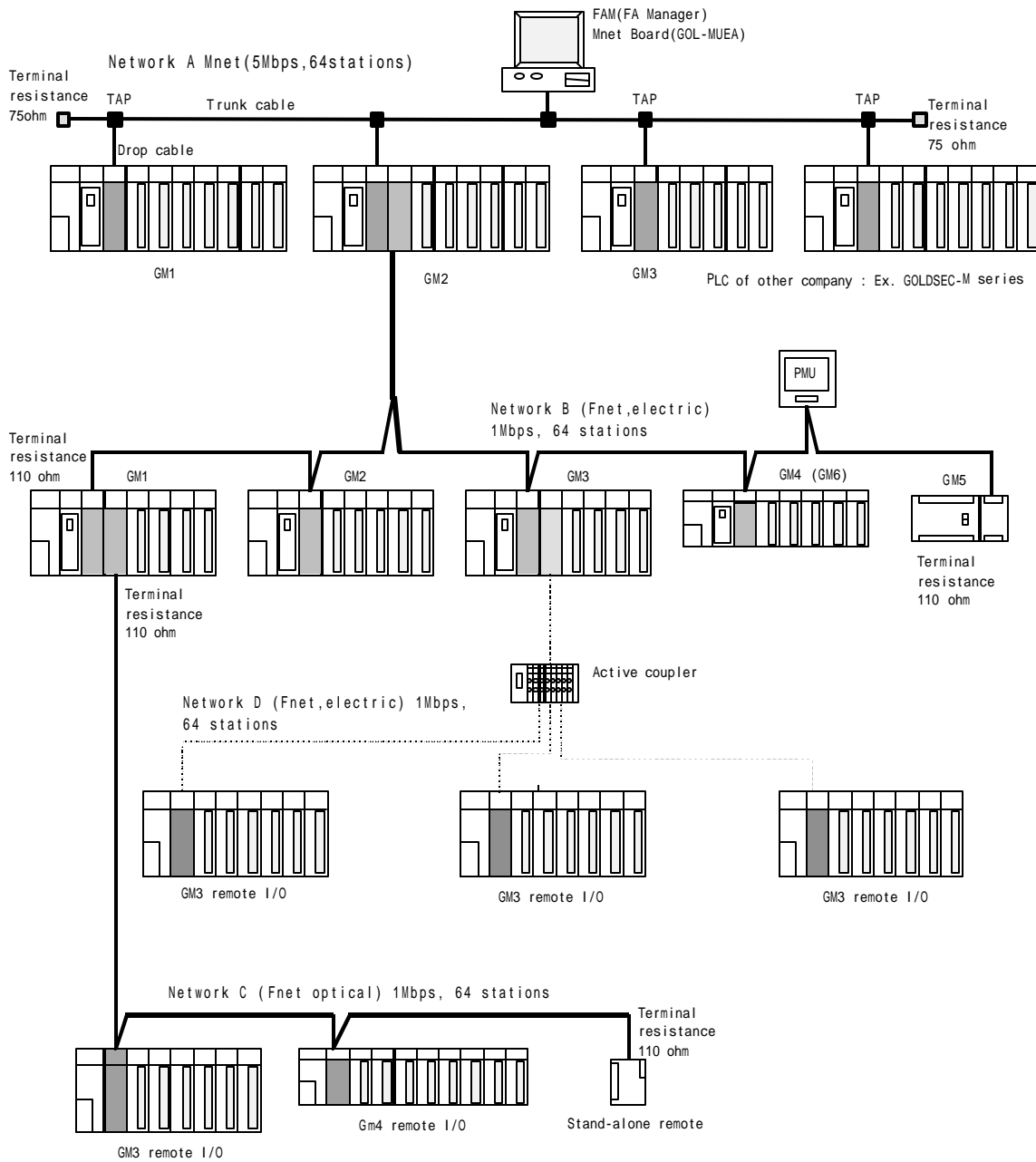

Devices for network A (Mnet)			
Type	Module name	Ex. of HS station number setting	Ex. of MAC station number
FAM4.0	G0L-MUEA	0	16# 00E091000000
GM1	G3L-MUEA	1	16# 00E091000001
GM2	G3L-MUEA	3(slot 0)	16# 00E091000002
GM3	G3L-MUEA	4	16# 00E091000003
Other company	MJ71M51CM1	5	16# 1200F2249A04

Devices for network B (Fnet, electric)		
Type	Module name	Ex. of station number setting
GM2 of network A	G3L-FUEA	2(slot 1)
GM1	G3L-FUEA	6(slot 0)
GM2	G3L-FUEA	9
GM3	G3L-FUEA	11(slot 0)
GM4 (GM6)	G4L-FUEA (G6L-FUEA)	12
GM5	G5L-FUEA	13
PMU-500	PM0-500F	14

Devices for network C (Fnet, electric)		
Type	Module name	Ex. of station number setting
GM1 of network B	G3L-FUEA	7(slot 1)
GM3 remote I/O	G3L-RBEA	15
GM4 remote I/O	G4L-RBEA	16
Stand-alone remote output	G0L-SMQA	17

Devices for network D (Fnet, optical)		
Type	Module name	Ex. of station number setting
GM3 of network B	G3L-FUOA	10(slot 1)
GM3 remote I/O	G3L-RBOA	18
GM3 remote I/O	G3L-RBOA	19
GM3 remote I/O	G3L-RBOA	20
Active coupler	G0L-FACA	Not available

Chapter 6 Communication program

6.1 Programming method

In Mnet and Fnet communication module, programming methods are divided into three :

– **High speed link**

High speed link is used when other station's data or information is exchanged in each given time and cyclically. Self or other station's data being in changing can be effectively used for operating system through cyclically referring, and the communication can be performed only through setting parameters.

For how to set, specify other station area and self area to be sent/received in parameter of GMWIN, specify data size, speed, and station number, and then perform communication.

For data size, 1(16 points)~12,800 words for Mnet, and 1~3,840 words for Fnet can be communicated, and for communication cycle, 20ms~10sec. can be set according to communicating contents. Because simple parameter setting enables communication with other station, it is easy to use, and internal data processing is also high speed, thus many data can be cyclically processed at a time.

– **Function block**

High speed link is a cyclic communication, but the communication through function block is a service that communicates when special event occurs to perform communication with other station. Function block can be used when other station has error, which is sent to another station, or special contact is entered to communicate. For how to prepare programming, using function block according to data type previously created in GMWIN program mode, specify the enable conditions, the module position in which communication module is mounted, station number, data area of self station, and other station area, and then prepare it. High speed link has unit of word(16 points) as data size, but function block has Bit, Byte, and Word, etc. as data size depending on data type to communicate with other station.

– **Simultaneous use of high speed link and function block**

For some data, high speed link and function block can be simultaneously used for program when the appropriate contents is sent if Tx/Rx of data are cyclically performed, and special event occurs.

6. Communication program

Table 6.1 Difference between *high speed link* operation and operation through *function block*

Contents	<i>High speed link</i>	<i>Function block</i>
Basic unit of Tx/Rx data	1 word(16 points)	Available according to data type Ex.) Bit, Byte, Word...
Communication cycle	20ms~10sec.	Used whenever <i>function block</i> enable condition is started up.
Module available for communication	Used between Mnet/Fnet GLOFA communication modules	Used for communication with Mnet/Fnet communication module and other company's communication module(Mini-Map only).
Specifying station number	Used by setting station number of the front of communication module in parameter	Fnet uses the station number of the front of communication module, and Mnet uses MAC address.
How to operate	Parameter setting→downloading to PLC→ <i>high speed link</i> allowed→RUN	Compiling→downloading to PLC→RUN
Control through CPU operation mode key	Used if <i>high speed link</i> is allowed even in state that CPU module is RUN, STOP, and PAUSE.	Performs operation according to key status of CPU module.

6.2 High speed link

6.2.1 Introduction

High speed link is a communication service which transmits data by setting link parameter, and a high speed data transmitting service that can exchange data through setting size of Tx/Rx(Transmission and Receive) data, period of Tx/Rx, area of Tx/Rx, and area of storage with *high speed link* parameters of GMWIN.

– **Function of *high speed link* block setting :**

- 1) If there are many Tx/Rx areas, Max. 64 blocks of each 32 of Tx/Rx can be set.
- 2) Mnet module can be set up to 200 words and Fnet can be set up to 60 words per block.
- 3) Max. link point can be used up to 12,800 words in Mnet module, and 3,840 words in Fnet module.

– **Function of Tx/Rx period setting :**

User can set the period of Tx/Rx according to each block, and the period of Tx/Rx can be set from 20ms to 10sec according to the area that quick Tx/Rx is specially needed or not.

– **Function of Tx/Rx area setting :**

Tx/Rx area can be set according to data block in GMWIN depending on user's I/O.

- **Function of *high speed link* information providing :**
High speed link information is provided to user through GMWIN user keyword, so reliable communication system can be constructed easily.

Table 6.2.1 Max. *high speed link* points according to device type

Segments		Max. number of points for communication	Max. number of points for transmission	Max. block number	Max. number of points per block	Remark
Mnet communication module	G3L-MJEA	12,800 word	6,400 word	64(0~63)	200 word	Identical value for electric/optical
	G0L-MJEA	12,800 word	6,400 word	64(0~63)	200 word	
	G3L-FJEA/FUOA	3,840 word	1,920 word	64(0~63)	60 word	
Fnet communication module	G3L-RBEA/RBOA	3,840 word	1,920 word	64(0~63)	60 word	
	G4L-FJEA	3,840 word	1,920 word	64(0~63)	60 word	
	G4L-RBEA	3,840 word	1,920 word	64(0~63)	60 word	
	G5L-FJEA	3,840 word	1,920 word	64(0~63)	60 word	
	G0L-FJEA	3,840 word	1,920 word	64(0~63)	60 word	
	G6L-FJEA	3,840 word	1,920 word	64(0~63)	60 word	

6.2.2 Tx/Rx data processing of *high speed link*

Tx/Rx data processing in *high speed link* can be described as follows(Ex. of local communication) :

Ex.) When A station sends %MW0 data, and B station receives the data %MW0 from A station and stores it to %MW100 of B station.

In *high speed link* parameter, there are each 32 block numbers for transmission and receive that is used to send/receive data, block number can be specified from 0 to 63 to use for transmission or receive. When sending data, the sending side may determine only which data is read and what number of block the data is sent to. The other station number, therefore, is unnecessary to be specified(excluding remote communication). Here, it is supposed that A station parameter has data %MW0 as area to be read, mode is transmission, and block number is optional No.5.

Because the receive side(B station) has to receive the data of the A station that is sending data %MW0 through block number No.5, the B station *high speed link* parameter must have the mode set to receive, the station number set to A, the block number 5, and storing area %MW100. As a caution, receive side must receive data through the same block number as the number sent from sending side. Sending side can use various block numbers through various station numbers to send data, so verify which data is sent and what number of block the data is sent to, and receive the data through the corresponding block number. Only if so, the required data can be received.

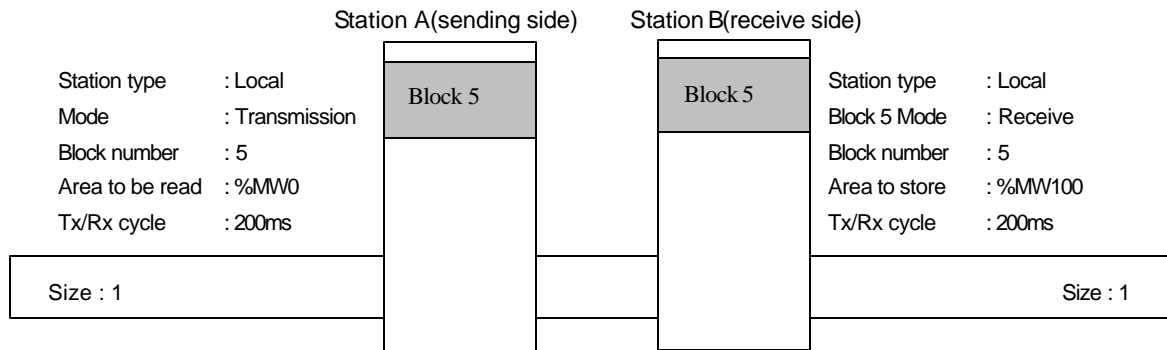

6. Communication program

* For communication parameter setting with remote module, see 6.2.4 *high speed link* parameter setting.

6.2.3 Operation procedure by high speed link

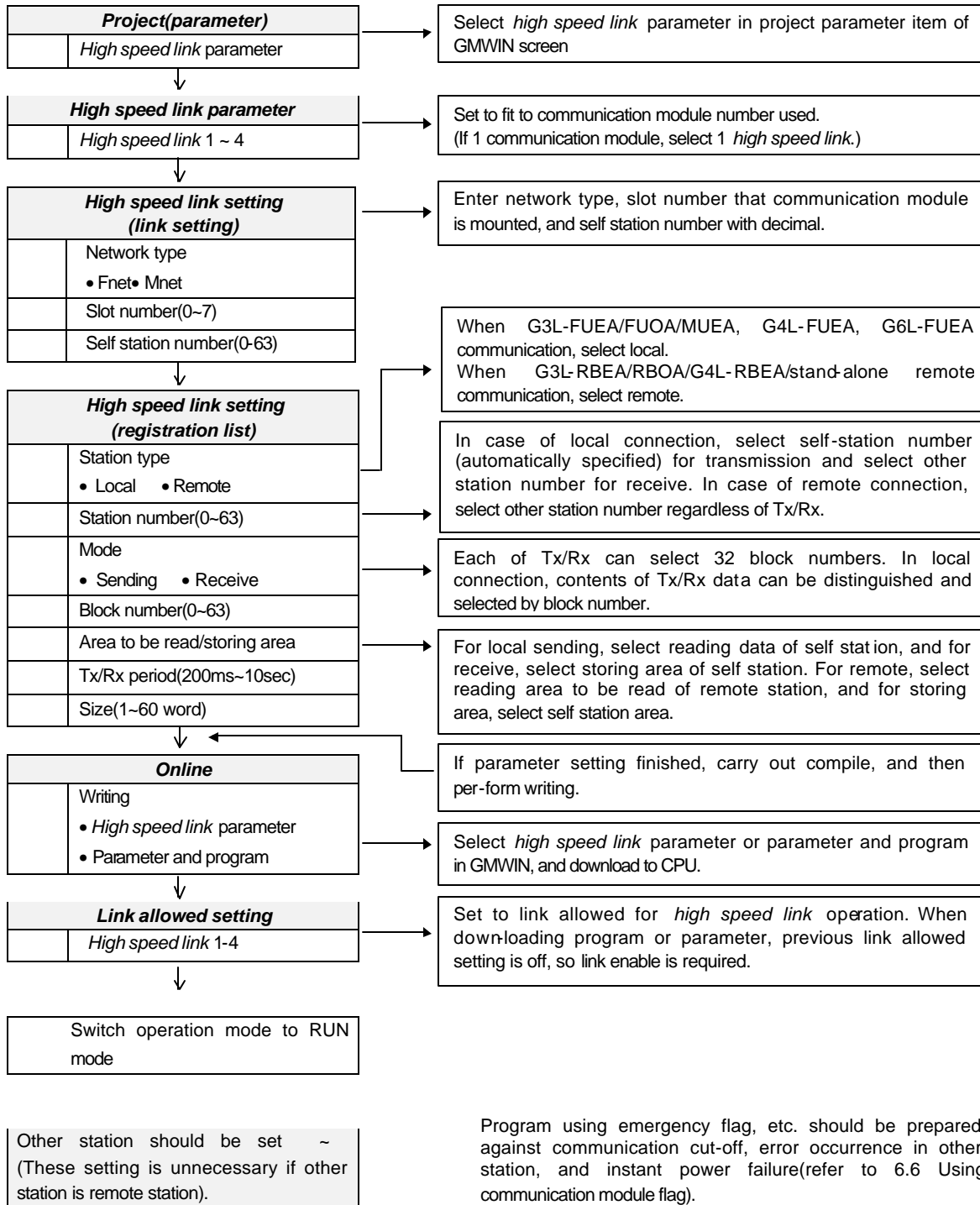

6. Communication program

6.2.4 Parameter setting of *high speed link*

To select *high speed link* parameter, select link parameter in project screen of GMWIN, and set appropriate item. Setting sequence and functions according to items are as follows:

1) Setting project of GMWIN

If *high speed link* parameter is selected in project basic screen of Fig. 6.2.4(A), the *high speed link* parameter base screen is opened as Fig. 6.2.4(B), and the appropriate item can be selected.

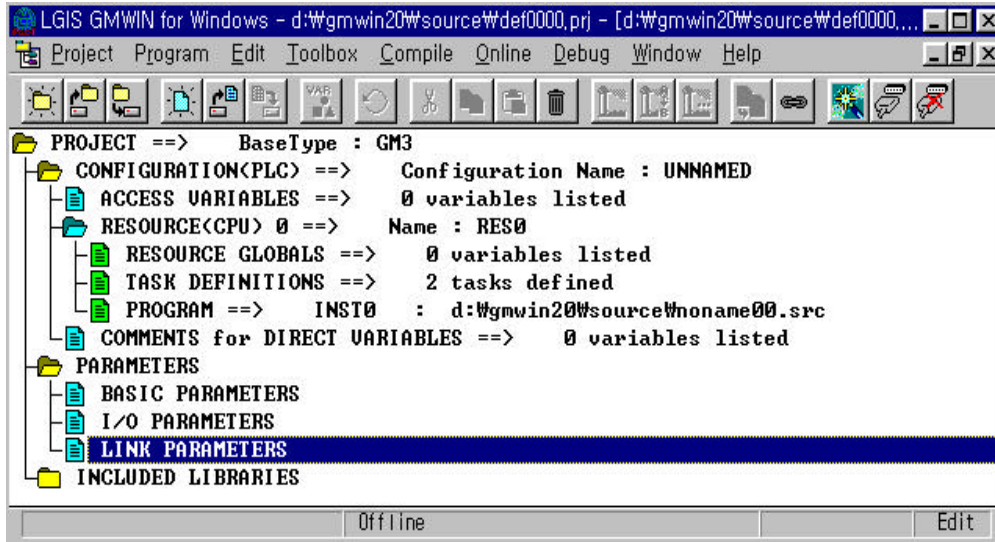

Fig. 6.2.4(A) Basic screen of GMWIN project

2) Selecting link parameter

(1) **How to set** : Fig. 6.2.4(B) is setting *high speed link* parameter in project screen.

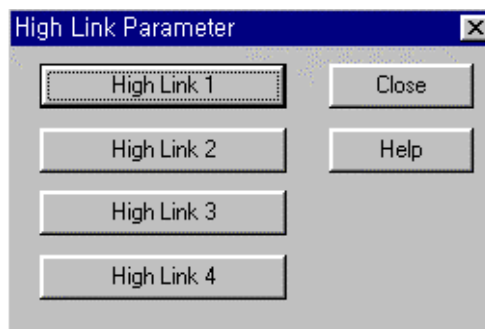

Fig. 6.2.4(B) Base screen of *high speed link* parameter

- (2) **Setting function** : *High speed link* 1~4 items of Fig. 6.2.4(B) means max. number of mountable communication modules according to PLC CPU type. GLOFA GM1/GM2/GM3 CPU are mountable up to 4 units, and GLOFA GM4 is up to 2 units.
- A) If 1 communication module is used, select *high speed link* 1.
 - B) For one communication module, only one *high speed link* parameter can be set.

Table 6.2.4(A) shows communication type and max. number of mountable units according to GLOFA CPU unit.

Table 6.2.4(A) Mounting of communication module according to CPU type

Segments	Communication module	Max. number of mounting devices	Remark
GLOFA-GM1	G3L-MUEA, G3L-FUEA, G3L-FUOA	4	Each of communication module can be combined.
GLOFA-GM2			
GLOFA-GM3			
GLOFA-GM4	G4L-FUEA	2	
GLOFA-GM5	G5L-FUEA	1	
GLOFA-GM6	G6L-FUEA	2	

3) **Link parameter setting**

If the appropriate parameter is selected in parameter setting base screen of Fig. 6.2.4(B), *high speed link* parameter setting window opens as Fig. 6.2.4(C), and the initial values are displayed as figure when first setting of parameters.

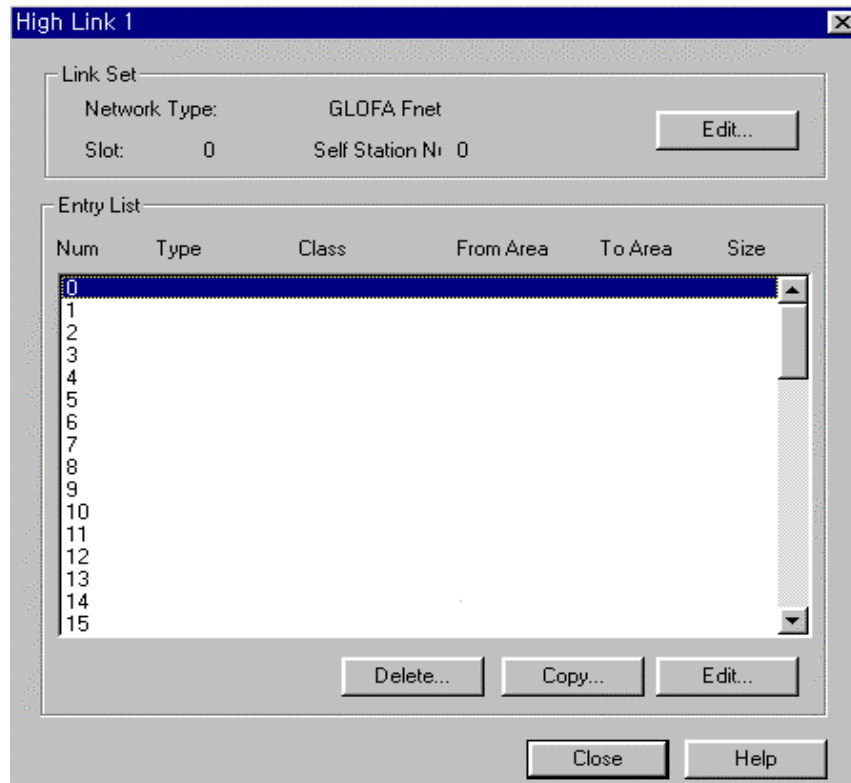

Fig. 6.2.4(C) Initial screen of parameter setting

6. Communication program

Initial screen of parameter setting is composed of ' Link setting' and ' Registration list' . How to set and functions are as follows :

(1) Link setting

Link setting is to set basic items of communication module to perform *high speed link* .

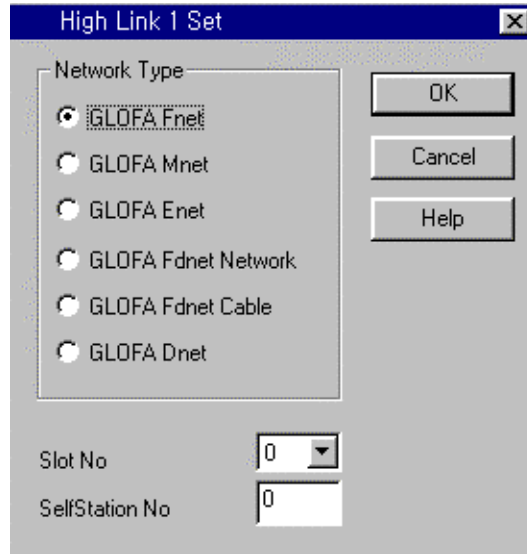

Fig. 6.2.4(D) *High speed link* setting screen

Network type : Set communication module type, and select Fnet or Mnet according to communication module type mounted.

Slot number : Set one of 0~7 for slot number that communication module to moun ted(right side of CPU module is 0 slot).

Self station : Enter self station number set in station number switch of the front of communication module. It is decimal, which can be set from 0 to 63. Self station number is unique number to distinguish communication module in the same network system, so don' t use duplicated station number.

(2) Registration list setting

Registration list setting is an area to register actual Tx/Rx information of data. Set from ' 0' that is registration number of registration list area. For this, double click on the number position to set or select the ' Modification..' button to set the appropriate contents in the modification screen of *high speed link* item as Fig. 6.2.4(E).

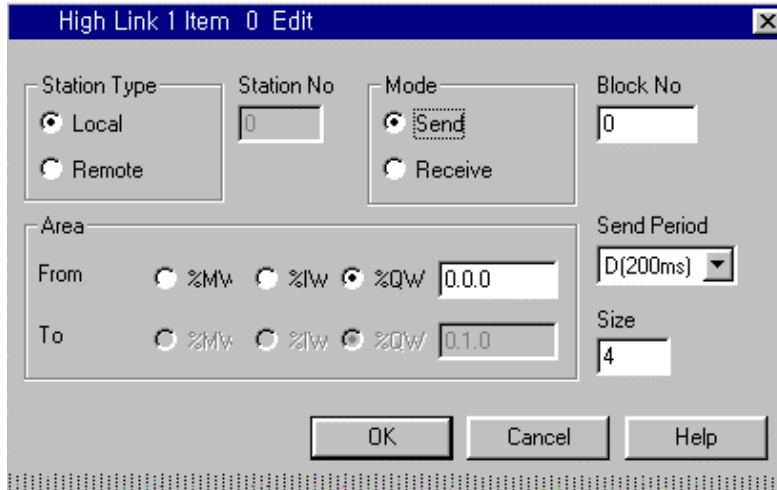

(A) Modification screen of high speed link

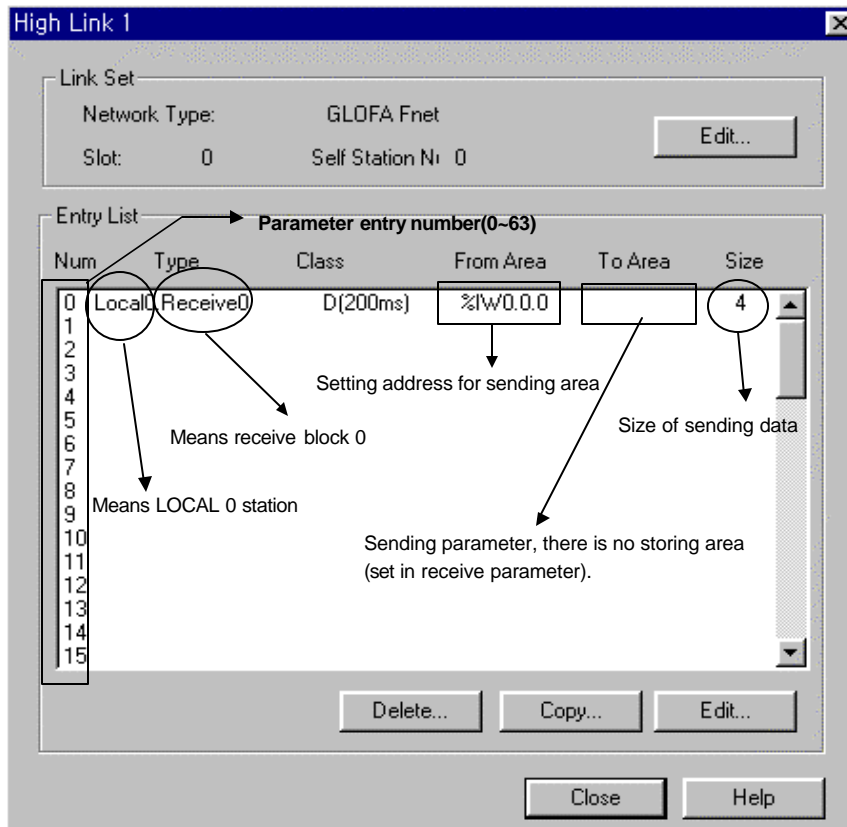

(B) Example of sending parameter setting screen

Fig. 6.2.4(E) Screen of high speed link parameter setting

6. Communication program

The functions according to each registration item of Fig. 6.2.4(E) are as follows :

- **Registration number** : This is serial number indicating the sequence registered, which can be set up to 64 from 0 to 63, and is regardless of Tx/Rxsequence.

- **Station type** : Determines the type of other station to send/receive.

Local type : G3L-FUEA/FUOA/MUEA, G4L-FUEA, G5L-FUEA, G6L-FUEA, G0L-FUEA/MUEA, monitoring interface module and the others.

Remote type : G3L-RBEA/RBOA, G4L-RBEA, Stand-alone remote, and the others.

- **Station number** : When other station to communicate is local type, set self station number for sending, and other station number for receiving. When it is remote type, set other station number for both of Tx/Rx. That is, when *high speed link* data is sent, don't specify other station number in order that data can be received by any receiving station, but when receiving, set other station number to distinguish the other station of which data is to be received. Because there is no parameter setting function in remote station itself during communication with remote station, specify remote station number during Tx/Rx.

* For sending of local type, self station number is automatically set.

Table 6.2.4(B) How to set station number

Station Type	Sending	Receiving	Station number Range
Local	Self station number	Other station number	0 ~ 63(Decimal)
Remote	Other station number	Other station number	

- **Mode** : This is an item determining whether data of appropriate block is sent/received. Therefore select sending for sending, and receiving for receiving. The number of blocks for Tx/Rx can be set up to 32. So if set to 32 or more, normal communication is impossible due to parameter error.
- **Block number** : This is set to send and receive many data of several area from one station, and distinguishes data of many blocks each other. Station number and block number configured from sending station is sent with sending data. If the receive station wants to receive this data, it must receive the appropriate block number sent from sending station. Number of blocks for Tx/Rx can be set Max. 32(0~31) for one station. It is impossible that the same block number is set for the same station number.
- **Area** : After selecting data area to send/receive, directly enter and set the address. When the area is %MW, directly enter the word area(Ex. : For 100th word area, select %MW, and enter 100). When it is %IW or %QW, after selecting %IW or %QW, directly enter(Ex.: When specifying 16 points for the 1st slot of main base, %IW 0.1.0)

- Local out** : Specifies one of %MW, %IW, %QW for area to read which data of self station is to be sent.
- Local in** : Specifies one of %MW, %IW, %QW for storing area of self station that data received from other station is to be stored.
- Remote out** : Specifies which data to read in self station(one of %MW, %IW, %QW for area to read), and which area of remote station to be sent(Only %QW of storing area is able to be specified. That is, remote sending data can be sent to remote output side only).
- Remote in** : Specifies one of %MW, %IW, %QW for which area to read in not self station but other remote station(Only %IW of area to read is able to be specified. That is, only remote input data can be read.) and which position to store it. Because memory map is different depending to CPU device type, refer to the memory map specified in the appropriate manual. Settable area according to station type that has been described as above is shown in Table 6.2.4(C).

Table 6.2.4(C) Setting area according to station type

Station type / Mode		Sending			Receive			Remark
		%IW	%QW	%MW	%IW	%QW	%MW	
Local	Area to read				x	x	x	Area means CPU memory area
	Storing area	x	x	x				
Remote	Area to read					x	x	
	Storing area	x		x				

: Settable x : Not settable

Remark

For I/O address of stand-alone remote, allocate %IW0.0.0 for input, %QW0.0.0 for output.

- **Size** : This means size of Tx/Rx data(unit is 1 word(16 points)). Module type of Fnet system can be set up to Max.60 word and Mnet system 200 word. If data size configured in receive mode is smaller than received data size, only the size of data configured in receive mode will be stored in storing area.
- **Tx/Rx period** : *High speed link* executes transmission and receive service when PLC program is finished by the parameter which user previously configured. If scan time of PLC program is short(within several ms), communication module transmits data according to program per scan, and the increase of communication quantity with this causes reduction of entire communication efficiency. To prevent this, user can set Tx/Rx period from 20ms to 10sec. If there is no setting, default of 200ms is automatically set. Tx/Rx period means transmission period if appropriate block is set to transmission, and this means data receive checking period of the appropriate block if it is set to receive. Transmission period determines data transmission period. If scan time of PLC program is longer than transmission period previously set, it will be transmitted when program scan is finished, and transmission period will be the same as scan time of PLC program(Fig.6.2.4(F)).

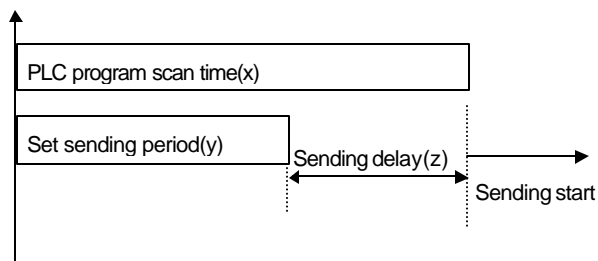

Sending delay time : $(z) = (x) - (y)$ ms

(a) Data sending delay time (PLC program scan time > Sending period)

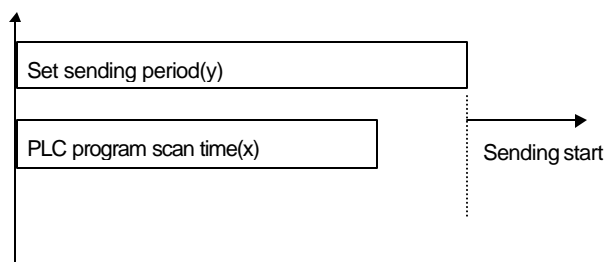

Sending delay time : $(z) = 0$ ms

(b) Data sending delay time (PLC program scan time < Sending period)

Fig. 6.2.4(F) PLC program scan and sending period

Remarks

When user sets receive period, user must set bigger value than transmission period of other station to check whether transmission is normal or not.

6.2.5 Operation of *High speed link*

If *high speed link* parameter setting is finished, perform parameter writing with PLC CPU after execution of 'make' in compile menu of GMWIN. If, thus, *high speed link* service is started, *high speed link* service starts through parameter setting. The starting sequence of *high speed link* is as follows :

1) Parameter writing

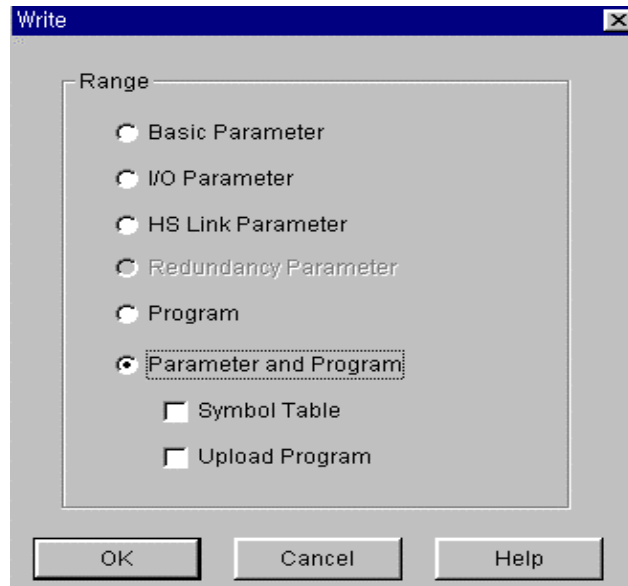

Fig. 6.2.5(A) Screen of parameter download

If *high speed link* parameter prepared by user is stored to project file of GMWIN, and the writing is selected after connection with PLC through the on-line connecting of GMWIN basic menu, the writing window in Fig. 6.2.5(A) is opened. If *high speed link* parameter or parameter and program is selected in figure, and parameter downloading is performed, the appropriate contents is downloaded.

At this time, the link enable that is *high speed link* starting information becomes off. Therefore, inevitably click on the appropriate item of *high speed link* 1~4 in link enable setting.

Remark

Before downloading parameter to CPU, carry out compile.

2) High speed link starting

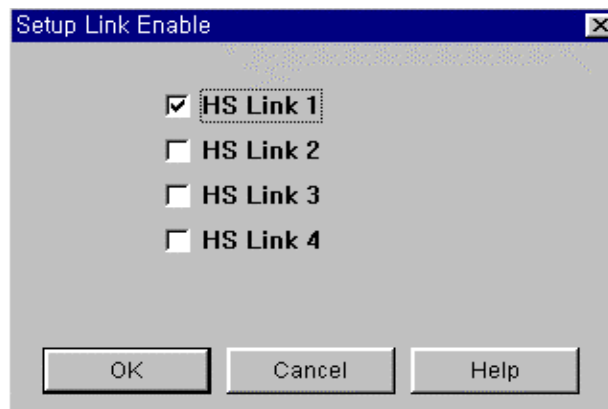

Fig. 6.2.5(B) Link enable setting

After parameter writing, *high speed link* is maintained to the stop status. Since, thus, user sets link enable, the *high speed link* is performed.

Link enable setting is possible in the stop mode of PLC only. Also, if *high speed link* enable setting is started, *high speed link* is performed regardless of PLC operation mode. Parameter and link enable information are preserved even if power is off due to battery back-up in PLC CPU.

Table 6.2.5 Relation between PLC mode and *high speed link*

Segment	Parameter downloading	Link enable setting	<i>High speed link</i> operation	Remark
PLC RUN	×	×		Only if <i>high speed link</i> enable, it is operated.
PLC STOP				
PLC PAUSE	×	×		
PLC DEBUG	×	×		

6.2.6 Relation between *high speed link* and CPU mode switch

Once *high speed link* enable setting is started, the *high speed link* performs the *high speed link* regardless of PLC operation mode. Therefore, output data can not be controlled by operation of other station or self station mode switch if data is sent from parameter Tx/Rx area to direct output(%Q area) through the *high speed link*. To control it, data from other station must be received into %M area, and this data must become output. Thus controlling by mode switch becomes possible.

6. Communication program

6.2.7 Communication status information of *high speed link*

1) *High speed link* information function

To confirm the reliability of data read from other station, it provides user with the information which can check the state of *high speed link* service. Namely, there are entire high speed link information of RUN_LINK and LINK_TROUBLE, and individual information of HS_STATE, TRX_MODE, DEVICE_MODE, and ERROR which shows communication state according to 64 registered items of in parameter. User can use the above information for emergency or maintenance and repair combining with *high speed link* Tx/Rx data in type of key word in preparing program.

Table 6.2.7 *High speed link* information

Segment	RUN_LINK	LINK-TROUBLE	Tx/Rx status (TRX_MODE)	Operation mode (DEV_MODE)	Error (DEV_ERROR)	<i>High speed link</i> status (HS_STATE)
Type of information	Entire information	Entire information	Individual information	Individual information	Individual information	Individual information
KEYWORD (=number of <i>high speed link</i> , 1~4)	_HS RLINK	_HS LTRBL	_HS TRX[n] (n=individual parameter No. 0~63)	_HS MOD[n] (n= individual parameter No. 0~63)	_HS ERR[n] (n= individual parameter No. 0~63)	_HS STATE[n] (n= individual parameter No. 0~63)
Data type	BIT	BIT	BIT-ARRAY	BIT-ARRAY	BIT-ARRAY	BIT-ARRAY
Monitoring	Possible	Possible	Possible	Possible	Possible	Possible
Program use	Possible	Possible	Possible	Possible	Possible	Possible

(1) RUN_LINK(_HS RLINK)

This is entire information indicates whether *high speed link* is made using parameter configured by user. Once it becomes 'On', the contact is maintained to 'On' until link enable becomes 'Off'. When it is under the following conditions, it becomes 'On'.

When link enable becomes 'On'.

When all of parameter registration list settings are normal.

When all data corresponding to parameter registration list are sent/received in accordance with the set period.

When status of all other stations set in parameter are RUN, and at the same time there is no error.

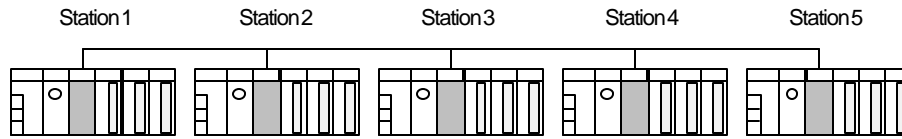

(a) Configuration of *high speed link* system

Station 1	Station 2	Station 3	Station 4	Station 5
Transmission: 2 words Receive : 2 words (Station No. ' 2') Receive : 2 words (Station No. ' 3')	Transmission : 2 words Receive : 2 words (Station No. ' 1') Receive : 2 words (Station No. ' 4')	Transmission : 2 words Receive : 2 words (Station No. ' 1') Receive : 2 words (Station No. ' 5')	Transmission : 2 words	Transmission : 2 words

(b) Example of *high speed link* parameter setting

Fig. 6.2.7(A) Conditions of RUN_LINK On

Fig. 6.2.7(A) shows configuration of *high speed link* system to explain the conditions that RUN_LINK set to 'On'. It is supposed that 5 communication modules are connected with network as (a) of Fig. 6.2.7(A) and *high speed link* is made with the parameters set as Figure (b). In this system, the conditions that RUN_LINK of station 1 becomes 'On' are as follows :

- Link-enable of self station(station 1) is 'On'.
- State of self station(station 1) is RUN.
- Self station(station 1) has no error.
- Data configured with transmission parameter of self station(station 1) are transmitted in accordance with transmission period.
- Receive data of station 2 or 3 are received in accordance with receive period.
- Operation mode of other station(station 2 or 3) which receives from self station(station 1) is RUN mode and has no error, and transmits and receives in accordance with Tx/Rx period.
- When operation mode of another station(4, 5 station) that is set in other station(2, 3 station) is not RUN mode and not error state, and communication is made according to TR period.

If above all of 7 items are met, RUN_LINK of station 1 is set to 'On'. If many PLC performs interlock operation through *high speed link*, user can verify reliability using RUN_LINK contact. Once RUN_LINK contact is set to 'On', it maintains the state until link-enable is set to 'Off'. User, therefore, must also use LINK_TROUBLE information contact in the following item for abnormal state monitoring such as communication error.

(2) **LINK_TROUBLE(_HS LTRBL)**

If RUN_LINK is 'On' and the case that doesn't comply with the condition of RUN_LINK to be 'On' is occurred, LINK_TROUBLE is set to 'On', and if the condition is removed it is set to 'Off'.

6. Communication program

(3) **State of Tx/Rx(_TRX STATE[0~63])**

If each parameter operation for individual parameter registration No.(0~63) is performed exactly in accordance with Tx/Rx period, the appropriate bit is set to 'On', but if it is not performed in accordance with Tx/Rx period, the appropriate bit is set to 'Off'.

(4) **Operation mode(_HS MODE[0~63])**

This mode shows parameter operation mode information according to individual parameter registration No.(0~63). If the station configured in registration item is RUN mode, the appropriate bit is set to 'On'. In STOP/PAUSE/DEBUG mode, the appropriate bit is set to 'Off'.

(5) **Error(_HS ERR[0~63])**

This mode shows parameter error information according to individual parameter registration No.(0~63). Error shows overall situation that PLC can't operate user program normally. If this is set to 'Off', it means other station's PLC performs normal operation, and if this is set to 'On', it means other station's PLC is under abnormal operation.

(6) **State of high speed link(_HS STATE[0~63])**

This shows overall information for registered list by overall of individual item information. Namely, This is set to 'On' if Tx/Rx state of appropriate list is normal, operation mode is RUN, and has no error. This is set to 'Off' if Tx/Rx state of appropriate list doesn't comply with above items.

Remark

Among keyword contents used in items of (1)~(6)

: : Shows number(1,2,3,4) of *high speed link* used in parameter setting(If communication module mounted is 1 unit, 1 is normally used).

[0~63] : Shows registration number of individual parameter in left side of Fig. 6.2.4(E)(This can be used to monitor communication state according to each parameter of 0~63)..

2) **Information monitor of high speed link**

The current *high speed link* state can be monitored by using monitor function after connection of GMWIN on-line. How to monitor is divided into two : the one is to select variable monitor in monitor menu ; the other is to select link parameter monitor.

(1) **Variable monitor**

Variable monitor is a function that can monitor by selecting only the required item through flag monitor function of GMWIN. The sequence is as follows :

Select variable monitor in monitor item of on-line.

Select Flag in variable registration screen of Fig. 6.2.7(B).

Select and register the *high speed link* information flag by one and one that user wants to directly monitor in variable and flag list screen (Because _HSxSTATE[n], _HSxERR[n], _HSxMOD[n], _HSxTRX[n] are array flag, enter the registration No. in parameter that user wants to directly monitor).

'x' means *high speed link* No., which has a range of 1~4 in GM1/GM2/GM3 PLC CPU, a range of 1~2 in GM4 CPU, and only 1 available in GM5 CPU. [n] is the number(0~63) of individual parameter.

If the closing selected after variable registration in Fig. 6.2.7(B), monitor screen of Fig. 6.2.7(C) is displayed, and monitoring is started.

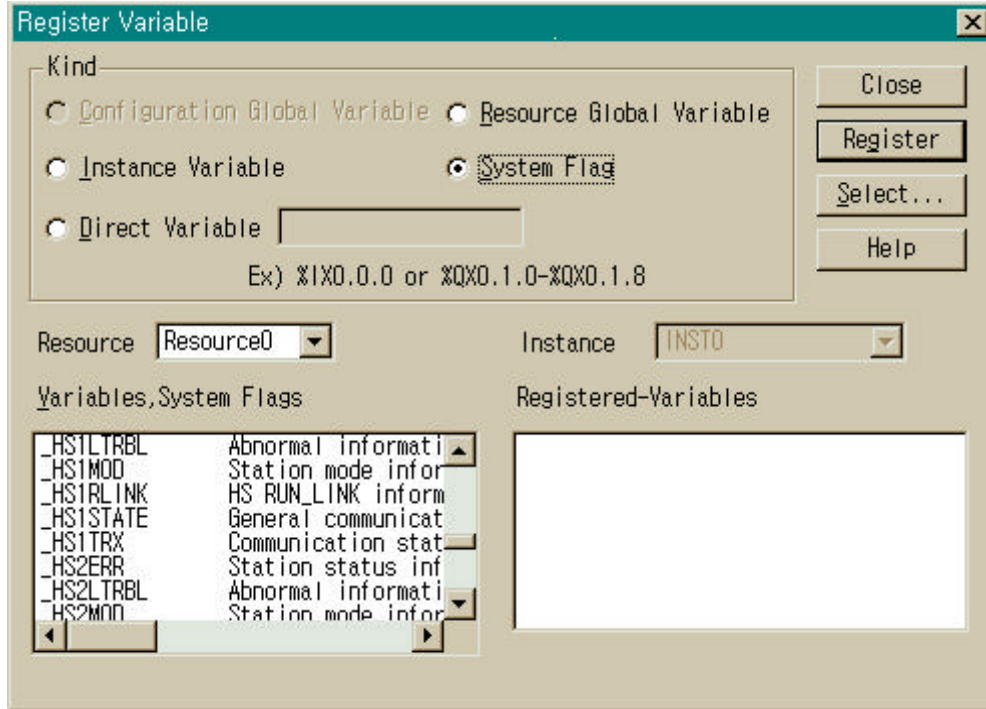

Fig. 6.2.7(B) Variable registration screen of *high speed link* information

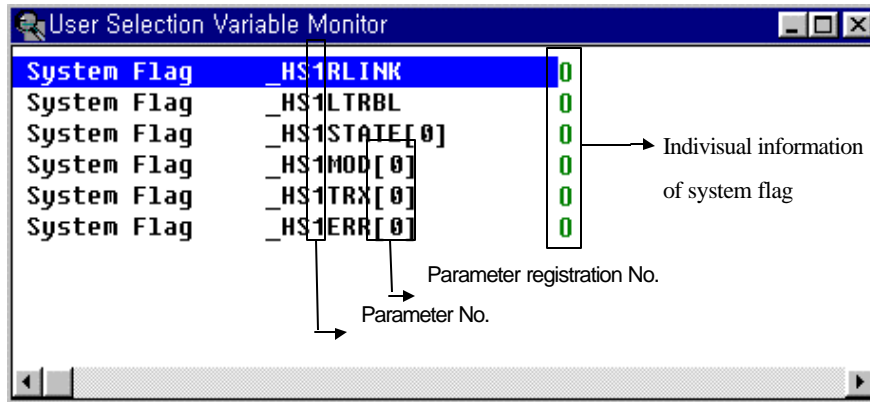

Fig. 6.2.7.(C) Monitor screen of *high speed link* information(variable registration)

(2) **Link parameter monitor**

This is a function that can directly monitor communication state in the parameter item set. If link parameter item is selected in monitor menu of GMWIN on-line connection, Selecting screen of link parameter as Fig. 6.2.7(D) is displayed.

6. Communication program

If user selects a required item of parameter numbers, and clicks on the OK button, monitor screen of *high speed link* parameter in Fig. 6.2.7(E) is opened, and the registration list set is monitored and displayed in screen.

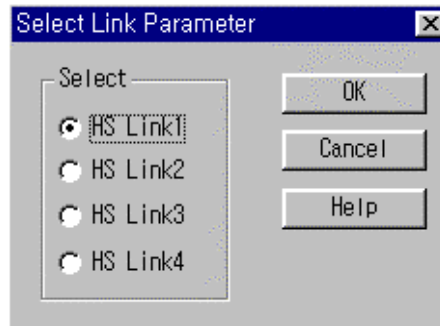

Fig. 6.2.7(D) Selecting screen of link parameter

For link parameter monitor of Fig. 6.2.7(E), the entire information on RUN-LINK and LINK-TROUBLE is displayed in upper part of screen, and the individual information on mode(operation mode), communication mode(Tx/Rx state), and error is displayed in each parameter item set.

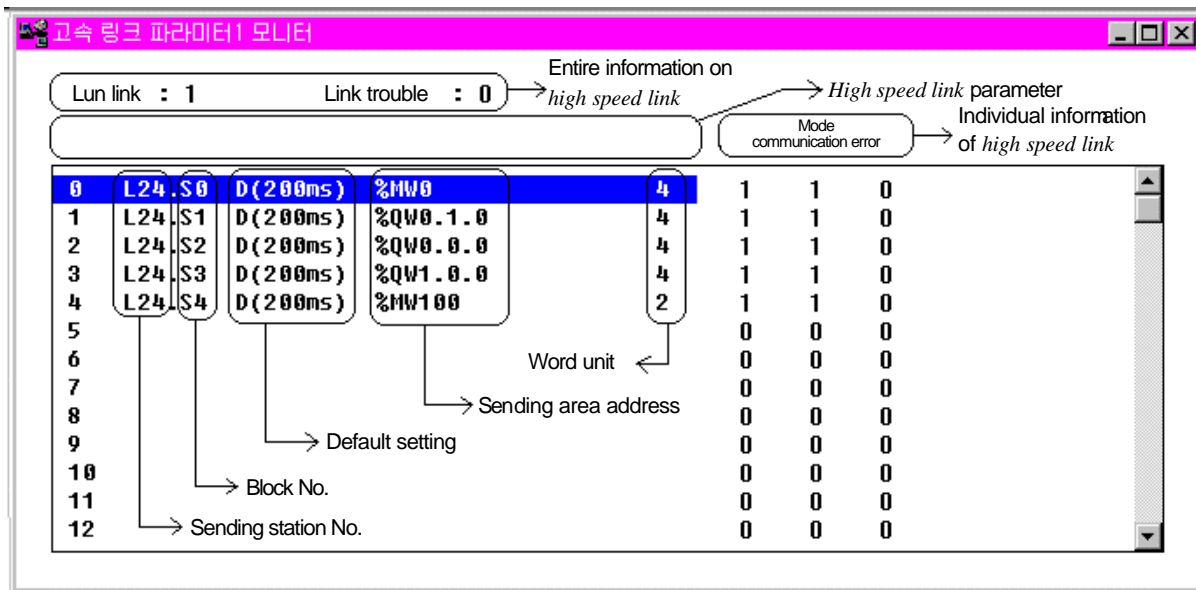

Fig. 6.2.7(E) Monitor screen of *high speed link* parameter(Example)

The values monitored in Fig. 6.2.7(E) mean the following :

RUN-LINK:1: Indicates the integrated information that the current state(24 station) of self station is link enable 'On' and RUN state, and the communication of No.0,1,2,3,4 set by parameter has not any error and is in normal operation in accordance with the sending period.
If even one of these conditions is not met, RUN-LINK becomes '0'.

LINK-TROUBLE:0: Means that there is no link trouble in No.0~4, or RUN-LINK is out of conditions of 'On', it becomes '1'.

Mode 1: Indicates that the station(24 stations) set by the appropriate parameter registration number is RUN mode. If mode is STOP/PAUSE/DEBUG, it becomes '0'.

Communication 1: Indicates that normal communication with the contents set by the appropriate parameter registration number is performed.

Error 0: Indicates that communication with the contents set by the appropriate parameter registration number has not any error.

6.2.8 Speed calculation of *high speed link*

1) Introduction

Transmission speed of *high speed link* data be determined by many factors. Sending data from one communication station to the other station is performed in the following path.

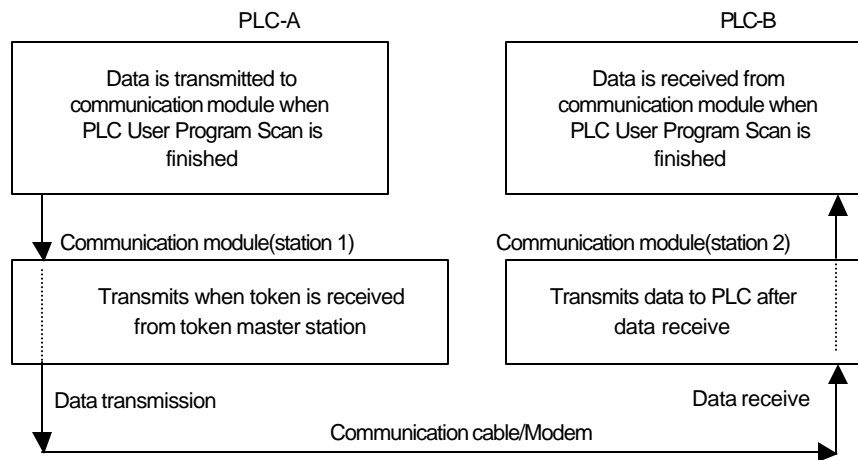

Fig. 6.2.8 Data sending path through communication module

Three paths should be passed to transmit data to other station through communication as Fig. 6.2.8(A), and transmission time is determined by the total time taken according to each path. Main path of data transmission and the elements that affect the taken time according to each path are as Table 6.2.8.

Table 6.2.8 Data transmission path and time elements

Path		Time affecting elements
PLC CPU(A)	Communication module(station 1)	Scan time of PLC-A program
Communication module(station 1)	Communication module(station 2)	Scan time of communication + Scan time of communication O/S
Communication Module(station 2)	PLC CPU(B)	Scan time of PLC-B program

In data transmission between PLC CPU and communication module, because it is transmitted on the time when PLC user program is finished, scan time of PLC user program becomes main element of data transmission. If user selects PLC information in On-line menu of GMWIN, user can know Max./Min./current scan time of program through program scan time.

6. Communication program

Communication module should obtain communication right, namely, token to transmit data of itself, and this is determined according to token rotation time. After that, Tx/Rx of data is performed, so this time also be included in communication delay time

Fig. 6.2.8(B) shows transmission time according to the scan time of PLC program and communication scan time.

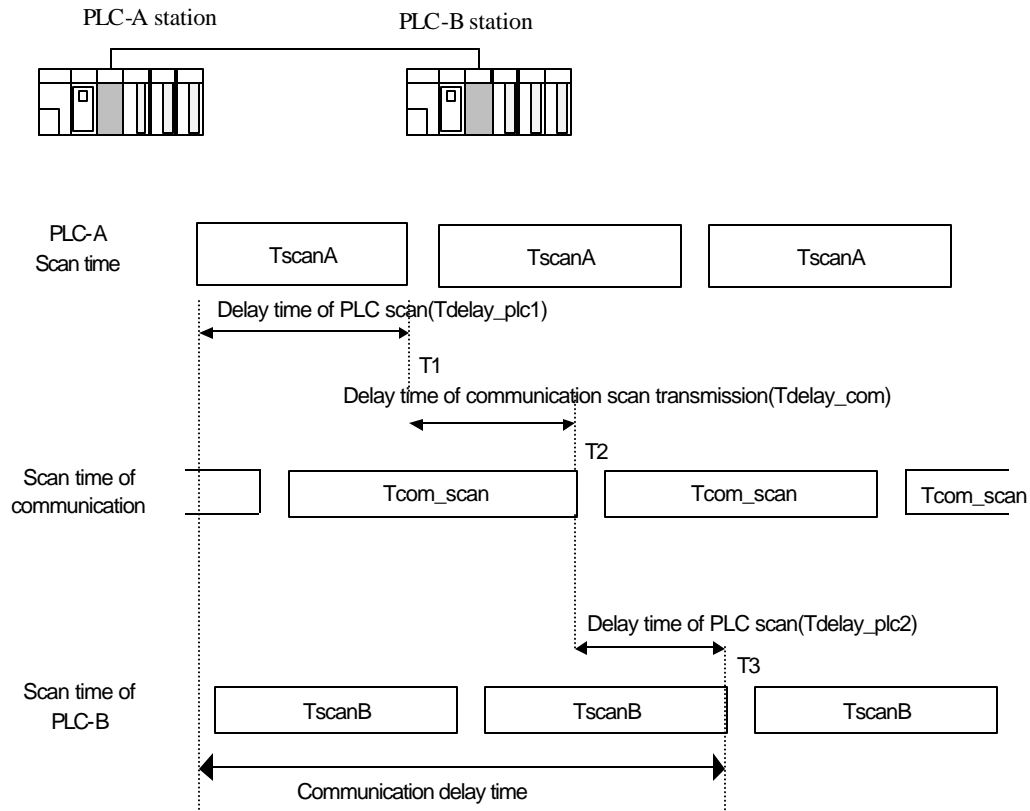

Fig. 6.2.8(B) Relation between PLC and communication in scan time

In Fig. 6.2.8(B), the total communication delay time is $T_1+T_2+T_3$. Communication delay time is determined by the entire number of communication stations, the program size, the O/S scan time of communication module, and the others. But these variables are difficult to calculate. Therefore, the following simple example of communication speed in *high speed link* can be presented.

2) How to calculate speed of *high speed link*

Speed of *high speed link* in fig. 6.2.8(B) supposes that it is to calculate the Max. time required to be taken when data of one block is transmitted from PLC-A to PLC-B. Communication delay time that is depending on entire communication station number and program size can be calculated with two different cases : the one is complicated system that number of stations is 10 or more and number of data to be sent exceeds 512 byte ; the other is simple system of the less. The calculations are as follows :

(1) **Simple system**

In a simple system that the number of entire communication stations is less than 10 and the size of transmission data is 512 byte or less, the speed of *high speed link* can be calculated with a simple equation as follows :

$$St = P_scanA + C_scan + P_scanB..... [Equation 6.2.8(A)]$$

- St = Max. transmission time of *high speed link*
- P_scanA = Max. program scan time of PLC A
- C_scan = Max. communication module scan time
- P_scanB = Max. program scan time of PLC B

And each item can be calculated as followings :

$$C_scan = Th \times Sn..... [Equation 6.2.8(B)]$$

- Th = Token hold time : token using time per 1 station
- Sn = Total station number : Entire communication station number

Token hold time(Th)=  Fnet : 8ms
Mnet : 2.3ms

(2) **Complicated system**

In a complicated system that the number of entire communication stations is 10 or more and the size of transmission data is 512 byte or more, the speed of *high speed link* is calculated as the following equation.

$$St = Et \times To \times Ntx + Mf..... [Equation 6.2.8(C)]$$

- Et = Effective Tx ratio
- To = Octet time(transmission time of one byte)
- Ntx = Total Tx number
- Mf = Margin factor,

and each item is determined as follows :

$$Et = St \times Nf..... [Equation 6.2.8(D)]$$

- St = total number of communication stations
- Nf = Network factor, constant value according to characteristics of communication system
- Fnet system : 1.5, Mnet system : 1.2

- To = Octet time, time taken in transmitting one byte data as a serial data, and this is determined as follows :
 - Fnet : 8 μs,
 - Mnet : 1.6 μs

6. Communication program

Ntx = Number of total receive data including number of variable services, and this is determined as follows :

- Fnet : Sum of transmission byte number of *high speed link* + Number of variable F/B
× 256
- Mnet : Sum of transmission byte number of *high speed link* + Number of variable F/B
× 1,024

Mf = Margin factor for elements which can't be expressed with above expressions, like O/S scan time of communication module, etc., and this is determined as follows :

- Fnet : 16ms,
- Mnet : 50ms

6.2.9 Ex. 1 : *High speed link* among PLCs of Fnet**Ex. 1**

In GM3/GM4 base, slot 0 has communication module, slot 1 output 32-point, and slot 2 input 32-point module mounted. 32-point data(%IW0.2.0) of GM3 is sent to %MWO of GM4, and 32-point data(%IW0.2.0) of GM4 is sent to %MW100 of GM3. These are supposed.



To perform the program of Ex.1, firstly configure I/O configuration table as Table 6.2.9, and prepare *high speed link* parameter in each appropriate CPU module.

Table 6.2.9 I/O configuration and Tx/Rx flow

Tx/Rx structure	I/O configuration (All stations same)	Area to read	Storing area	Block No.	Size (word)
GM3 (station 0) TX : →GM4 RX : ←GM4	Slot 0 : communication module	%IW0.2.0	--	0	2
		--	%MW100	1	2
GM4 (station 1) TX : →GM3 RX : ←GM3	Slot 1 : OUT 32 point	%IW0.2.0	--	1	2
	Slot 2 : IN 32 point	--	%MWO	0	2

Working procedure(GM3 and GM4 are the same)

- 1) Allocate station No. and connect communication cable.
- 2) Prepare user program(for each station).
- 3) Prepare data Tx/Rx map of the type as Table 6.2.9.
- 4) Set parameter in *high speed link* parameter setting item of GMWIN.
- 5) Perform compile and make in compile menu.
- 6) Carry out program and parameter writing in on-line menu.
- 7) Select link enable setting in on-line menu, and set the *high speed link* enable that fits to set number.
- 8) Change mode into RUN in on-line menu.
- 9) Start monitoring in on-line menu, and verify whether RUN link has become On without error under *high speed link* monitor.
- 10) When error occurs, perform from 1) again.

Remark

When data sent via block No. '0' from station 0 is used in station 1, the receive parameter block No. must be set to 0. That is, when data sent from other station is received, the block No. used in other station must also be equally used in receiving side.

6. Communication program

(1) Transmission parameter setting of station 0(GM3)

The screenshot shows the 'High Link 1' dialog box with the following settings:

- Link Set:** Network Type: GLOFA Fnet, Slot: 0, Self Station No: 0. An 'Edit...' button is present.
- High Link 1 Item 0 Edit:**
 - Station Type:** Local (selected), Remote.
 - Station No:** 0.
 - Mode:** Send (selected), Receive.
 - Block No:** 0.
 - Area:** From: %Mv, %Iw (selected), %QW, 0.2.0; To: %Mv, %Iw, %QW.
 - Send Period:** D(200ms).
 - Size:** 2.
- Buttons:** OK, Cancel, Help, Delete..., Copy..., Edit..., Close, Help.

(2) Receive parameter setting of station 0(GM3)

The screenshot shows the 'High Link 1' dialog box with the following settings:

- Link Set:** Network Type: GLOFA Fnet, Slot: 0, Self Station No: 0. An 'Edit...' button is present.
- High Link 1 Item 0 Edit:**
 - Station Type:** Local (selected), Remote.
 - Station No:** 1.
 - Mode:** Send, Receive (selected).
 - Block No:** 0.
 - Area:** From: %Mv, %Iw, %QW, 0.2.0; To: %Mv (selected), %Iw, %QW, 100.
 - Send Period:** D(200ms).
 - Size:** 2.
- Buttons:** OK, Cancel, Help, Delete..., Copy..., Edit..., Close, Help.

(3) Transmission parameter setting of station 1(GM4)

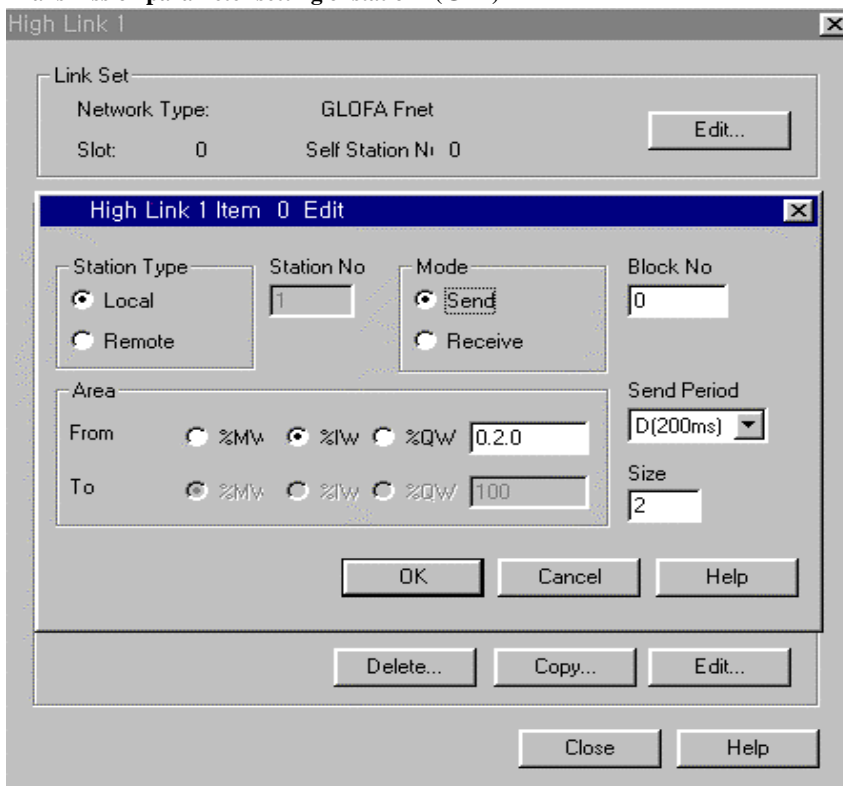

(4) Receive parameter setting of station 1(GM4)

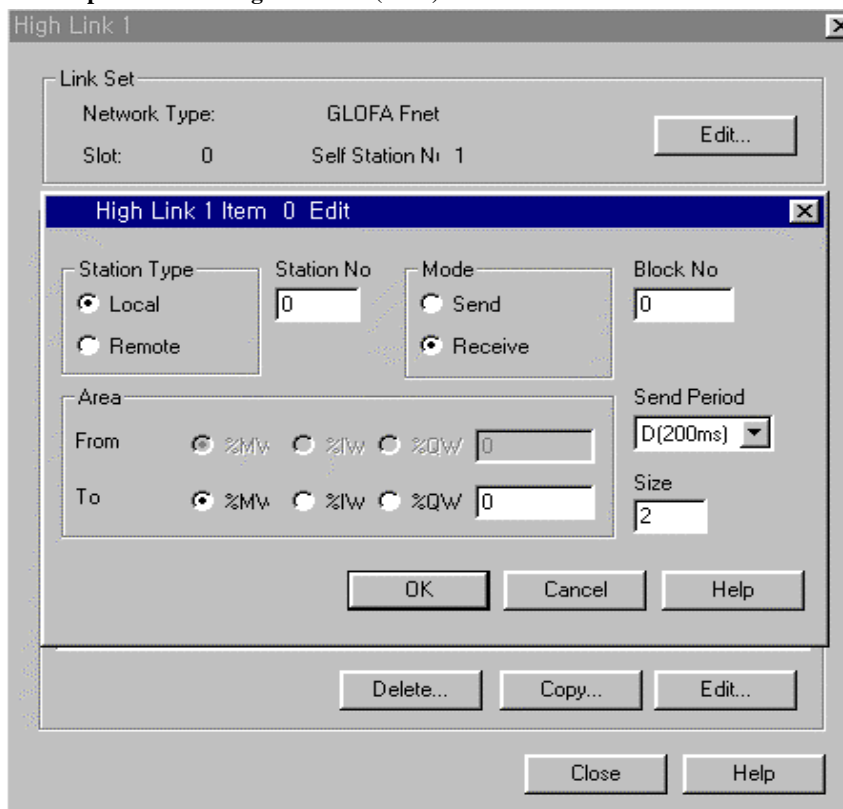

6.2.10 Ex.2 : *High speed link* of Master + Remote I/O station in Fnet

Ex. 1

Example that GM3 input module data(%IW0.1.0) is transmitted to GM4 remote output module(%QW0.0.0) and remote GM4 input module data(%IW0.1.0) is transmitted to GM3 output module(%QW0.2.0), in Fig. 6.2.10.

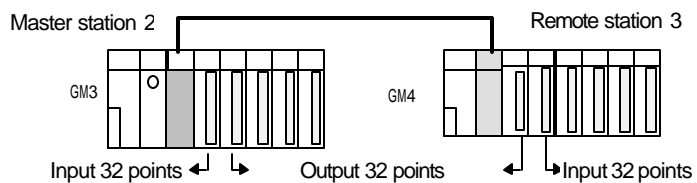

Fig. 6.2.10 Combined system of Fnet Master/Remote

Table 6.2.10 Configuration map of *high speed link* parameter

Tx/Rx structure		Area to read	Area to store	Size(word)	Block
GM3 (station 2)	TX:-->GM4	%IW0.1.0(GM3)	%QW0.0.0(GM4)	2 (32 points)	0
	RX:<--GM4	%IW0.1.0(GM4)	%QW0.2.0(GM3)	2 (32 points)	1

I/O configuration GM3 slot 0 : Communication module
 slot 1 : Input 32 points
 slot 2 : Output 32 points

GM4 slot 0 : Output 32 points
 slot 1 : Input 32 points
 Slot 0 is the right side of remote module.

- (1) Transmission parameter setting of GM3 station 2 (Reads GM3 input and outputs GM4 output module)

Station number setting is set to remote module station number when Tx/Rx is made with remote module

GM3 area →

Remote GM4 area →

- (2) Receive parameter setting of GM3 station 2 (Reads remote GM4 input and outputs GM3 output module)

Remote GM4 area →

GM3 area →

6.3 Function block service

6.3.1 Introduction

Function block is the function to read or write specific data or specific variable data to certain area or specific variable area of other station when certain event occurred, and this can be used various according to usage.

6.3.2 Programming procedure of *function block*

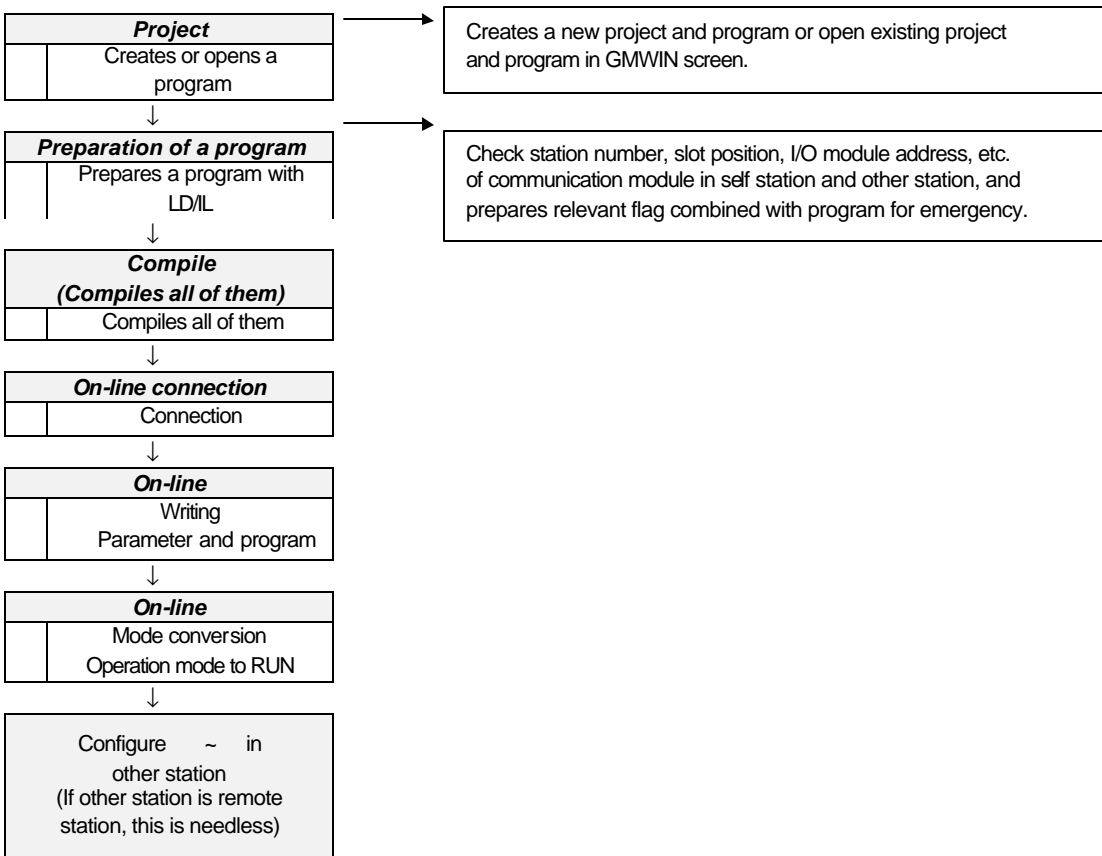

6.3.3 Types of function block

Function block that is used in preparing program is classified to 4 commands according to usage.

Type	Usage
READ, WRITE	Reads data of other station or writes data to other station
STATUS	Checks current status of PLC in other station
CONNECT	Establishes logical communication channel with other company' s PLC (applied to Mnet only)
DA4INI, etc.	Accesses special module in FSM

6.3.4 Input/Output of function block

This explains common I/O of function block .

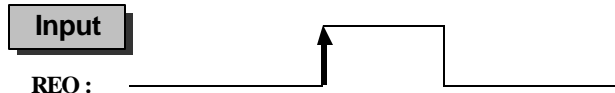

REQ : This is used as operation condition except CONNECT function block. This is operated at rising edge that is changed '0' to '1'. Once this is operated, this is not affected until receiving response from other station, and restarts from scan after NDR or ERR bit is set.



EN : Function block is operated if level is '1', and this should maintain state of '1' during service(Applied in CONNECT function block only : BOOL type). If EN bit is '1' when ERR bit is set to 'On', function block requests establishment service of communication channel again at next scan. If the value is changed from '1' to '0', it requests normal cancellation of channel established.

NET_NO :

This specifies the slot location of communication module to execute this function block among communication module that is mounted in basic base of GLOFA PLC. Right side of CPU in basic base is '0' slot.

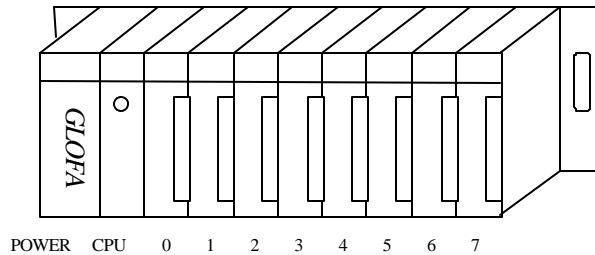

ST_NOH / ST_NOL :

Specify upper/lower number of other station number for Fnet, SAP number for Mnet. For details, see RDTYPE function block .

Output

NDR :

After *function block* is operated, this is set to 'On' if data is normally received, and set to 'Off' if appropriate scan is finished. If this bit is used for input condition of other *function block*, user can make a reliable communication.

ERR:

This is set to 'On' when error occurred after *function block* is operated, and maintains 'On' until next *function block* is operated and then becomes 'Off'. If error occurred, data is not received(See Received error from communication module of Chap. 6.3.7).

STATUS :

This shows detailed code value of error when error occurred after *function block* is operated, and maintains 'values' until next *function block* is operated and then becomes 'Off' (See Received error from communication module of Chap. 6.3.7).

6.3.5 How to use *function block*

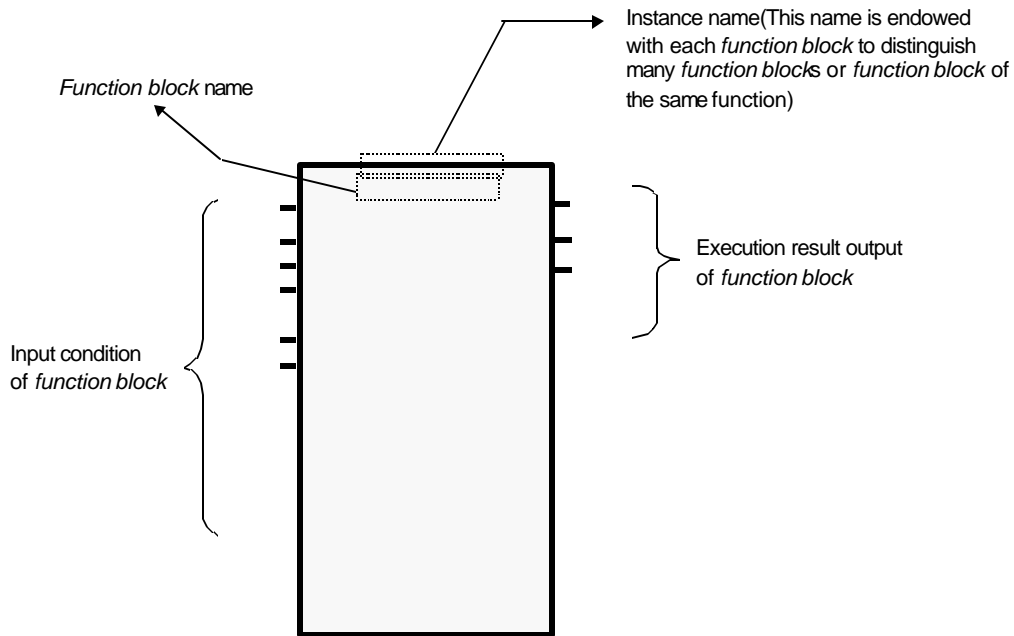

(In some *function block*, output result is outputted to left side)

6.3.6 Function block library of link

This explains each *function block*.

Table 6.3.6 Usable PLC type of *function block* and classification according to type

(O : Available, X : Not available)

Data type(bit size) \ PLC type		GM1 GM2	GM3	GM4	GM5	GM6	Remote	Name of <i>function block</i> (RDWR)
Basic type (Max. setting No. 4)	BOOL(1)	O	O	O	O	O	O	RD(WR)BOOL
	BYTE(8)	O	O	O	O	O	O	RD(WR)BYTE
	WORD(16)	O	O	O	O	O	O	RD(WR)WORD
	DWORD(32)	O	O	O	O	O	O	RD(WR)DWORD
	LWORD(64)	O	X	X	X	X	X	RD(WR)LWORD
	USINT(8)	O	O	O	O	O	X	RD(WR)USINT
	UINT(16)	O	O	O	O	O	X	RD(WR)UINT
	UDINT(32)	O	O	O	O	O	X	RD(WR)UDINT
	ULINT(64)	O	X	X	X	X	X	RD(WR)ULINT
	SINT(8)	O	O	O	O	O	X	RD(WR)SINT
	INT(16)	O	O	O	O	O	X	RD(WR)INT
	DINT(32)	O	O	O	O	O	X	RD(WR)DINT
	LINT(64)	O	X	X	X	X	X	RD(WR)LINT
	REAL(32)	O	X	X	X	X	X	RD(WR)REAL
	LREAL(64)	O	X	X	X	X	X	RD(WR)LREAL
	TIME(16)	O	O	O	O	O	X	RD(WR)TIME
	DATE(48)	O	O	O	O	O	X	RD(WR)DATE
TIME of DAY(48)	O	O	O	O	O	X	RD(WR)TOD	
DATE and TIME(48)	O	O	O	O	O	X	RD(WR)DT	
Block(Max. Fnet:120, Mnet:400 byte)		O	O	O	O	O	O	RD(WR)Block
Array type (Max. 100 byte)	BOOL	O	O	O	O	O	X	RD(WR)Array
	BYTE	O	O	O	O	O	X	RD(WR)Array
	WORD	O	O	O	O	O	O	RD(WR)Array
	DWORD	O	O	O	O	O	X	RD(WR)Array
	LWORD	O	X	X	X	X	X	RD(WR)Array
	USINT	O	O	O	O	O	X	RD(WR)Array
	UINT	O	O	O	O	O	X	RD(WR)Array
	UDINT	O	O	O	O	O	X	RD(WR)Array
	ULINT	O	X	X	X	X	X	RD(WR)Array
	SINT	O	O	O	O	O	X	RD(WR)Array
	INT	O	O	O	O	O	X	RD(WR)Array

6. Communication program

Data type(bit size)		PLC type						Name of <i>function block</i> (RDWR)
		GM1 GM2	GM3	GM4	GM5	GM6	Remote	
Array type (Max. 100 byte)	DINT	O	O	O	O	O	X	RD(WR)Array
	LINT	O	X	X	X	X	X	RD(WR)Array
	REAL	O	X	X	X	X	X	RD(WR)Array
	LREAL	O	X	X	X	X	X	RD(WR)Array
	TIME	O	O	O	O	O	X	RD(WR)Array
	DATE	O	O	O	O	O	X	RD(WR)Array
	TIME of DAY	O	O	O	O	O	X	RD(WR)Array
	DATE and TIME	O	O	O	O	O	X	RD(WR)Array

CONNECT

Establishes logical communication channel with other station(For connection with Mnet of other company)

Product name	GM1	GM2	GM3	GM4	GM5	GM6
Applicable						

Function block	Description
	<p>Input</p> <p>REQ : Request execution of <i>function block</i>(FB) at rising edge(0→1).</p> <p>NET_NO: Slot No.(0~7) that communication module of self station that this FB is to be transmitted is mounted.</p> <p>ST_NOH: Upper station number and SAP of communication module mounted in other station to establish channel.</p> <p>ST_NOL : Lower station number of communication module mounted in other station to establish channel.</p> <p>Output</p> <p>NDR : Set to ' On' , when data is received without error.</p> <p>ERR : Set to ' On' , when error occurred after <i>function block</i> is executed.</p> <p>STATUS : Detailed code value of error when error occurred.</p> <p>CH_EN : Result of channel establishment.</p>

Function and description

Communication with other station in Mnet is made after communication channel is established, and SAP is needed for this connection. SAP is classified to SAP(SSAP) of self station and SAP(DSAP) of other station, and manufacturer who supplies Mini-MAP communication module supplies user with SAP used in self station. Types of SAP include Association SAP, Associationless SAP, and Unspec. SAP.

- Association SAP
Channel(Initiate) service should be used during communication service, after channel is established.
- Associationless SAP
Not using channel(Initiate) service, and execute communication assuming that communication channel is established internally.
- Unspec. SAP
Both Association SAP and Associationless SAP function are contented.

If the SAP supplied from other company is Association SAP or if communication channel(Initiate) service should be used to communicate in other company's product, communication channel(Initiate) should be established using CONNECT *function block*. However, in communication with product of self-company, communication not using this *function block* is possible.

Operation condition of *function block* is operated not with edge but with level. If channel is established once, channel is maintained continuously as long as EN input level is ' 1' , and CH_EN bit is set to ' 1' when channel is established, and CH_EN bit is set to ' 0' when channel is cancelled by the request of self station or other station. Therefore, user can use CH_EN bit for the operation condition of other *function block*.

To communicate continuously, EN should be maintained to ' 1' , and channel is cancelled normally if En bit is set to ' 0' .

6. Communication program

EN

This is operated when level is '1', and should be maintained to '1' during service (BOOL).

NET_NO

Slot location(0~7) that communication module that data is transmitted using this *function block* is mounted, among communication modules mounted in main base of self station PLC.

ST_NOH

Upper station number and SAP of communication module mounted in other station to establish channel.

ST_NOH = SSAP(self station SAP) + DSAP(other station SAP) + Upper station number of communication module in other station.

ST_NOL

Lower station number of communication module mounted in other station to establish channel.

ST_NOL = Lower station number of other station

Ex.) Connection with Mnet of other company.

When communication channel is established with station B(other company's) in station A(self company's)

(Suppose that SAP = 4E of Mini-MAP module in other company's).

MAC address of A station : 16#00E091000000 (self company's),

MAC address of B station : 16#080070221C9A (other company's).

ST_NOH : 16#10(SAP of self station) 4E(SAP of other station) 0800(upper station number of communication module in other station).

Namely, ST_NOH = 16#104E0800.

ST_NOL = 16#70221C9A(lower station number of communication module in other station).

* SAP(SSAP) supplied with GLOFA Mini-MAP module for connection with Mnet of other company's has two types, 16#10 and 16#14.

NDR

This is set to 'On' when *function block* is operated and normally finished, and this is set to 'Off' when appropriate scan is finished.

ERR

This is set to 'On', if error occurred after *function block* is operated and the request for channel cancellation is received from other station with communication channel maintained, and this maintains 'On' until this *function block* is operated again in next scan.

STATUS

This shows detailed code value of error, and this maintains the value until this *function block* is operated again in next scan.

CH_EN

This is set to '1' when channel is established, and this is set to '0' when channel is cancelled. CH_EN is set to '1' when NDR is set to '1'. NDR bit is cleared at next time but CH_EN bit maintains '1' until channel is cancelled. CH_EN bit is set to '0' when ERR bit is set to '1', and maintains '0' until channel is established.

Example of program

Suppose that Mnet is used with Mnet of other company product and Mini-MAP module of self station is mounted in slot 0. If MAC address of other station is 16#080070221C9A and 1 word(16 bit) of Y2 in other station area is stored in %MW100 area in self station, after channel is established with Mini-MAP of other company(Suppose that other company' s SAP = 4E).

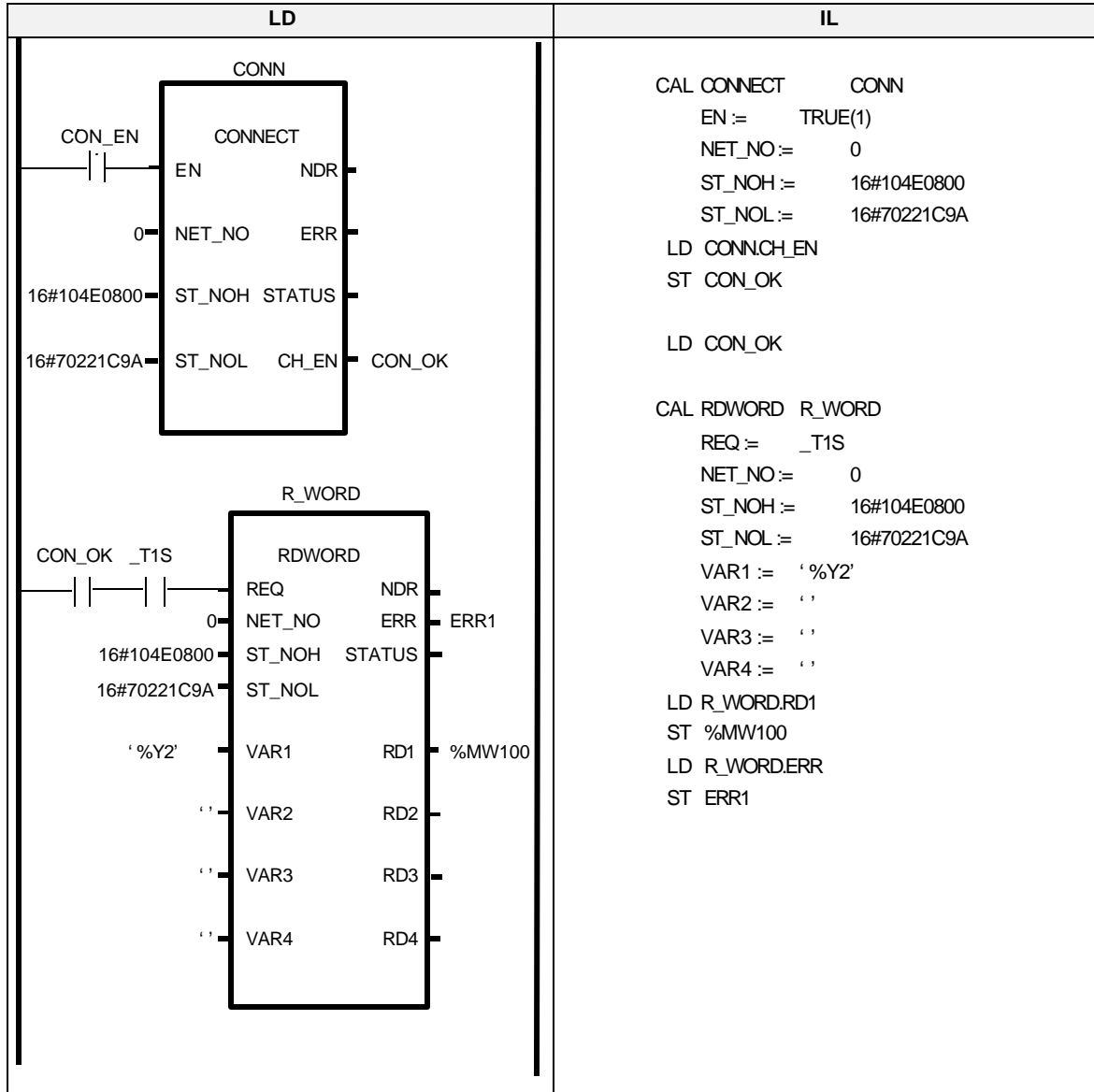

- CON_EN is a variable which has initialization value, 1.
 In above example, instance name of *function block* CONNECT is CONN. If ST_NOH = 16#104E0800 and ST_NOL = 16#70221C9A, *function block* operates all the time, and service is transmitted and received through communication module mounted in slot 0 of main base. If service is in proceeding and CH_EN bit is set, this means that channel is established between communication module of self station and communication module of other station to be communicated. Y2 of other station is read per 1 sec. with RDWORD function and it is stored in %MW100 area of self station.

RDARRAY

Reads data of array type from other station
(Max. 100 byte)

Product name	GM1	GM2	GM3	GM4	GM5	GM6
Applicable						

Function block	Description
	<p>Input</p> <p>REQ : Request execution of <i>function block</i>(FB) at rising edge(0→1).</p> <p>NET_NO: Slot No.(0~7) that communication module of self station that this FB is to be transmitted is mounted.</p> <p>ST_NOH: Fixed to 0 in Fnet (In Mnet, upper station number and SAP of communication module mounted in other station).</p> <p>ST_NOL: Station number of communication module mounted in other station (In Mnet, lower station number).</p> <p>VAR: Variable identifier(direct address not available) to read data(variable defined in other station).</p> <p>RDARRAY: Self station area that ARRAY data received from other station is to be stored.</p> <p>Output</p> <p>NDR: Set to ' On' , when data is received without error.</p> <p>ERR: Set to ' On' , when error occurred after <i>function block</i> is executed.</p> <p>STATUS: Detailed code value of error when error occurred.</p>

Function and description

This is the *function block*, which is used to read data of other station defined as array type.

Data can be read not using direct variable of other station(Ex. : %I, %Q, and %M area) but using variable name used in other station. Variable name used should be specified in access variable list of other station, and the variable name, used for path name when access variable is specified, should be defined again as array type in global variable list(definition is not necessary in self station). The data type, which is the same as the array defined in other station, should be used.

ST_NOH / ST_NOL

Station number of communication module in other station(For details, see RDTYPE *function block*).

VAR:

Variable identifier to be read from other station.

NDR / ERR / STATUS

Displays execution result of *function block* (For details, see RDTYPE *function block*).

RDARRAY

Self station area that array data received from other station is to be stored.

(The data type, which is the same as the array defined in other station, should be used)

Example of program

Suppose that Fnet is used and Fnet module is mounted in slot 0.

If station number of other station is station 3, and variable of ABC defined as array in other station is read and it is stored in array variable of CBA in self station. (Access for ABC variable in station 3 and register global variable and set REQ condition with a period of 1 second)

- Variable registration for station 3 (For registration method of access variable, see 6.3.8 Access variable registration).

Variable registration	Variable name	Access path	Description
Access variable registration	ABC	DEF(Ex.)	Set the path name of access variable ABC to DEF
Resource global variable registration	RES1.DEF	-	Register again DEF to global variable

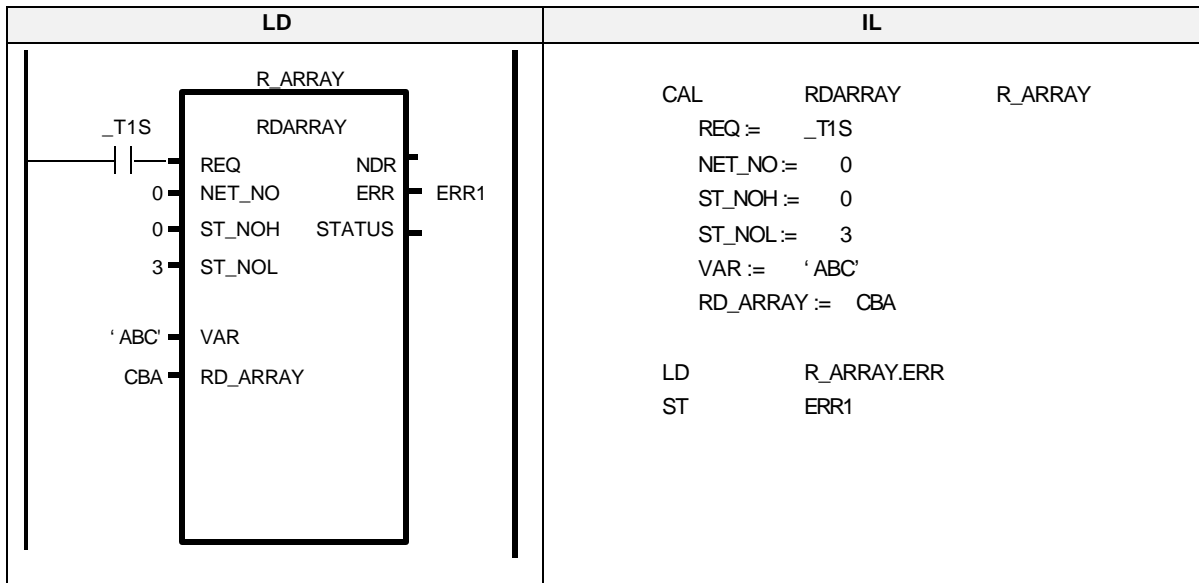

Example of program

Suppose that Mnet is used and communication is made with Mnet of self company product and Mini-MAP module mounted in slot 1.

If MAC address of other station is 16#00E091000010 and variable of ABC defined as array in other station is read, and it is stored in array variable of CBA in self station(Access for ABC variable of other station. Register global variable as the Ex. of Fnet shown above, and set REQ condition with a period of 1 second)

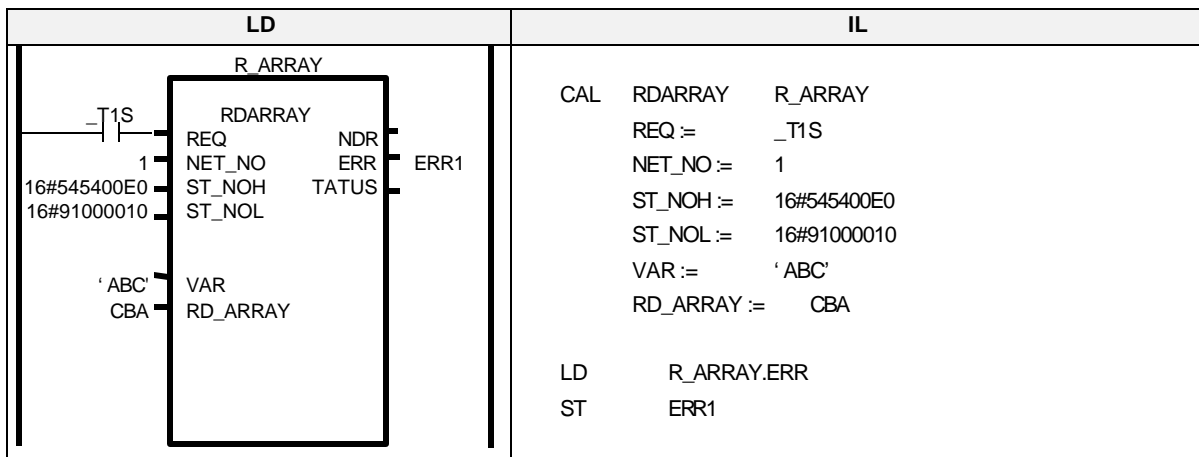

WRARRAY

Writes data of array type to other station
(Max. 100 byte)

Product name	GM1	GM2	GM3	GM4	GM5	GM6
Applicable						

Function block	Description
	<p>Input</p> <p>REQ : Request execution of <i>function block</i>(FB) at rising edge(0→1).</p> <p>NET_NO : Slot No.(0~7) that communication module of self station that this FB is to be transmitted is mounted.</p> <p>ST_NOH : Fixed to 0 in Fnet (In Mnet, upper station number and SAP of communication module mounted in other station).</p> <p>ST_NOL : Station number of communication module mounted in other station (In Mnet, lower station number).</p> <p>VAR : Variable identifier(direct address not available) to read data(variable defined in other station).</p> <p>SD_ARRAY : Area for array data of self station to be transmitted to other station.</p> <p>Output</p> <p>NDR : Set to ' On' , when data is transmitted without error.</p> <p>ERR : Set to ' On' , when error occurred after <i>function block</i> is executed.</p> <p>STATUS : Detailed code value of error when error occurred.</p>

Function and description

This is the *function block*, which is used to transmit array data of self station to variable defined as array type in other station. Data can be transmitted not to direct variable(Ex. : %I, %Q, and %M area) but to variable name used in other station. Variable name used should be specified in access variable list of other station, and the variable name, used for path name when access variable is specified, should be defined again as array type in global variable list(definition is not necessary in self station). The data type, which is the same as the array defined in other station, should be used(Max. 100 byte).

ST_NOH / ST_NOL

Station number of communication module in other station(For details, see RDTYPE *function block*).

VAR :

Variable identifier to transmit to other station(variable defined in other station).

SD_ARRAY

Array area of self station, which has the data to be transmitted to other station.
(The data type, which is the same as the array defined in other station, should be used)

NDR / ERR / STATUS

Displays execution result of *function block* (For details, see RDTYPE *function block*).

Example of program

Suppose that Fnet is used and Fnet module is mounted in slot 0.

If station number of other station is station 3, and data of CBA array variable in self station is transmitted to variable of ABC defined as array in other station(Access for ABC variable in station 3 and register global variable and set REQ condition with a period of 1 second).

- Variable registration for station 3 (For registration method of access variable, see 6.3.8 Access variable registration).

Variable registration	Variable name	Access path	Description
Access variable registration	ABC	DEF(Ex.)	Set the path name of access variable ABC to DEF
Resource global variable registration	RES1.DEF	-	Register again DEF to global variable

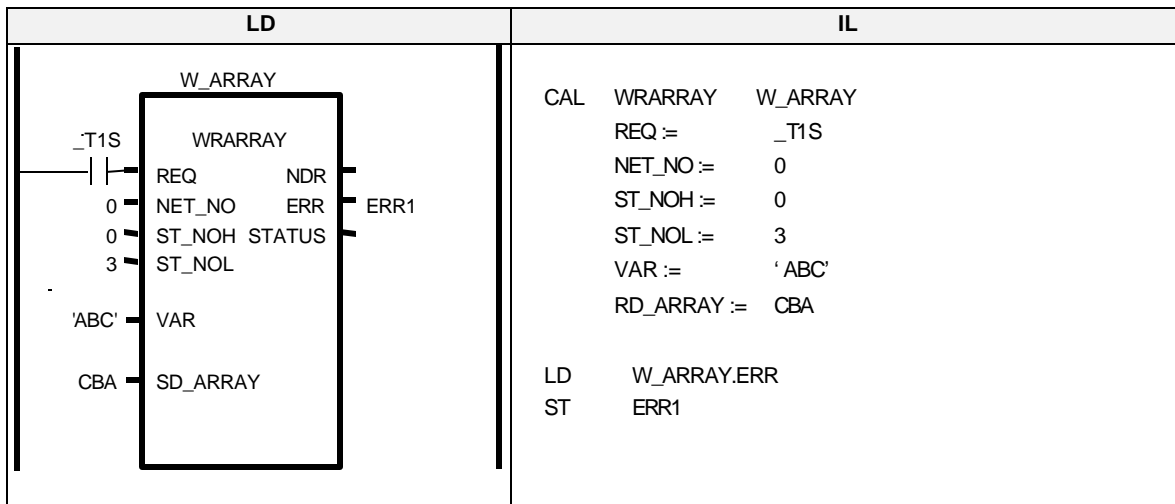

Example of program

Suppose that Mnet is used and communication is made with Mnet of self company product and Mini-MAP module mounted in slot 1.

If MAC address of other station is 16#00E091000010 and data of CBA array variable in self station is transmitted to variable of ABC defined as array in other station(Access for ABC variable of other station. Register global variable as the example of Fnet shown above, and set REQ condition with a period of 1 second).

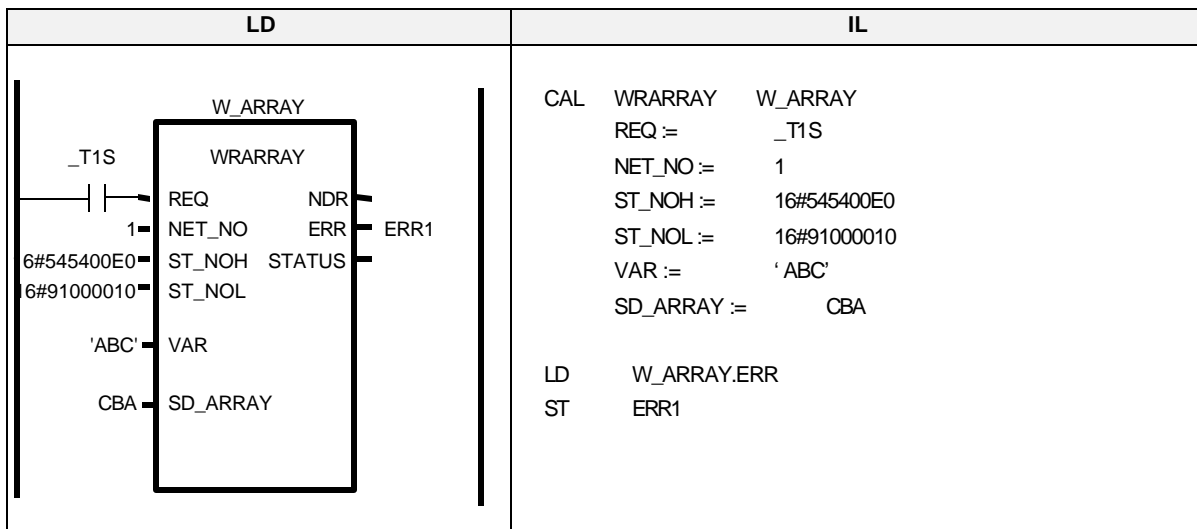

RDBLOCK

Reads continuous data from other station
(Max. Fnet : 120 byte, Mnet : 400 byte)

Product name	GM1	GM2	GM3	GM4	GM5	GM6
Applicable						

Function block	Description
<p>The diagram shows a rectangular box labeled 'RDBYBLK'. On the left side, there are input terminals: 'REQ' (BOOL), 'NET_NO' (USINT), 'ST_NOH' (UDINT), 'ST_NOL' (UDINT), 'VAR' (STRING), 'DATA_LEN' (UINT), and 'RDVAR' (BYTE). On the right side, there are output terminals: 'NDR' (BOOL), 'ERR' (BOOL), 'STATUS' (USINT).</p>	<p>Input</p> <p>REQ : Request execution of <i>function block</i>(FB) at rising edge(0→1).</p> <p>NET_NO : Slot No.(0~7) that communication module of self station that this FB is to be transmitted is mounted.</p> <p>ST_NOH : Fixed to 0 in Fnet (In Mnet, upper station number and SAP of communication module mounted in other station).</p> <p>ST_NOL : Station number of communication module mounted in other station (In Mnet, lower station number).</p> <p>VAR : Start address of other station to read data(variable identifier is not available).</p> <p>RDVAR : Area that the data received from other station is to be stored.</p> <p>DATA_LEN : Number of data to be read.</p> <p>Output</p> <p>NDR : Set to ' On' , w hen data is received without error.</p> <p>ERR : Set to ' On' , when error occurred after <i>function block</i> is executed.</p> <p>STATUS : Detailed code value of error when error occurred.</p>

Function and description

This is the *function block*, which is used to read massive data continuously from certain address of other station. Only byte should be used for data type, and direct address(%I, %Q, and %M) should be used for variable name.

ST_NOH/ST_NOL

Station number of communication module in other station(For details, see RDTYPE *function block*).

VAR

This is start address to read data from other station. Only direct address can be used, and only byte can be used for data type.

Ex.) %MB100 – From 100th byte area.

%IB0.2.1 – From first byte area among input area allocated in second slot(2) of main base(0).

%QB0.3.1 – From first byte area among input area allocated in third slot(3) of main base(0).

RDVAR

Area of self station that the data read from other station is to be stored(specified as byte).

DATA_LEN

Byte number of data to be read from other station.

NDR/ERR/STATUS

This shows the execution result of *function block*(For details, see RDTYPE *function block*).

Example of program

Suppose that Fnet is used and Fnet module is mounted in slot 0.

If station number of other station is station 5, and 100 byte from area %MB0 of other station is read and it is stored in area from %MB200 to %MB299 of self station(REQ condition is set with a period of 1 second).

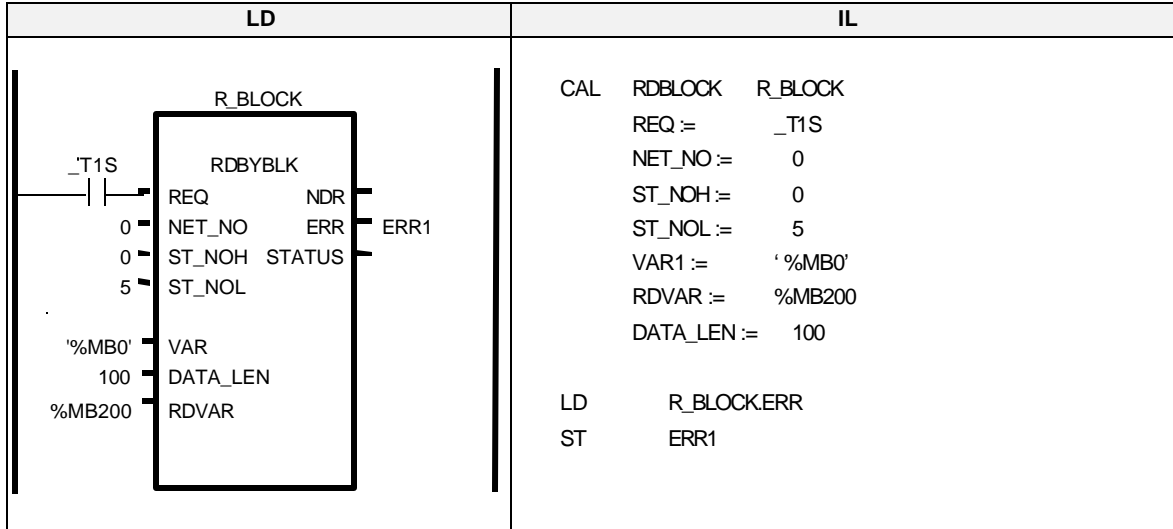

Example of program

Suppose that Mnet is used and communication is made with Mnet of self company's product and Mini-MAP module mounted in slot 1.

If MAC address of other station is 16#00E091000010, and 100 byte from area %MB0 of other station is read and it is stored to area from %MB200 to %MB299 of self station(REQ condition is set with a period of 1 second).

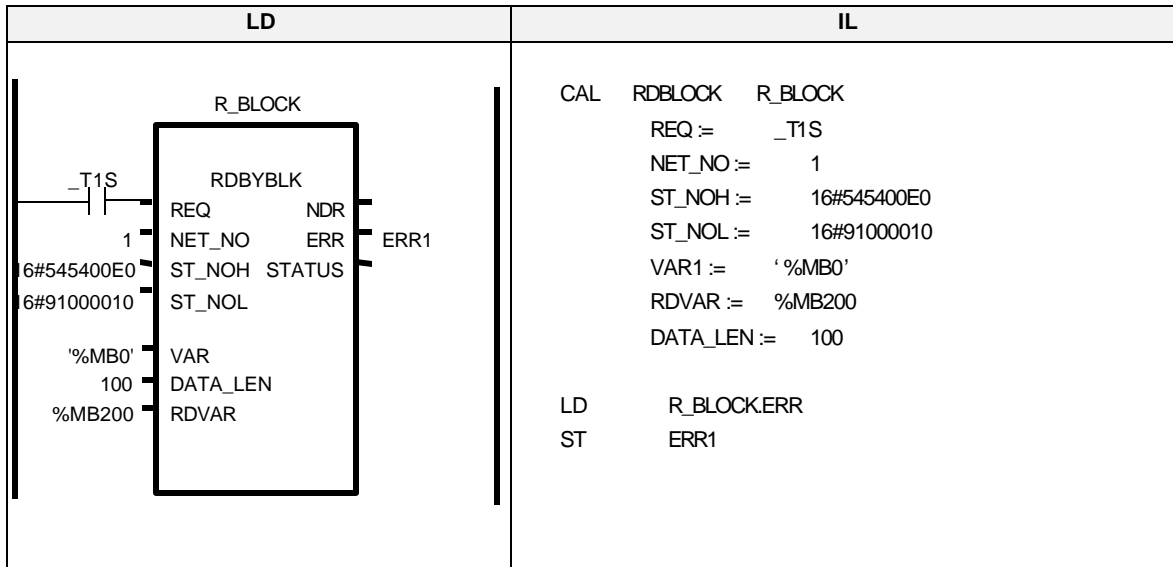

WRBLOCK

Writes continuous data to other station
(Max. Fnet : 120 byte, Mnet : 400 byte)

Product name	GM1	GM2	GM3	GM4	GM5	GM6
Applicable						

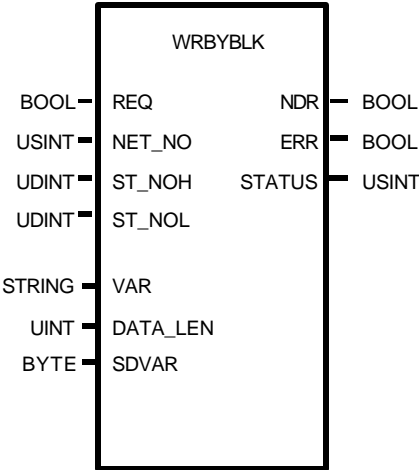
Function block	Description
	<p>Input</p> <p>REQ : Request execution of <i>function block</i>(FB) at rising edge(0→1).</p> <p>NET_NO : Slot No.(0~7) that communication module of self station that this FB is to be transmitted is mounted.</p> <p>ST_NOH : Fixed to 0 in Fnet (In Mnet, upper station number and SAP of communication module mounted in other station).</p> <p>ST_NOL : Station number of communication module mounted in other station (In Mnet, lower station number).</p> <p>VAR : Start address of other station to write data(variable identifier is not available).</p> <p>SDVAR : Area that the data to be transmitted to other station is stored.</p> <p>DATA_LEN : Number of data to transmit.</p> <p>Output</p> <p>NDR : Set to ' On' , when data is transmitted without error.</p> <p>ERR : Set to ' On' , when error occurred after <i>function block</i> is executed.</p> <p>STATUS : Detailed code value of error when error occurred.</p>

Function and description

This is the *function block*, which is used to write massive data continuously to certain address of other station. Only byte should be used for data type, and direct address(%I, %Q, and %M) should be used for variable name.

ST_NOH / ST_NOL

Station number of communication module in other station(For details, see RDTYPE *function block*).

VAR

This is start address to write data to other station. Only direct address can be used, and only byte can be used for data type.

Ex.) %MB100 – From 100th byte area.

%IB0.2.1 – From first byte area among input area allocated in second slot(2) of main base(0).

%QB0.3.1 – From first byte area among input area allocated in third slot(3) of main base(0).

SDVAR

Area of self station that the data to be transmitted to other station is stored(specified as byte).

DATA_LEN

Byte number of data to transmit to other station.

NDR / ERR / STATUS

This shows the execution result of *function block*(For details, see RDTYPE *function block*).

Example of program

Suppose that Fnet is used and Fnet module is mounted in slot 0.

If station number of other station is station 5, and data in the area from %MB200 to %MB299 of self station is transmitted to area from %MB0 to %MB99 of other station(REQ condition is set with a period of 1 second).

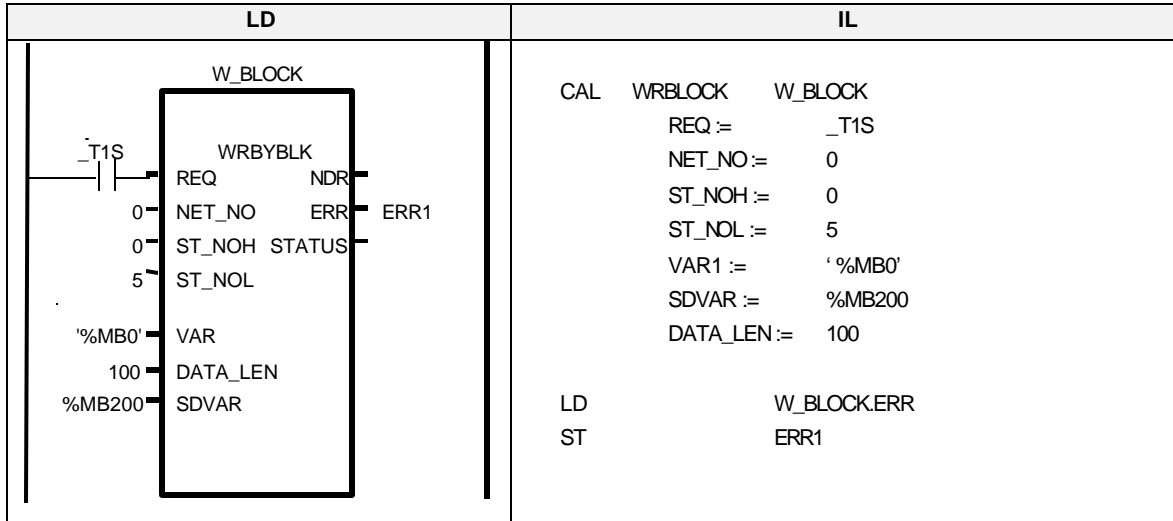

Example of program

Suppose that Mnet is used and communication is made with Mnet of self company's product and Mini-MAP module mounted in slot 1.

If MAC address of other station is 16#00E091000010, and data in the area from %MB200 to %MB299 of self station is transmitted to area from %MB0 to %MB99 of other station(REQ condition is set with a period of 1 second).

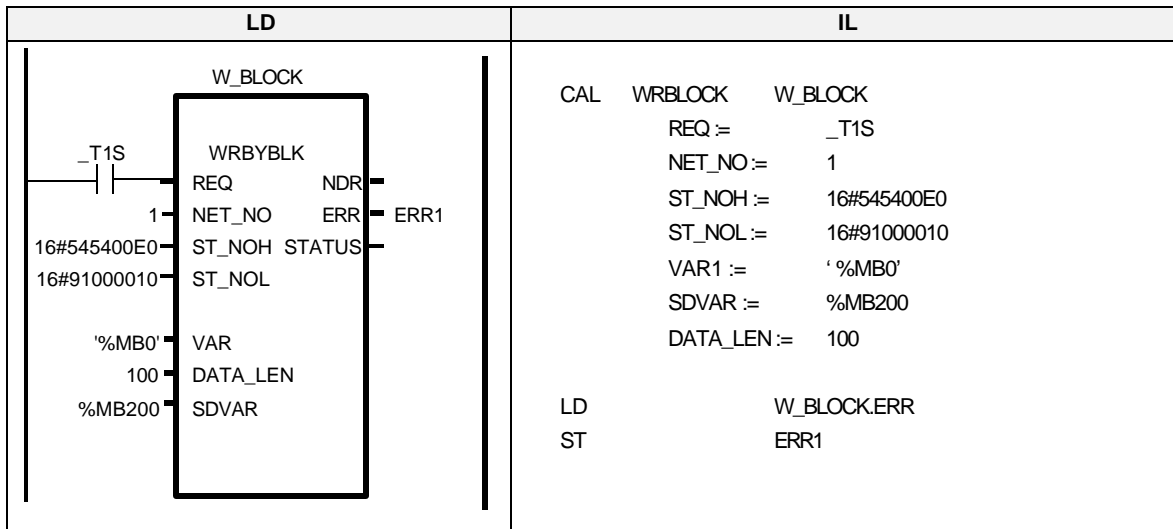

RDTYPE(BOOL.DT)

Reads data from other station

Product name	GM1	GM2	GM3	GM4	GM5	GM6
Applicable						

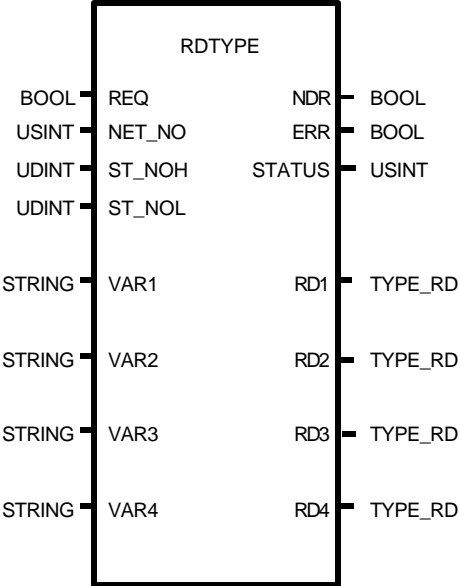
Function block	Description
	<p>Input</p> <p>REQ : Request execution of <i>function block</i>(FB) at rising edge(0→1).</p> <p>NET_NO : Slot No.(0~7) that communication module of self station that this FB is to be transmitted is mounted.</p> <p>ST_NOH : Fixed to 0 in Fnet (In Mnet, upper station number and SAP of communication module mounted in other station).</p> <p>ST_NOL : Station number of communication module mounted in other station (In Mnet, lower station number).</p> <p>VAR1~4 : Direct address or variable identifier of other station to read data.</p> <p>Output</p> <p>NDR : Set to ' On' , when data is received without error.</p> <p>ERR : Set to ' On' , when error occurred after <i>function block</i> is executed.</p> <p>STATUS : Detailed code value of error when error occurred.</p> <p>RD1~4 : Area of self station that data received from other station is to be stored.</p>

Function and description

This is the *function block*, which reads data of other station and stores it to designated location of self station. Use appropriate *function block* according to the data type to be processed.

Ex.) Choose "RDWORD" in *function block* list for processing of word type data(16 bits).

ST_NOH / ST_NOL

Specifies upper/lower station number.

- Fnet : ST_NOH = 0 (Fixed), ST_NOL = other station number (For station 10, decimal uses 10 and hexadecimal uses 16#A)
- Mnet(when Mini-MAP is used) : ST_NOH = SSAP(self station SAP) + DSAP(other station SAP) + Upper station number in communication module of other station
ST_NOL = Lower station number of other station
- SAP(Service Access Point) : This is a factor, which determines the characteristic of service used in communication and connects each other according to the characteristic of upper application layer. 16#54, 16#58, 16#5C, 16#60, and 16#64 are possible for communication with self company's product(Mnet). 16#10 and 16#14 are provided for communication between Mnet of self company and Mini-MAP module of other company.

Ex.1) Communication with Mnet of self company

When data of station B is read at station A.

MAC address of station A : 16#00E091000000, MAC address of station B : 16#00E091000003.

ST_NOH : 16#54(self station SAP) 58(other station SAP) 00E0(upper station number of communication module in other station)

Namely, ST_NOH = 16#545800E0

6. Communication program

ST_NOL = 16#91000003(lower station number of communication module in other station)

* MAC address is written at side part of product.

Ex.2) Communication with Mnet of other company

When data of station B(other company) is read at station A(self company) (Suppose that SAP = 4E for Mini-MAP module of other company).

MAC address of station A : 16#00E091000000(self company), MAC address of station B :
16#080070221C9A (other company).

ST_NOH : 16#10(self station SAP) 4E(other station SAP) 0800(upper station number of communication module in other station).

Namely, ST_NOH = 16#104E0800.

ST_NOL = 16#70221C9A(lower station number of communication module in other station)

VAR1 ~ VAR4

These are direct address or variable identifier of other station that data is to be read, and string is used for these.

Data type should be identical with data type of *function block* (Ex. Data type of VAR1 ~ 4 should use word type when "RDWORD" *function block* is used).

• Fnet :

Direct address : Directly reads other station area.

Available data types are BOOL, BYTE, WORD, DWORD, LWORD(GM1/2).

Ex.) When reading 100thbit area of memory in other station : '%MX100' .

Ex.) When reading input 16 points of second slot(2) in main base(0) of other station : '%IW0.2.0' .

Variable identifier : This is used to read the data of other station, and this should be registered in access variable area of other station and variable type should be identical with data type to be received(For registration method of access variable, see 6.3.8 Access variable registration)

• Mnet :

Communication with self company Mnet :

Using method of direct address and variable identifier is the same as Fnet.

Communication with other company Mnet :

For direct address, specify direct address used or supplied from other company(variable identifier is not available).

* Enter string indication(' ') for location, which is not used in VAR1~VAR4.

RD1 ~ RD4

This specifies self station area that received data from other station is to be stored.

VAR1 input data is stored in RD1, and VAR2, 3 and 4 are stored in each of RD2, 3, and 4.

Data type should be identical with data type of *function block*.

NDR

This is set to 'On' if *function block* is operated and normally finished, and set to 'Off' if appropriate scan is finished.

ERR

This is set to 'On' when error occurred after *function block* is operated, and maintains 'On' until next *function block* is operated. If error occurred, data is not received.

STATUS

This shows detailed code value of error when error occurred after *function block* is operated, and maintains 'On' until next *function block* is operated(For code value, see page 6-55).

Example of program

Suppose that Fnet is used and Fnet module is mounted in slot 0.

If station number of other station is 16#1A, and area %MW100 of other station is read and it is stored in area %MW200 of self station(Use RDWORD function block and set REQ condition with a period of 1 second).

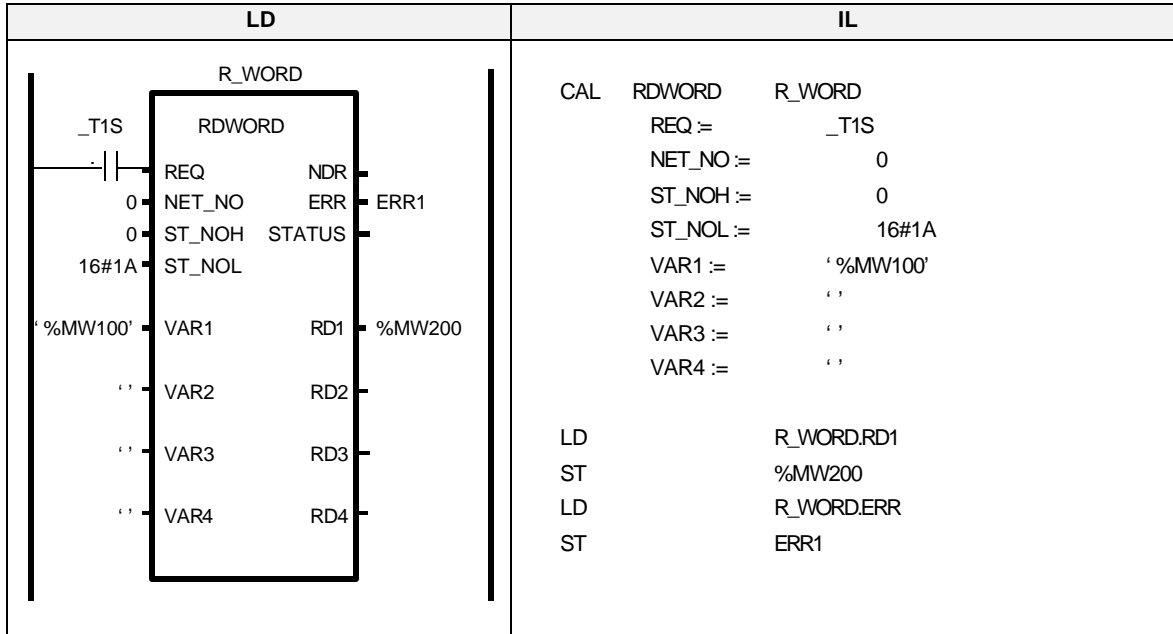

Example of program

Suppose that Mnet is used and communication is made with Mnet of self company product and Mini-MAP module mounted in slot 1.

If MAC address of other station is 16#00E091000010(written at side part of Mini-MAP module in other station), and area %MW100 of other station is read and it is stored in area %MW200 of self station(Use RDWORD function block and set REQ condition with a period of 1 second).

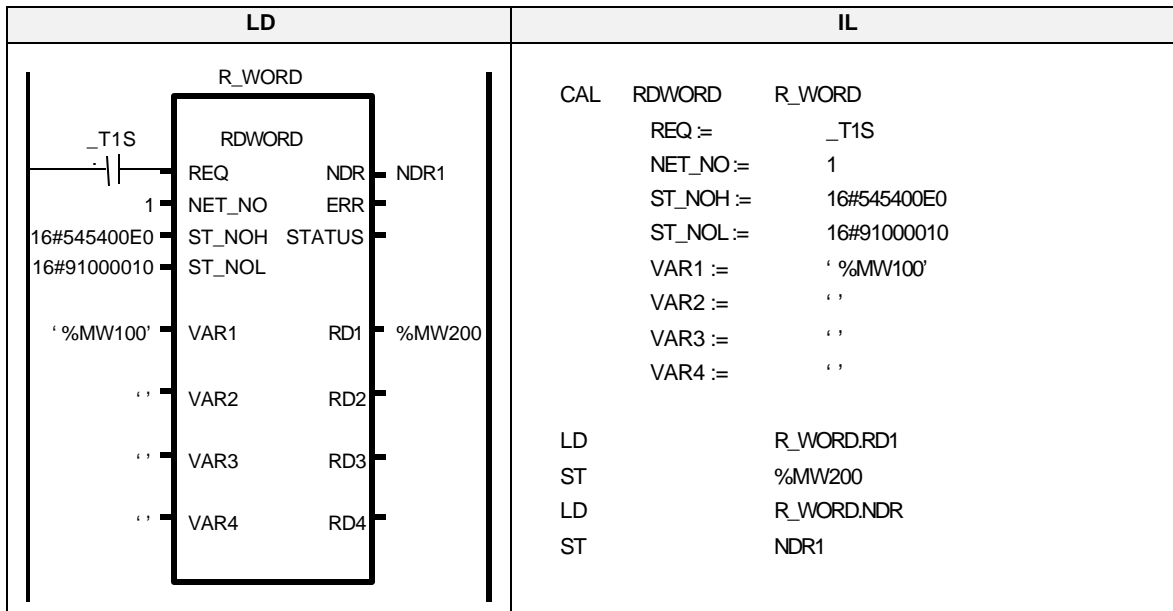

WRTYPE(BOOL.DT)

Writes data to other station

Product name	GM1	GM2	GM3	GM4	GM5	GM6
Applicable						

Function block	Description
	<p>Input</p> <p>REQ : Request execution of <i>function block</i>(FB) at rising edge(0→1).</p> <p>NET_NO: Slot No.(0~7) that communication module of self station that this FB is to be transmitted is mounted.</p> <p>ST_NOH: Fixed to 0 in Fnet (In Mnet, upper station number and SAP of communication module mounted in other station).</p> <p>ST_NOL: Station number of communication module mounted in other station (In Mnet, lower station number).</p> <p>VAR1~4: Direct address or variable identifier of other station to write data.</p> <p>SD1~4: Data to be transmitted to other station or area of self station.</p> <p>Output</p> <p>NDR: Set to ' On' , when data is transmitted without error.</p> <p>ERR: Set to ' On' , when error occurred after <i>function block</i> is executed.</p> <p>STATUS: Detailed code value of error when error occurred.</p>

Function and description

This is the *function block*, which transmits area of self station or specific data to other station through communication module of self station.

Ex.) Choose “WRBYTE” in *function block* list for processing of byte type data(8 bits).

For detailed contents about I/O, see “RDTYPE” *function block*.

ST_NOH / ST_NOL

Specifies upper/lower station number.

VAR1 ~ VAR4

These are direct address or variable identifier of other station that data is transmitted, and string is used for these.

Data type should be identical with data type of *function block*(For example, data type of VAR1 ~ 4 should use byte type when direct address is used in “WRBYTE” *function block*. It is set automatically when variable identifier is used).

* Enter string indication(‘ ’) for the location, which is not used in VAR1~VAR4.

SD1 ~ SD4

This specifies the value to be transmitted to other station or self station area.

Data specified in SD1 is transmitted to other station area specified in VAR1. Data of SD2, 3, and 4 are transmitted to each area of R2, 3, and 4.

Data type should be identical with data type of *function block*.

* Enter ‘ 0’ for the location, which is not used in SD1~SD4.

NDR / ERR / STATUS :

See “RDTYPE” *function block*.

Example of program

Suppose that Fnet is used and Fnet module is mounted in slot 0.

If data in self station area of %MW0 is transmitted to area %MW100 of other station 5 (Use WRWORD function block and set REQ condition with a period of 1 second).

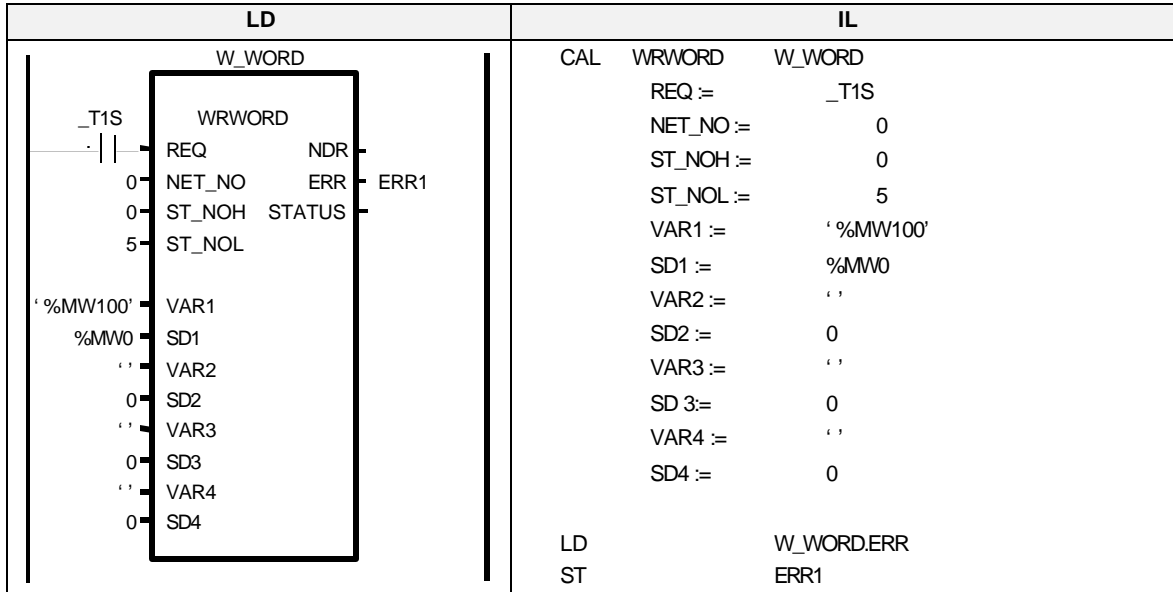

Example of program

Suppose that Mnet is used and communication is made with Mnet of self company product and Mini-MAP module mounted in slot 1.

If MAC address of other station is 16#00E091000010(written a side part of Mini-MAP module in other station), and area %MW0 of self station is read and it is transmitted in area %MW100 of other station(Use WRWORDfunction block and set REQ condition with a period of 1 second).

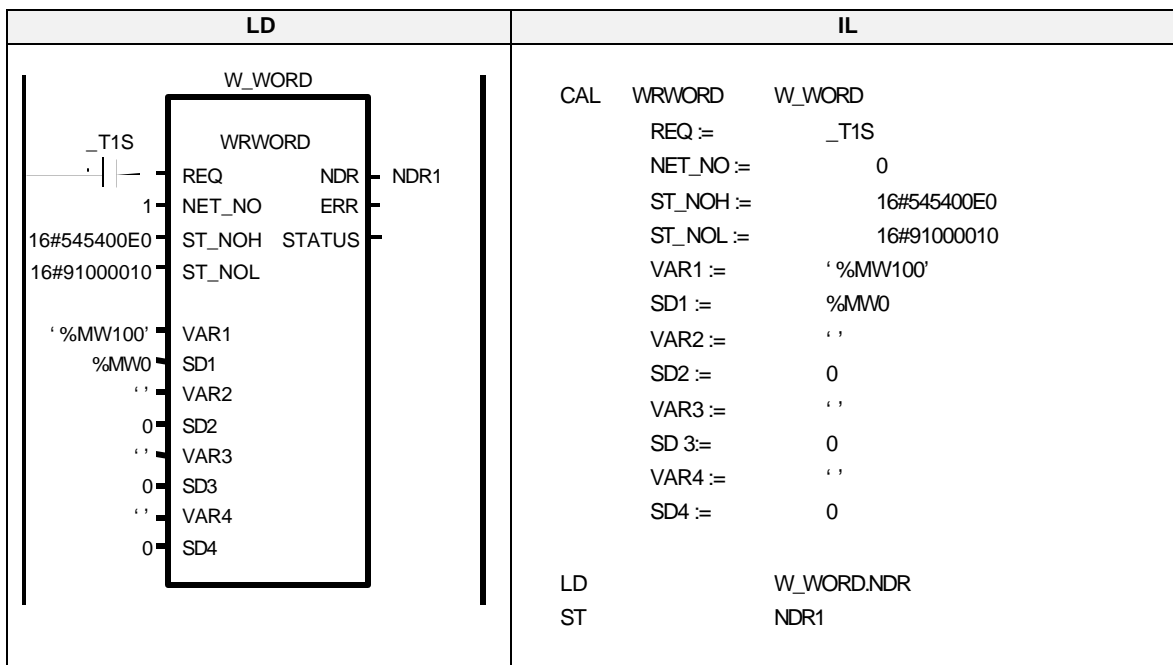

STATUS

Reads status of other station

Product name	GM1	GM2	GM3	GM4	GM5	GM6
Applicable						

Function block	Description
	<p>Input</p> <p>REQ : Request execution of <i>function block</i>(FB) at rising edge(0→1).</p> <p>NET_NO: Slot No.(0~7) that communication module of self station that is mounted.</p> <p>ST_NOH: Fixed to 0 in Fnet (In Mnet, upper station number and SAP of communication module mounted in other station).</p> <p>ST_NOL: Station number of communication module mounted in other station (In Mnet, lower station number).</p> <p>Output</p> <p>NDR: Set to 'On', when data is transmitted without error.</p> <p>ERR: Set to 'On', when error occurred after <i>function block</i> is executed.</p> <p>STATUS: Detailed code value of error when error occurred.</p> <p>LOG: Level of function, which is usable with communication service. This is always set to '0'.</p> <p>PHY: H/W operation condition of other PLC.</p> <p>USR_D: Integrated data of PLC condition.</p>

Function and description

This is the *function block*, which is used to check the status of other station.

ST_NOH / ST_NOL

Station number of other station communication module(For details, see RDTYPE *function block*).

LOG

This shows the level of function, which is usable with communication service(Logical state).

0= STATE-CHANGE-ALLOWED.

PHY

This is physical state, and shows H/W operation status of PLC.

0= OPERATIONAL(In operating)

1= PARTIALLY-OPERATIONAL-H/W(Not all of PLC and peripheral modules are normally operating).

2= INOPERABLE-H/W(Operation is stopped by error occurrence).

3= NEED-COMMISSION-H/W(In operating, but data is not reliable).

USR_D

This shows integrated status of PLC, and supplies 128 bit of bit array to control and monitor the system.

Example of program

Suppose that Fnet is used and Fnet module is mounted in slot 0.

If integrated information for other station 5 is read with RDST variable defined as array 128 bit.

(REQ condition is set with a period of 1 second).

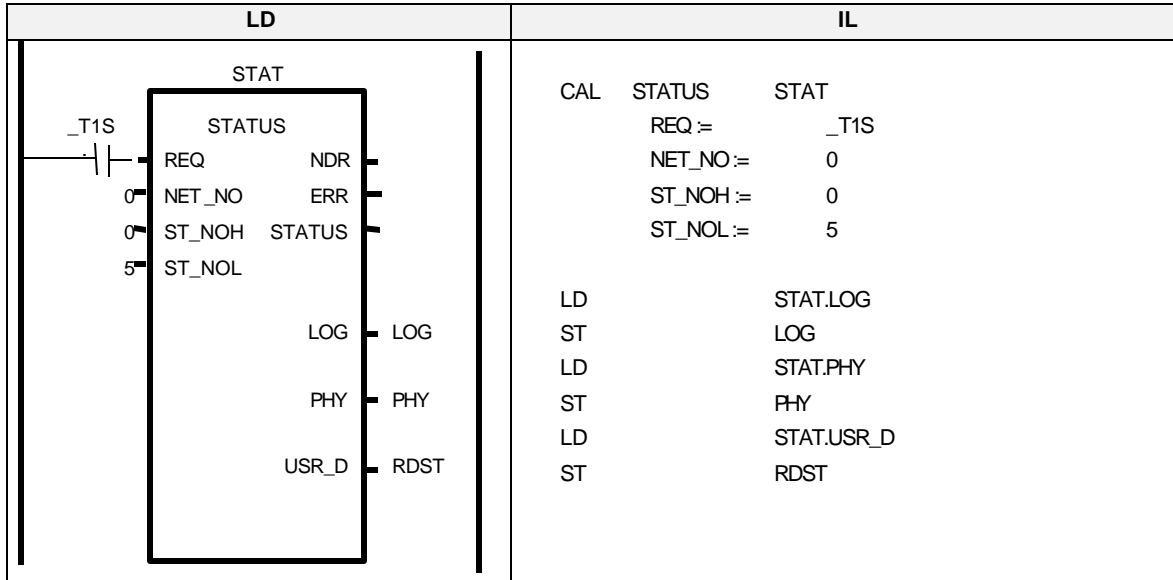

Example of program

Suppose that Mnet is used and communication is made with Mnet of self company's product and Mini-MAP module mounted in slot 1.

If integrated information of Mini-MAP module that MAC address of other station is 16#00E091000010(written at side part of Mini-MAP module in other station) is read with RDST variable defined as array 128 bit.

(REQ condition is set with a period of 1 second).

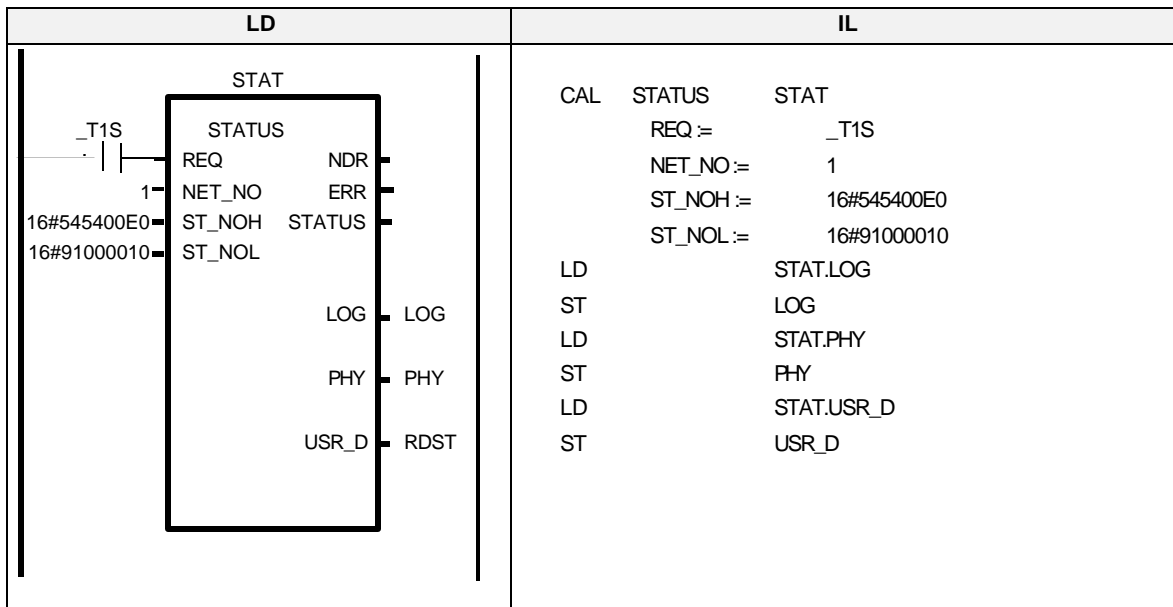

Contents for bit array stored as USR_D in STATUS *function block* : [0]~[127]

Bit No.	Representative contents	Segment of bit	Detailed contents	Description
S[0]~ S[7]	CPU_TYPE	0x00	GM1	CPU type is indicated with the value of S[7]~S[0].
		0x01	GM2	
		0x02	GM3	
		0x03	GM4	
		0x04	GM5	
		0x05	GM3_FSM	
		0x06	GM3_FSM	
		0x07	SRU	
		0x08	FAM	
		0x09	PMU500	
		0x0A	PADT	
		0x0B	GM3_FSRM	
		0x10	GMR	
		0x22	GK3	
		0x23	GK4	
		0x24	GK5	
		0x25	GK3_FSM	
0x26	GK3_FSM			
0x27	GK6 A			
0x28	GK6 B			
0x5F	GM6 A			
0x60	GM6 B			

S[8]~ S[15]	_VERSION_NO	S[8]~ S[11]	_VERSION_NO Lower indication	Ex.) If v3.1 is indicated (1: S[11]~S[8], indicated as decimal, 3: S[15]~S[12], indicated as decimal)
		S[12]~ S[15]	_VERSION_NO Upper indication	

S[16]	_SYS_STATE	BIT 0	Local control	Indicates status that operation mode can be converted only by mode key or PADT.
S[17]		BIT 1	STOP	Indicates operation state of CPU.
S[18]		BIT 2	RUN	Indicates operation state of CPU.
S[19]		BIT 3	PAUSE	Indicates operation state of CPU.
S[20]		BIT 4	DEBUG	Indicates operation state of CPU.
S[21]		BIT 5	Cause of operation mode conversion	Converts operation mode using key.
S[22]		BIT 6	Cause of operation mode conversion	Converts operation mode using PADT.
S[23]		BIT 7	Cause of operation mode conversion	Converts operation mode using remote PADT.
S[24]		BIT 8	Cause of operation mode conversion	Converts operation mode using communication.
S[25]		BIT 9	Stop by STOP function	Stops after finishing scan by STOP function during RUN mode operation.

6. Communication program

Bit No.	Representative contents	Segment of bit	Detailed contents	Description
S[26]	_SYS_STATE	BIT 10	Forced input	Indicates that forced On/Off for input contact is being executed.
S[27]		BIT 11	Forced output	Indicates that forced On/Off for output contact is being executed.
S[28]		BIT 12	Stop by ESTOP function	Immediately stops by ESTOP function during operation of RUN mode.
S[29]		BIT 13	No meaning	
S[30]		BIT 14	On monitoring	Indicates that external monitor for program and variable is being executed.
S[31]		BIT 15	Remote mode ON	Indication on operating in remote mode.

S[32]	_PADT_CNF	BIT 0	Local GMWIN connection	Bit which shows connection status of local GMWIN.
S[33]		BIT 1	Remote GMWIN connection	Bit which shows connection status of remote GMWIN.
S[34]		BIT 2	Remote communication connection	Bit which shows connection status of remote communication.
S[35]	_DOMAIN_ST	BIT 0	Basic parameter error	Flag which checks basic parameter and indicates the error.
S[36]		BIT 1	I/O parameter error	Flag which checks I/O configuration parameter and indicates the error.
S[37]		BIT 2	Program error	Flag which checks user-program and indicates the error.
S[38]		BIT 3	Access variable error	Flag which checks access variable and indicates the error.
S[39]		BIT 4	High speed link parameter error	Flag which checks <i>high speed link</i> parameter and indicates the error.

S[40]	_CPU_ER	BIT 0	CPU configuration error	Error flag which occurs when normal operation is impossible by self diagnosis error of CPU module, mounting different location from CPU mounting location in base, and multi CPU configuration error, and so on(For details, see _SYS_ERR).
S[41]	_IO_ER	BIT 1	Module type mismatch error	Representative flag which detects and indicates errors if I/O configuration parameter of each slot is different from configuration of actually mounted module, or if certain module is mounted in a slot in which it shouldn't be mounted(See _IO_TYER_N, _IOTYER[n]).
S[42]	_IO_TYER	BIT 2	Module mounting error	Representative flag which detects and indicates error when module configuration of each slot is changed during operation(See _IO_DEER_N, _IO_DEER[n]).
S[43]	_FUSE_ER	BIT 3	Fuse blowout error	Representative flag which detects and indicates error when fuse blowout occurs in a module that fuse is attached among modules of each slot(See _FUSE_ER_N, _FUSE_ER[n]).

Bit No.	Representative contents	Segment of bit	Detailed contents	Description
S[44]	_IO_RWER	BIT 4	I/O read/write error(failure)	Representative flag which indicates error when normal reading/writing of I/O module among module of each slot is impossible(See _IP_RWER_N, _IO_RWER[n]).
S[45]	_SP_IFER	BIT 5	Special/communication module interface error (failure)	Representative flag which indicates error when normal interface is impossible by initialization failure of special or communication module among modules of each slot or operation failure of module(See _IP_IFER_N, _IP_IFER[n]).
S[46]	_ANNUN_ER	BIT 6	Serious failure detection error of external device	Representative flag, which indicates failure detection occurrence when serious failure of external device is detected and written in _ANC_ERR[n] using user, program.
S[47]	Not available			
S[48]	_WD_ER	BIT 8	SCAN WATCH-DOG error	Error occurred when scan time of program exceeds SCAN WATCH-DOG TIME set by parameter.
S[49]	_CODE_ER	BIT 9	Program code error	Error occurred when invalid command is used during user program execution.
S[50]	_STACK_ER	BIT 10	STACK OVERFLOW error	Error that program stack exceeds normal area during program execution.
S[51]	_P_BCK_ER	BIT 11	Program error	Error that program memory is destroyed or execution is impossible by program error (See _DOMAIN_ST).
S[52]	_RTC_ERR	BIT 0	Warning RTC data error of system	Flag which indicates RTC data error.
S[53]	_D_BCK_ER	BIT 1	DataBACK_UP error	Flag, which indicates that normal hot or warm restart program execution is impossible and cold restart is executed because of data memory destruction by BACK_UP error. This can be used in initialization program. This is reset after initialization program is finished.
S[54]	_H_BCK_ER	BIT 2	Hot restart disable error	Flag, which indicates that hot restart time is exceeded or BACK_UP of operation data is not normally made when power failure is recovered during program operation and restart operation is executed according to parameter(warm or cold). This can be used in initialization program. This is reset after initialization program is finished.

6. Communication program

Bit No.	Representative contents	Segment of bit	Detailed contents	Description
S[55]	_AB_SD_ER	BIT 3	Abnormal shutdown	Flag which warns that operation error may be occurred in process of existing data area when warm restart program is executed with power on again after program is stopped by power cut-off during execution. This can be used in initialization program. This is reset after initialization program is finished. This is also indicated when program is stopped during execution by 'ESTOP' function.
S[56]	_TASK_ERR	BIT 4	Task crash (regular period, external task)	Flag which indicates task crash when execution of identical task is repeatedly requested during user program execution(For details, see _TC_BMAP[n], _TC_CNT[n]).
S[57]	_BAT_ERR	BIT 5	Battery error	Flag which detects and indicates that battery voltage for user program and data memory backup is specification or less.
S[58]	_ANNUN_WR	BIT 6	Slight failure detection of external device	Representative flag, which indicates failure detection when slight failure of external device is detected and written in _ANC_WB[n] by user, program.
S[59]	Not available			
S[60]	Not available			
S[61]	_HSPMT1_ER	BIT 8	High speed link 1 error	Representative flags that check error of each high speed link parameter when high speed link is enabled and high speed link execution is impossible. This is reset when high speed link is disabled.
S[62]	_HSPMT2_ER	BIT 9	High speed link 2 error	
S[63]	_HSPMT3_ER	BIT 10	High speed link 3 error	
S[64]	_HSPMT4_ER	BIT 11	High speed link 4 error	

6.3.7 Error received from communication module

This explains STATUS code when error bit of *function block* is set to 'On' after *function block* is executed.

1) Received error from communication module

Error No. (Decimal)	Description
0	Normal (No error)
1	Physical layer error of link side(Tx/Rx impossible) – Cause of self error and other station's power off, other station No. writing error, and failure, etc.
3	There is no identifier of <i>function block</i> to be received in communication channel. – Value not used in LGIS.
4	Data type mismatch
5	Reset received from other station – Value not used in LGIS.
6	Communication command of other station not ready(Receiver not enabled) – Value not used in LGIS.
7	Device state of remote station in wrong state – Value not used in LGIS.
8	Access denied to remote object
9	Communication commands of other station unable to process due to receiver overrun – Value not used in LGIS.
10	Time out for response waiting – When response has not been received from other station within a given time.
11	Structure error
12	Abort(Local/Remote) – Disconnected by serious error
13	Reject(Local/Remote) – Type unfitted to MMS, error caused by noise.
14	Communication channel setting error(Connect/Disconnect) – Error related to logical communication channel setting required during communication with service for PI/DOMAIN/GEN and other communication module(for Mini-MAP only)
15	High speed communication and connection service error
33	Cannot find variable identifier – Not identified in the range of access variable
34	Address error – Error of structure and range specified in specifications of communication module
50	Response error – When response not received as required or other station's CPU error
113	Object access unsupported – Out of VMD specific and symbolic address or exceeded max. value of data length
187	Received via another error code than specified code(Other company's communication code value) – Receiving another error code value than specified.

6. Communication program

2) STATUS values indicated in CPU

(1) Error processed within *function block*

Error No. (Decimal)	Description
16	When position of computer communication module is wrongly specified.
17	Initialization error of communication module mounted in SLOT_NO
18	Input parameter setting error
19	Variable length error
20	Wrong response receiving from other station
21	When no response received from computer communication module (Out of waiting time - Time out)

(2) Status error related to remote(FSM) *function block*

Error No. (Decimal)	Description
128	FSM power error
129	BASE(Rack) No. error
130	Slot No. error
131	Module information error
132	Data range error(Invalid range)
133	Data type mismatch
136	Access failure(BUS access error)
137	Another error than specified code

6.3.8 Access variable registration

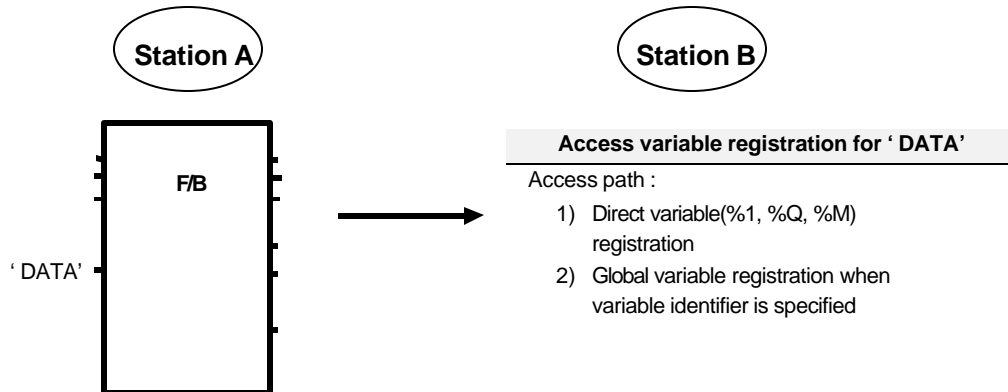

Fig. 6.3.8(A) Concept drawing of access variable setting

Direct variable and variable identifier can be used when user specifies the variable(VAR1~4) for data reading and writing during communication with other station. Direct variable can access memory, input, and output area, and only BOOL, BYTE, WORD, DWORD, and LWORD data type is possible. If variable identifier is used, different from direct variable, access for all data types are possible. But service is possible by accessing after variable identifier is registered in access variable area of other station. Namely, if variable identifier to be transmitted is 'DATA', receiving station should define which area is to be used for variable 'DATA'. At this time, there are two methods for location specification.

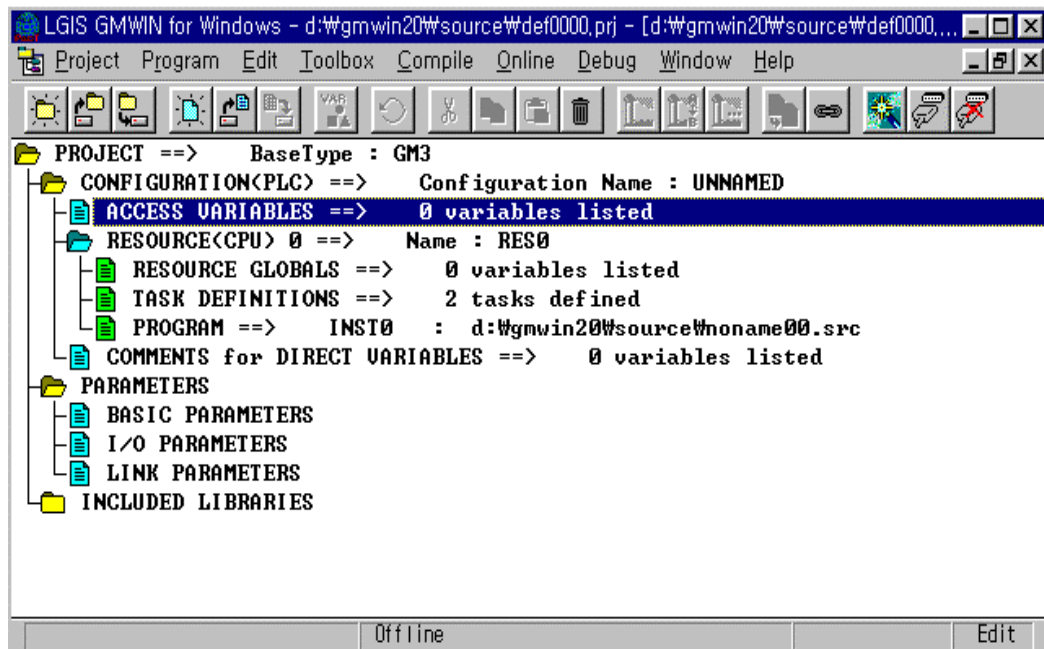

Fig. 6.3.8(B) Registration screen of access variable

6. Communication program

1) Direct variable area(%I, %Q, %M) setting for access path name

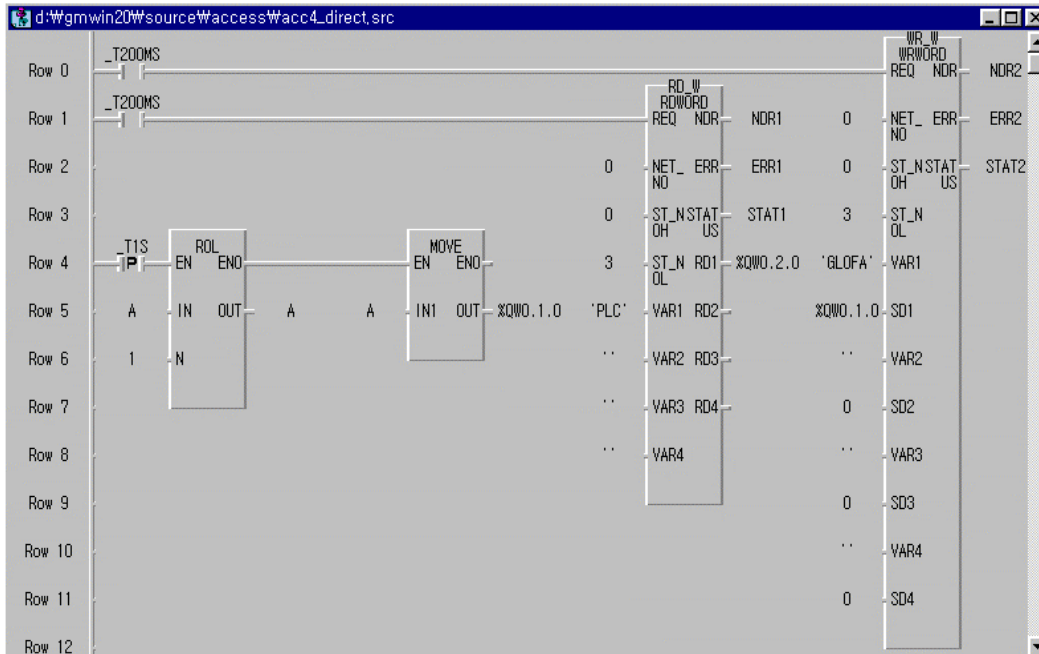

Fig. 6.3.8(C) Example of station A program

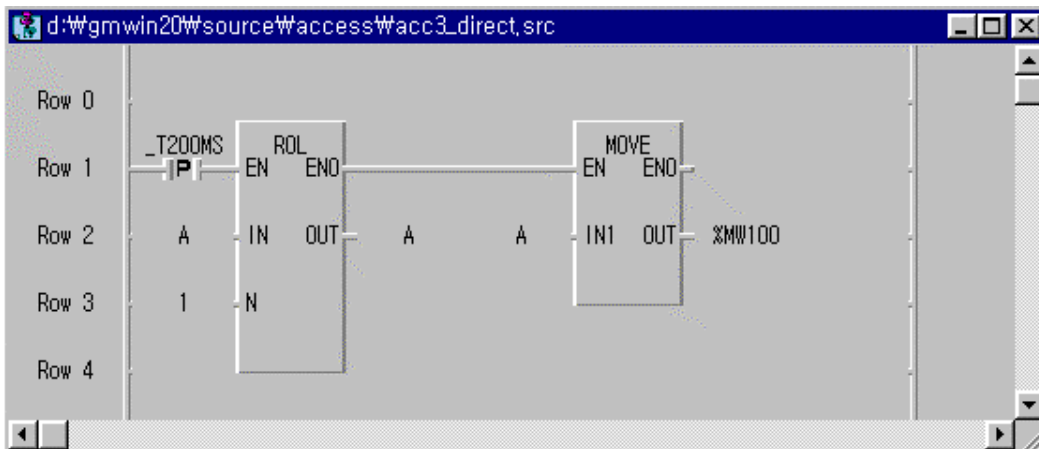

Fig. 6.3.8(D) Example of station B program

When station A reads variable 'PLC' or writes variable 'GLOFA' for station B, station B should define the type of data 'PLC' and 'GLOFA', and the location of variable 'PLC' and 'GLOFA'. To specify, enter PLC for access variable name in 'Access variable add/edit list' as Fig. 6.3.8(E) (Access variable name in 'Access variable add/edit' box is variable identifier, so user should register a name to be used for variable identifier in *function block* of other station. Namely, access is possible when the variable name is the same as variable identifier used in VAR1~4 which is input of *function block* used in program of other station) and enter %MW100 for access path, then variable PLC is allocated in the memory location of %MW100.

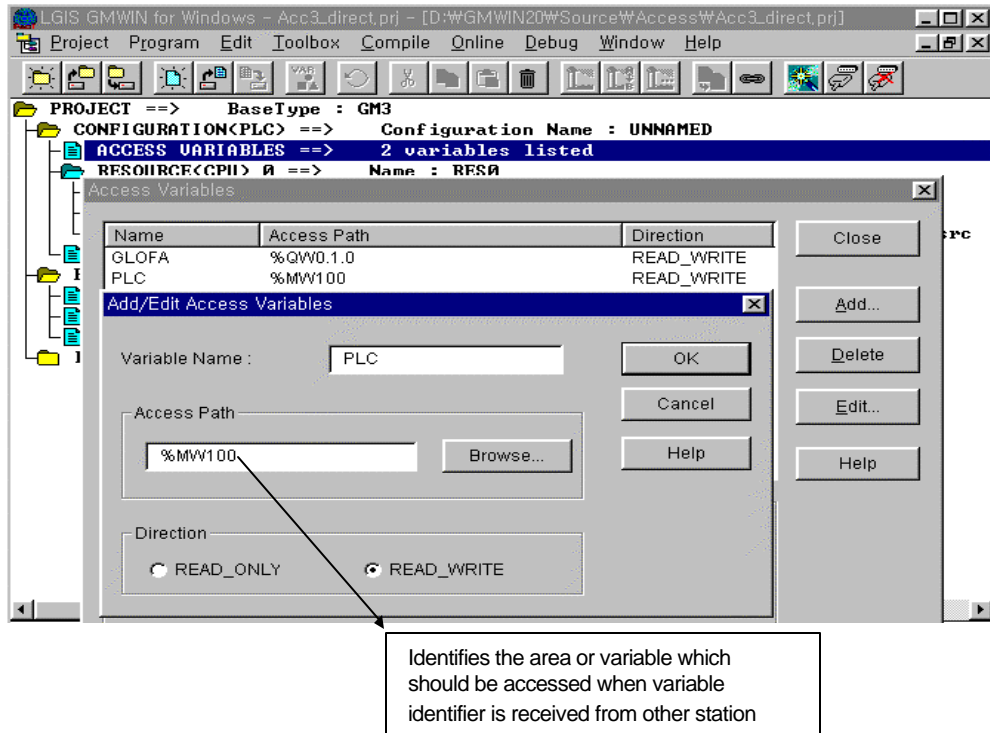

Fig. 6.3.8(E) Access variable registration

Therefore, To read 'PLC' of station B from station A is the same as to read data of %MW100 in station B. Specify path for variable 'GLOFA' as shown above(Data type used in transmitting station should be the same as that of receiving station).

2) Setting of variable identifier for access path

To use variable identifier that access path is not direct variable, user should register this variable identifier in 'Resource global variable' items, select 'Add' 'Search' in 'Access variable registration', and register global variable previously registered. Here explains example of global variable and access variable registration, when access variable is GLOFA and path of GLOFA variable is PLC_DATA.

Specify global variable registration as Fig. 6.3.8(F). Define data type the same as the type used in other station and specify memory allocation as automatic or user-defined (Ex. %MW100 for word type memory). If global variable registration is finished, click OK to escape and select 'Access variable' and click 'Search' in 'Path list', then list for global variable previously specified is displayed as Fig. 6.3.8(G), and select appropriate global variable and click OK.

6. Communication program

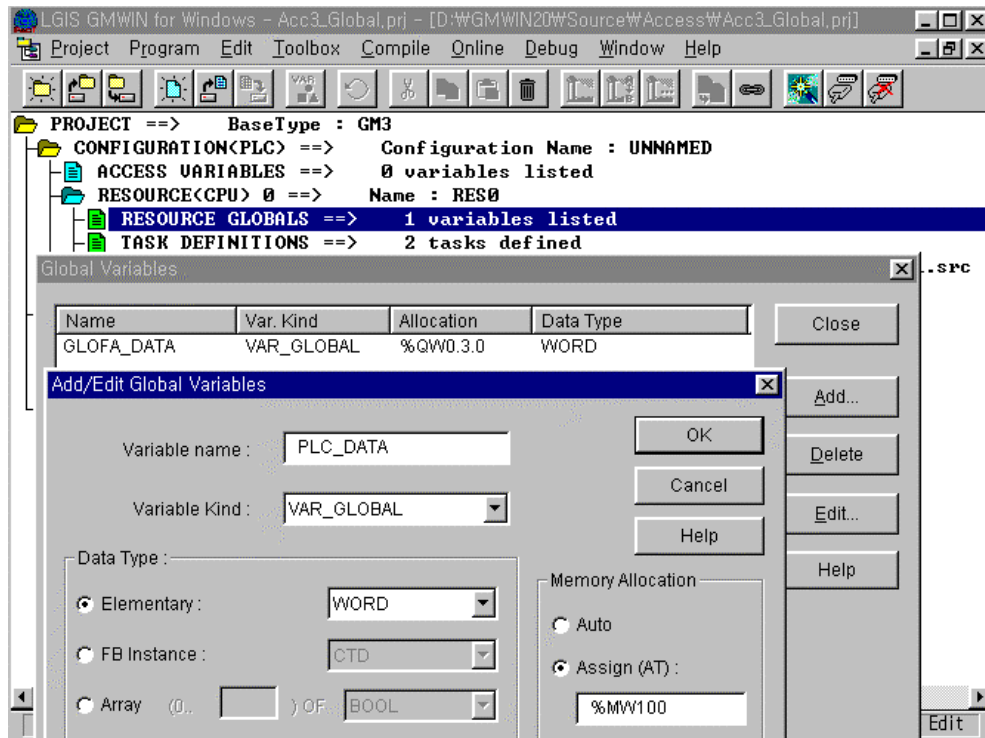

Fig. 6.3.8(F) Global variable registration

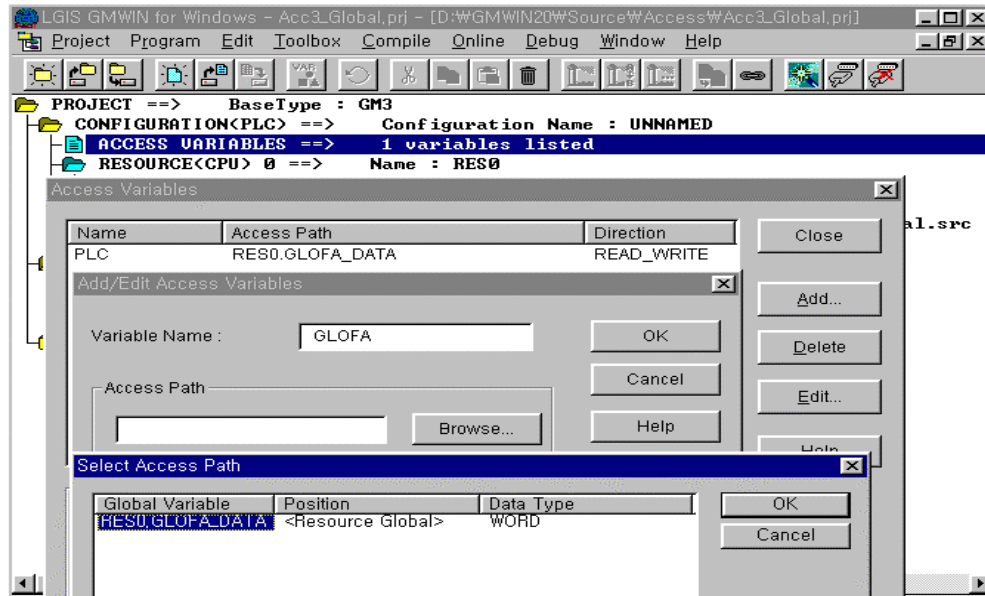

Fig. 6.3.8(G) Global variable selection

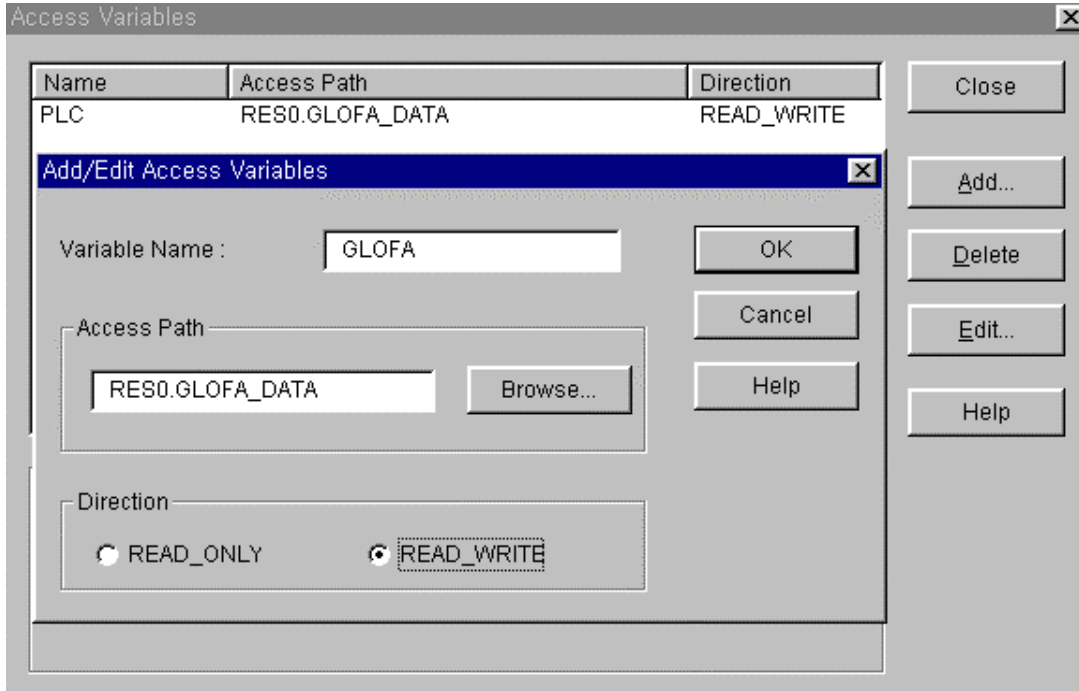

Fig. 6.3.8(H) Access path selection

Variable shown in 'Access variable list' as Fig. 6.3.8(H) shows path specification to access global variable, and default resource name of 'RES0' should be used for global variable specification.

Number of access variable can be registered up to Max. 128 for GM1 and GM2 and 64 for GM3, GM4, GM5 and GM6.

In 'Access enable' item, select 'Read' to allow reading of appropriate area through variable identifier from other station, and select 'Read and write' to allow all of reading and writing.

In RES0.PLC_DATA of access path registration, RES0 means resource name(GM1 can use 4 CPU, so RES0, 1, 2, and 3 can be used. User may either use 4 GM1 CPU or use RES0 for resource name of GM2, GM3, GM4, GM5 and GM6 : default is RES0).

6.4 GMWIN remote connection service

6.4.1 Introduction

This function enables remote control of program preparation, download of user program, program debugging, and monitor in network system that PLCs are connected each other in Fnet or Mnet, without moving physical connection of GMWIN. Especially, user can access each device at one location without moving location when devices connected in network are apart distantly. GMWIN communication service generates following path to accomplish the goal.

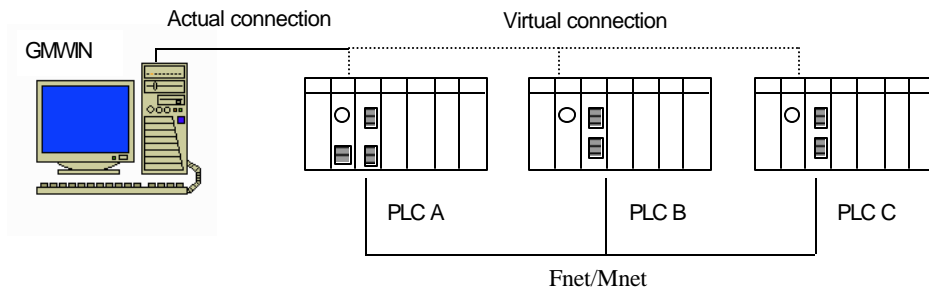

Fig. 6.4.1 Ex. of GMWIN remote connection network

In GMWIN of Fig. 6.4.1, let us suppose a network that RS-232C cable is connected to CPU module of PLC A station and PLC A, PLC B, and PLC C are connected each other with Fnet or Mnet. To access PLC C, choose communication module station number of PLC C (other station number to connect) and sbt number of PLC A (slot number that communication module is mounted in PLC A which currently connected with GMWIN) at Remote 1/ Remote 2 connection in Project → Option... → Connect option menu. Then logical connection by RS-232C and Fnet/Mnet is made. This state is identical with the connection that RS-232C cable is connected to PLC C station, and functions of program preparation, download, debugging, and monitor are possible in PLC C as in PLC A. This communication service of GMWIN can be used to connect to the content of remote PLC location, and this can be used for maintenance and repair of PLC system.

6.4.2 GMWIN remote connection

Remote connection between PLCs connected with Fnet and Mnet can be connected with remote 1 or remote 2.

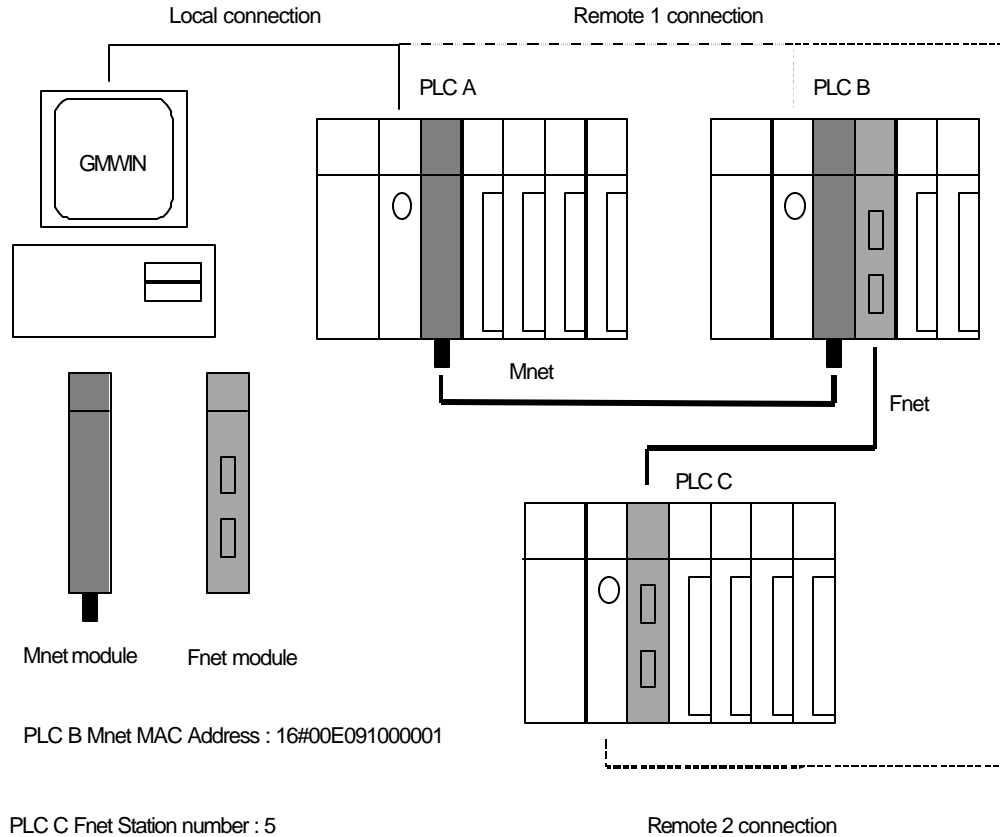
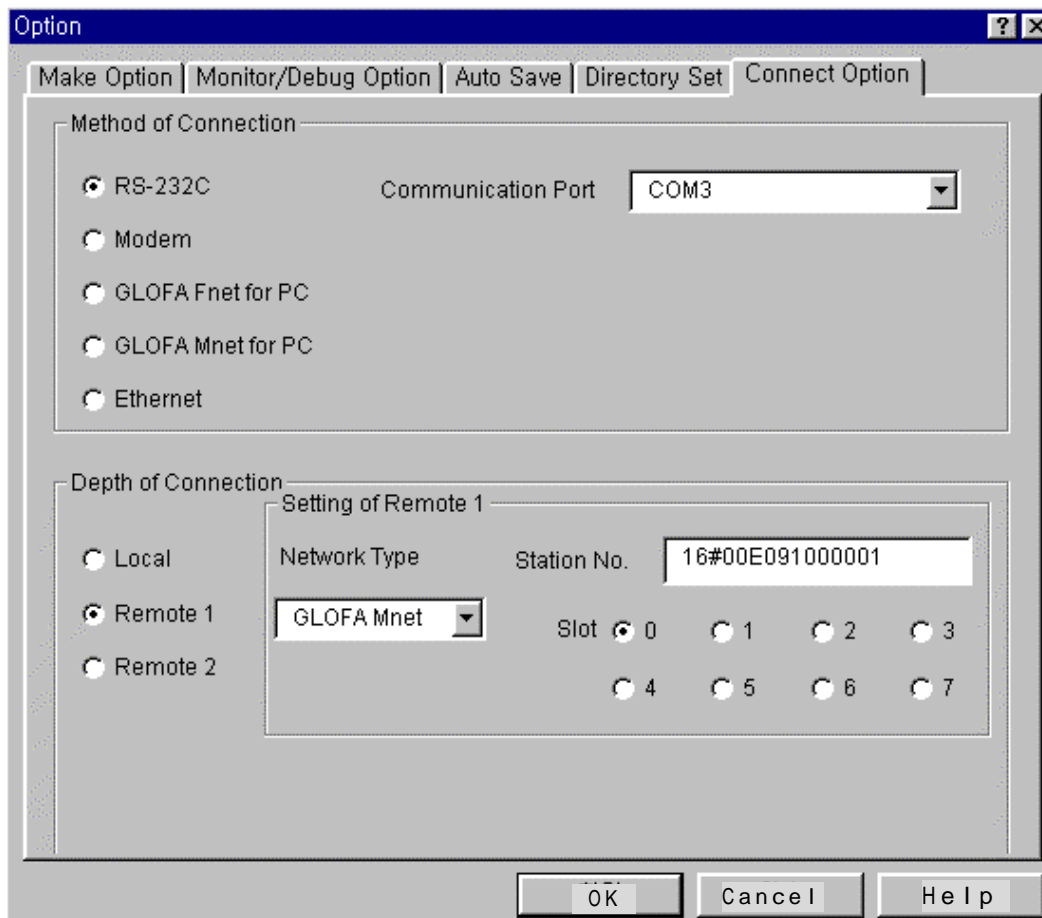

Fig. 6.4.2 Remote 1 , 2 connection

Fig. 6.4.2 shows the connection example of remote 1(PLC A, PLC B) and remote 2(PLC C) in a system configured with two network.

Remote 1 connection : GMWIN should be in off-line state for remote 1 connection. In this state, choose Project → Option...→ Connect option menu from upper menu of program, and choose Remote 1 in connection level, then following screen will be displayed :



Network type setting :

Choose type according to net work that remote 1 connection is made. In Fig. 6.4.2, choose GLOFA Mnet because remote 1 connection is connected with Mnet.

Station number setting :

Specify station number of communication module mounted in PLC which makes remote 1 connection (Module number of PLC B, 16#00E091000001, in Fig. 6.4.2). Station number is written on the case of module for GLOFA Mnet, and the value that is set on station number switch in front of module can be used for GLOFA Fnet. When user enters station number, the type of '16#00E09100****' is used for hexadecimal, and decimal figure without '16#' is used for decimal.

Slot number setting :

Select slot number of communication module mounted in PLC of self station, which makes remote 1 connection.

Click OK to escape from option screen when setting is finished, and select On-line → Connection.

If remote 1 connection is normally made, following message is displayed :



If connection is failed, following message is displayed :



(Communication line error / internal protocol error)



(When setting value of remote connection is not proper)

If PLC that remote 1 connection is made is different from CPU type of project currently opened, following message is displayed and only restricted On-line menu can be selected.



The state that remote 1 connection is finished is state of logical connection, and this is the same as RS-232C cable is connected. All of On-line menu can be used(But this is not possible if PLC different from CPU type of project currently opened). Operation is finished with remote 1 connection and connection is cut off, then following message is displayed :

6. Communication program



Remote 2 connection :

Remote 2 connection is made through following sequence GMWIN Mnet of PLC A Mnet of PLC B Fnet of PLC B Fnet module of PLC C.

GMWIN should be in off-line state for remote 2 connection, and in this state, choose Project → Option ... → Connect option menu from upper menu of program, and choose and set Remote 2 in connection level.

Network type setting :

Choose type according to network that remote 1 and 2 connection are made. Network type of remote 1 and 2 connection can be different.

Station number setting :

Specify each station number of remote 1 connection and remote 2 connection. Enter 16#00E091000001 of PLC B station number for remote 1 connection, and enter station number 5 of PLC C for remote 2 connection. Station number is written on the case of module for GLOFA Mnet, and the value that is set on station number switch in front of module can be used for GLOFA Fnet. When user enters station number, the type of '16#?????' is used for hexadecimal, and decimal figure without '16#' is used for decimal.

Slot number setting :

For remote 1 connection, enter slot number 0 that communication module of PLC A is mounted for connection of PLC A PLC B and slot number 1 that communication module of PLC B is mounted for remote 2 connection of PLC B PLC C.

If user sets network type, station number, and slot number with value explained above, and clicks OK of dialogue box, and performs On-line connection, then remote 2 connection is made and following message is displayed.



In this case, remote 2 connection is finished. This is status of logical connection and this is the same as the connection that RS232C cable is connected to PLC C. User can use all of On-line menu. Operation is finished with remote 2 connection and connection is cut off, then following message is displayed :



If user cut off remote 1 connection, then connection is finished.



Next table shows relations connectable between connection requesting device(Client) that RS-232C cable is connected in GMWIN communication service and connecting device(Server) which connects it according to its request.

6. Communication program

Table 6.4.2 Relation of roles between client and server of GMWIN

Client \ Server	PC-module (GMWIN)	GM1	GM2	GM3	GM4	GM5	GM3 remote I/O	GM4 remote I/O
PC-module (GMWIN)	X	O	O	O	O	O	O	O
GM1	X	O	O	O	O	O	O	O
GM2	X	O	O	O	O	O	O	O
GM3	X	O	O	O	O	O	O	O
GM4	X	O	O	O	O	O	O	O
GM5	X	O	O	O	O	O	O	O
GM6	X	O	O	O	O	O	O	O
GM3 remote I/O	X	O	O	O	O	O	O	O
GM4 remote I/O	X	X	X	X	X	X	X	X

There is connector for RS-232C connection in GM3 remote I/O. Namely, GMWIN can be connected to PLC of GM1 ~ GM5 from GM3 remote I/O station (This is not available in GM4 remote).

If GMWIN is used for PC module(G0L-FUEA for Fnet, G0L-MUEA for Mnet), user should specify as following in option menu of GMWIN project, according to network to be used.

For port and memory setting of PC module, see Appendix A3

Caution when remote 1 and 2 connection in GMWIN

- 1) If currently opened project in GMWIN is different from CPU type connected with remote 1 and 2, following items are not supported:
 - (1) Writing of program and each parameter
 - (2) Reading of program and each parameter
 - (3) Monitor
 - (4) Flash memory
 - (5) Link enable setting
 - (6) I/O information
 - (7) Forced I/O information
 - (8) Mnet parameter, Mnet information
 - (9) I/O skip

- 2) When GMWIN is programmed by connecting remote 1 and 2, user should open corresponding project of station to be connected and perform remote connection.

- 3) If remote connection is made with GM3/GM4 remote I/O, following items are not performed :
 - (1) Writing of program and each parameter
 - (2) Reading of program and each parameter
 - (3) Operation performed with direct relation to program
 - * Time chart monitor of monitor
 - * Link parameter of monitor
 - * *High speed link* monitor
 - * Forced I/O information
 - * Link enable setting
 - * Flash memory
 - * Link information
 - * Mode conversion
 - (4) Flash memory
 - (5) Link enable setting
 - (6) Mnet parameter, Mnet information
 - (7) I/O skip

- 4) Remote connection is supported up to remote 2. Remote connection of more than 2 is impossible.

6.4.3 Remote module information

If connection is made with remote module by local or remote 1 or 2 connection, user can see entire information of remote module. If user choose PLC information → System information in On-line menu, following screen is displayed :

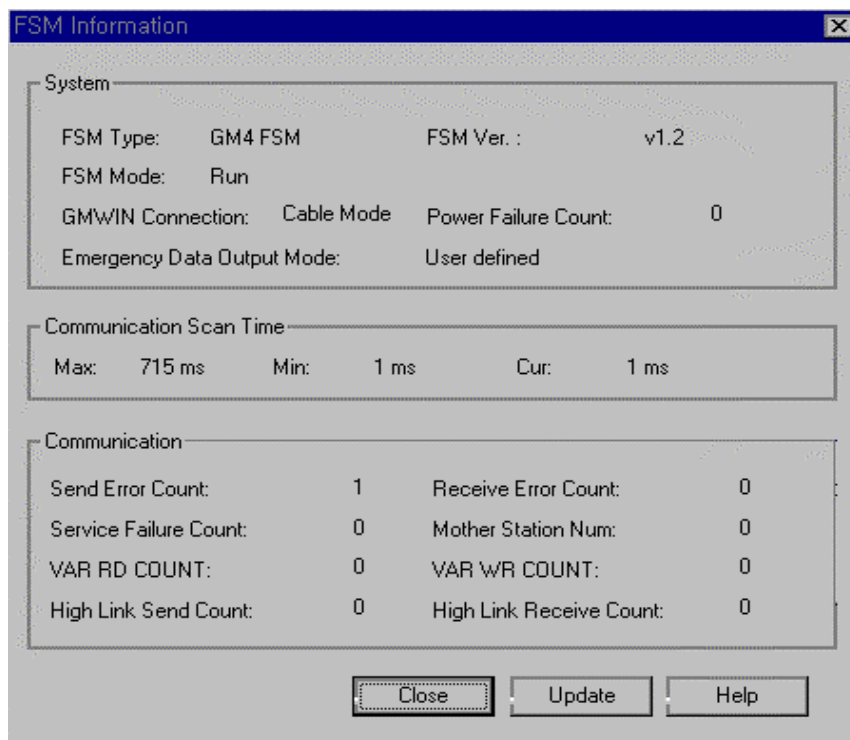

PLCversion : O/S version number of remote module station.

PLCmode : Operation status of remote module station (RUN / STOP).

RUN : Normal operation.

STOP : I/O module error, self diagnosis error, and power error.

GMWINconnection status :

Remote : GMWIN remote connection from other station to remote module station.

Local : Remote connection from remote module station to other station.

Count of power cut off : Count of instantaneous power failure.

Emergency data output mode : Sets output data type when communication is impossible.

Latch : Maintains current output data.

User setting : Outputs the value set in emergency data.

Communication scan time : Time that token circulates network once.

Count of Transmission/Receive error :

Count of frame error that transmitted from communication cable during communication. If a lot of error is occurred, this means that communication line has problem. So check the communication line.

Count of service error:

This is increased when other station sends NAC response during execution of *function block* service.

Master station setting number :

This is master station number of PLC, which transmits and receives data with remote I/O station.

VAR_RD_CNT / VAR_WR_CNT :

When *function block* service is executed, VAR_RD_CNT is increased for RD service and VAR_WR_CNT is increased for WR service.

Transmission/Receive Count of high speed link :

High speed link receive count is increased if *high speed link* data is received, and *high speed link* transmission count is increased if *high speed link* data is transmitted.

6.5 Function block service for FSM(Fnet Slave Module)

Fnet slave module is remote I/O control device that has communication function and I/O control function of PLC CPU. This doesn't have program execution capability, but this module is used to control remote I/O of CPU through communication. This module supports communication function of *high speed link* service, *function block* service, and remote connection service, and the others. This chapter explains slave control method using *function block* service.

6.5.1 Function blocks of special slave module

Special module can be mounted in slave, and mountable special modules are D/A conversion module, A/D conversion module, temperature conversion module, and high speed counter module, and types of mountable module are shown in Table 8.1.2 of Chap. 8 Installation and testing operation. Special module *function block* of slave is the *function block* to control special module mounted in slave. Values of NET_NO and ST_NO for input, and values of ERR and NDR for output are added to existing special *function block*. Fig. 6.5.1(A) explains the difference between A/D initialization *function block* of CPU and A/D initialization *function block* of slave by using initialization *function block* of A/D conversion module.

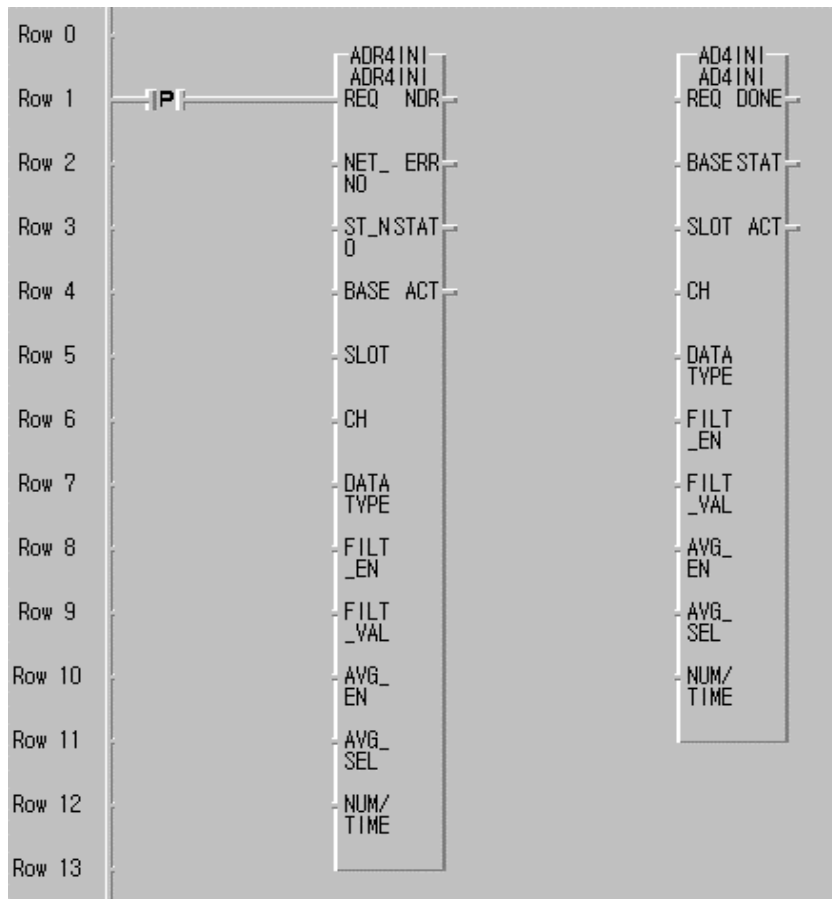

(A) Special module function block of FSM (B) Special module function block of CPU

Fig. 6.5.1(A) Ex. of A/D initialization function block

In Fig. 6.5.1(A), special module *function block* of CPU means *function block* to initialize special module when special module is mounted in CPU, and special module *function block* of slave means *function block* of slave to initialize special module mounted in slave. Added I/Os in slave *function block* as shown in figure are communication I/Os to communicate with slave, and Table 6.5.1(A) explains I/O contents that are added in slave *function block* and I/O that is commonly used in slave *function block*.

Table 6.5.1(A) I/O of special module *function block* for slave

Name	Contents	Segments
REQ (Input)	Input contact, which operates <i>function block</i> . <i>Function block</i> is operated when input value is changed from '0' to '1'.	Rising edge (Bool)
NET_NO (Input)	Slot No. of communication module to execute <i>function block</i> service among communication module mounted in PLC of self station. I.e., mounting location of master in slave.	0 ~ 7
ST_NO (Input)	Station number of other station. Sets station number of slave that special module is mounted.	0 ~ 63
NDR (Output)	Operation result of <i>function block</i> . This is set to 'On' when operation is normally executed, and maintains 'On' until next scan is executed.	On/Off
ERR (Output)	Operation result of <i>function block</i> . On when error occurred.	On/Off
BASE (Input)	Input that sets mounting location of special module mounted in slave. This means base number that the module is mounted.	0 ~ 3
SLOT (Input)	Input that sets mounting location of special module mounted in slave. This means slot number that the module is mounted.	0 ~ 7

I/Os that is not explained in Table 6.5.1(A) are different I/O variable according to special module, and they have the same I/O characteristics as *function block* of special module used.

Refer to user's manual for each special module.

6. Communication program

Table 6.5.1(B) Types of special module function block in slave

CPU type[Remark]		GM1, GM2	GM3	GM4	GM5	GM6	Remark
ADRxINI (x = 2, 4)	ADR2INI	X	X	O	X	X	4 Channel
	ADR4INI	O	O	X	X	X	16 Channel
ADRxRD (x = 2, 4)	ADR2RD	X	X	O	X	X	4 Channel
	ADR4RD	O	O	X	X	X	16 Channel
DARxINI (x = 1, 4)	DAR1INI	X	X	O	X	X	2 Channel
	DAR4INI	O	O	X	X	X	16 Channel
DARxWR (x = 1, 4)	DAR1WR	X	X	O	X	X	2 Channel
	DAR4WR	O	O	X	X	X	16 Channel
HSCRx_RD (x = 0, 1)	HSCR0RD	X	X	O	X	X	1 Channel
	HSCR1RD	O	O	X	X	X	2 Channel
HSCRx_SET (x = 0, 1)	HSCR0SET	X	X	O	X	X	1 Channel
	HSCR1SET	O	O	X	X	X	2 Channel
HSCRx_WR (x = 0, 1)	HSCR0WR	X	X	O	X	X	1 Channel
	HSCR1WR	O	O	X	X	X	2 Channel
RTDxINI (x = 2, 3)	RTDR2INI	X	X	O	X	X	4 Channel
	RTDR3INI	O	O	X	X	X	8 Channel
RTDxRD (x = 2, 3)	RTDR2RD	X	X	O	X	X	4 Channel
	RTDR3RD	O	O	X	X	X	8 Channel
TCRxINI (x = 2, 4)	TCR2INI	X	X	O	X	X	4 Channel
	TCR4INI	O	O	X	X	X	16 Channel
TCRxRD (x = 2, 4)	TCR2RD	X	X	O	X	X	4 Channel
	TCR4RD	O	O	X	X	X	16 Channel

Remark

1. CPU type indicates the CPU type that can use special module *function block* in slave, and GM5 PLC can't access special module of slave as shown in Table.
2. In *function block* name, 'R' of next to special module, as shown in ADRxINI and ADRxRD, indicates remote(slave) block, and 'x' indicates channel number of special module and channel number is determined by 2^x .

How to use

1) Master station setting

Slave doesn't have user program of itself, and it is remote I/O device using user program of PLC CPU and communication function. Slaves transmit and receive data by one master station, so master station of slave should be set before system configuration. The same value as master station number should be set for master station of slave using decimal switch located inside of slave, and this master station is operated as a master station when *high speed link* and *access function block* service of special module are executed.

Table 6.5.1(C) shows whether slave service is operated or not according to PLC mode of master station. Slave is operated according to mode of master station as shown in Table, so special module access should be made by master station because abnormal operation may occur if special module access of slave is made by other than master station.

Table 6.5.1(C) Slave operation according to PLC mode of master station

CPU MODE	<i>High speed link of slave</i> [Remark]	Special module access of slave	I/O refresh
RUN	○	○	○
STOP	○	X	○
PAUSE	○	○	○
DEBUG	○	○	○

Remark

Operation of *high speed link* is determined according to enabling link of master station.

2) Program

Communication function of master and slave, different from PLC, is used for special module control through slave. Therefore, special module *function block* program of slave needs, different from access program of special module *function block* of PLC, program preparation which reliability of communication is considered.

Fig. 6.5.1(B) is system configuration drawing which suppose that special module of slave two station is accessed through one master. In the figure, A/D input module(4 channel) is mounted in slot 1 of slave station 3, and D/A output module(2 channel) is mounted in slot 2 of slave station 4.

6. Communication program

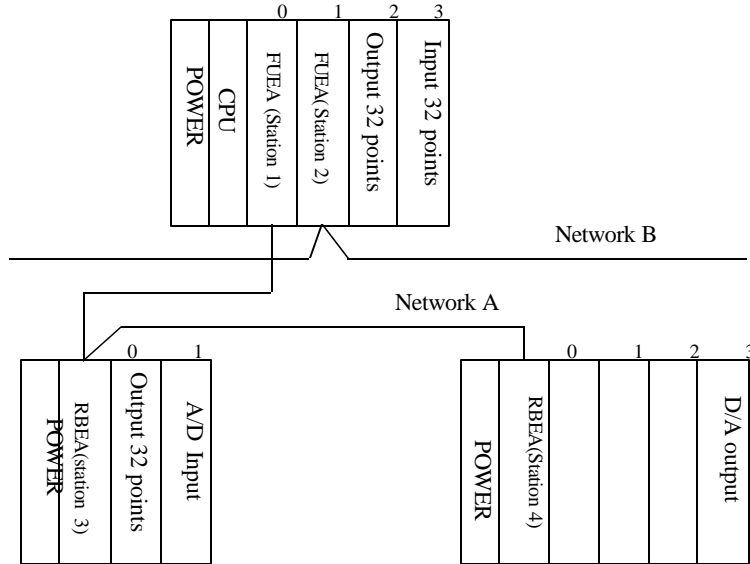
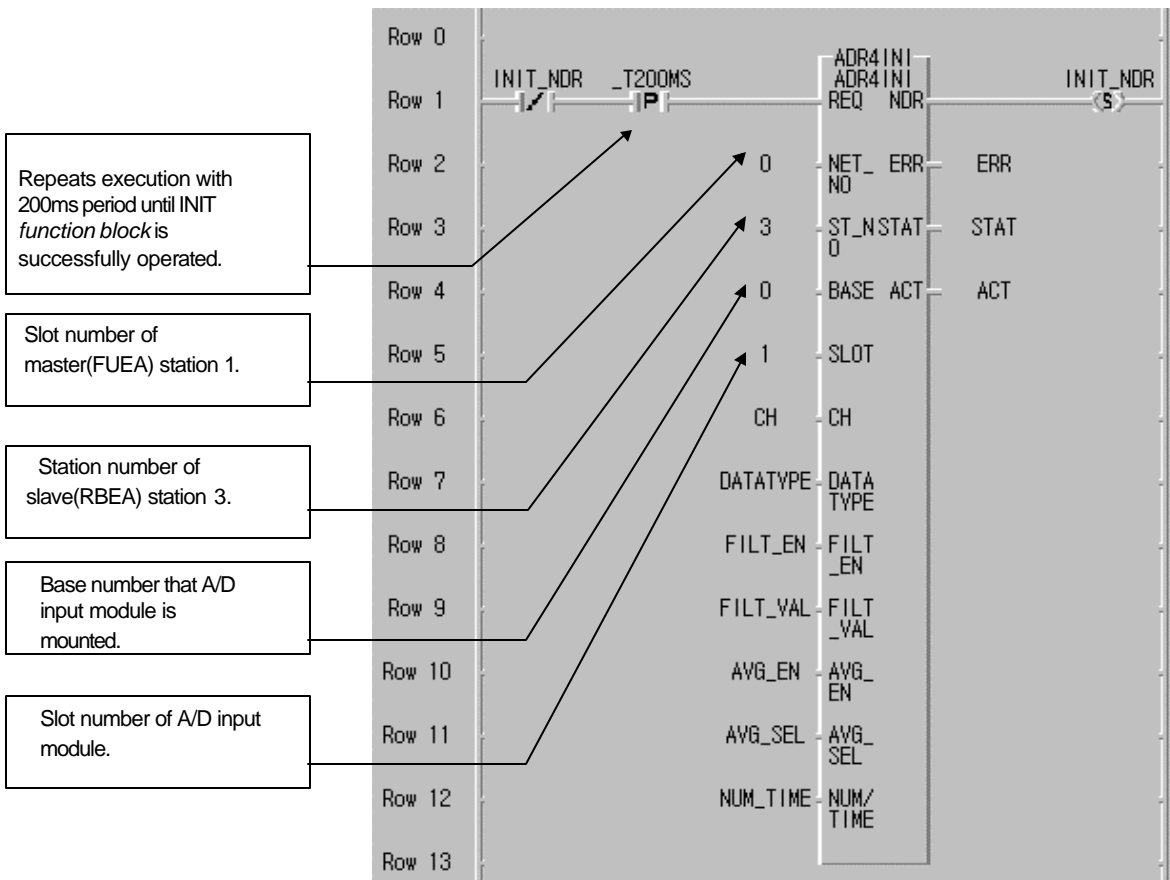

Fig. 6.5.1(B) Configuration of special module access system for slave

To access special module of slave in a system as shown in Fig. 6.5.1(B), master station should be set by adjusting master station setting switches of slave 3 and 4 station to station 1. After master station setting is finished, *function block* service program of slave special module should be prepared using GMWIN program. Fig. 6.5.1(C) and Fig. 6.5.1(D) show example of program preparation.



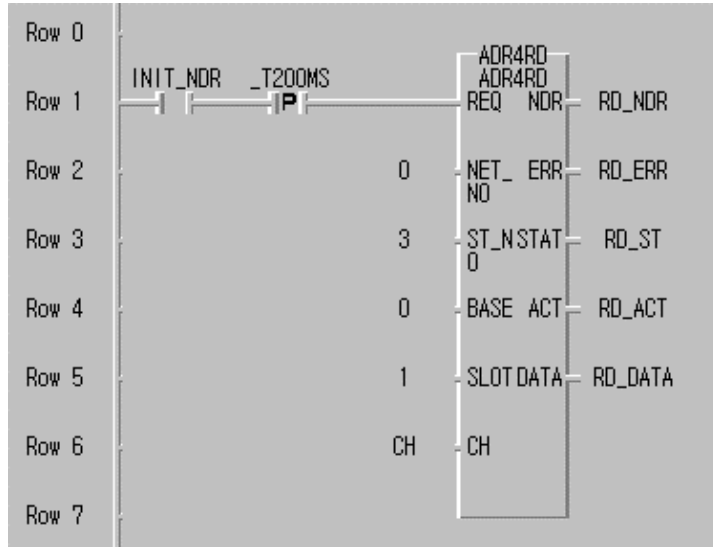
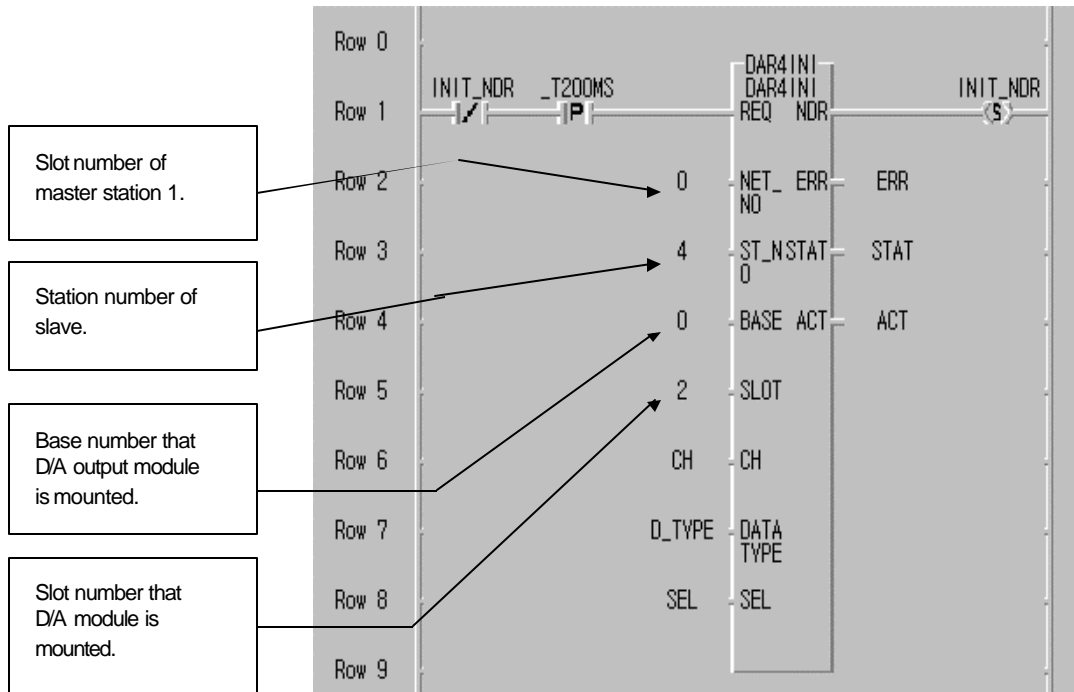

Fig. 6.5.1(C) Ex. of A/D input access program for slave

In Fig., AD_INIT function block is repeatedly operated with 200ms period until NDR is set to 'On', because initialization of special module, different from function block of CPU, may not be finished within 1 scan in slave (Because power of slave is supplied late or error is occurred by the problem of communication line). Therefore, program should be prepared to execute next operation after execution result of function block is checked, using NDR output contact as shown in example. This is identically applied to other special module access program.



6. Communication program

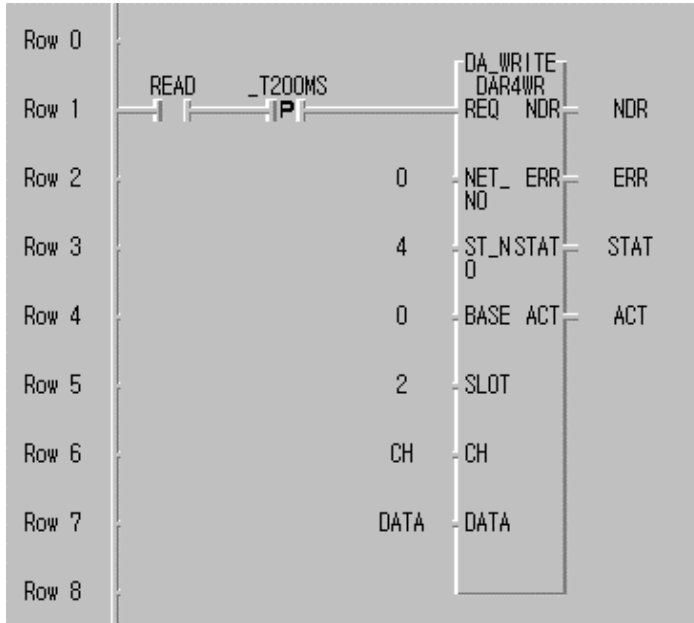

Fig. 6.5.1(D) Ex. of D/A output access program for slave

Above figure is D/A output module access program. In figure, initialization *function block* is repeatedly executed with 200ms period until NDR contact is set to 'On', and ST_NO, BASE, and SLOT number are set to location of D/A module and station number of slave 4.

3) STATUS information

Execution result of special *function block* using slave module is indicated by output contact of NDR and ERR. If result of *function block* execution is normal, NDR output is set to 'On' and ERR output is set to 'Off'. If result of *function block* execution is abnormal, ERR output is set to 'On' and NDR output is set to 'Off'. At this time, error type is indicated through output value of STAT(For details about access error of slave special module, see Appendix A3).

6.5.2 Function block of Reading / Writing in slave module

Slave supports *function block* service explained Chap. 6.3 of this user's manual, and special area like I/O area and emergency data area of slave can be read and written using *function block* service. Slave, different from CPU, is a module operated without user program, so this can use part of CPU *function block*. Table 6.5.2(A) shows type of *function block* supported by slave.

Table 6.5.2(A) Function block type of slave

Function block type		Data type	Access area	Read / Write	Size
Standard type	RD_Bool	Bool	%1W0 ~ %1W127 (256 byte) %QW0 ~ %QW127 (256 byte)	Read	
	RD_Byte	Byte			
	RD_Word	Word			
	RD_DWord	Double Word			
	RD_Lword	Long Word		Write	
	WR_Bool	Bool			
	WR_Byte	Byte			
	WR_Word	Word			
	WR_DWord	Double Word			
	WR_Lword	Long Word			
RD_Block	Byte	Read	Max. 120 byte		
WR_Block	Byte	Write			
Reserved access variable type	_BASE0_DATA	Word Array	Emergency output data of BASE 0	Read/Write enable	64 byte for 1 BASE
	_BASE1_DATA	Word Array	Emergency output data of BASE 1		
	_BASE2_DATA	Word Array	Emergency output data of BASE 2		
	_BASE3_DATA	Word Array	Emergency output data of BASE 3		
	_CARD_INFO	Byte Array	Module information area	Read only	32 byte
	_FSM_FLAG	Word Array	Flag area of slave system	Read only	44 byte

In slave, different from CPU, user cannot register access variable. Therefore, using name is reserved as key word, and user can read and write appropriate area by entering reserved name like '_BASE0_DATA' and '_CARD_INFO' into VAR input of *function block* with string type. In Table 6.5.2(B), slave _FSM_Flag shows entire information of slave operation status and its size is totally 44 byte, and this can be read through GMWIN remote connection service or *function block* service explained in Chap. 6.5.2(B). Table 6.5.2(B) explains detailed contents of slave system flag.

6. Communication program

Table 6.5.2(B) Contents of slave system flag

Variable name (Key word)	Contents	Start address (Hexadecimal)	Data type	Size	Remark
_CPU_Type	Remote CPU Type	h0000	Word	2 Byte	
_VER_NUM	O/S Version Number	h0002	Word	2 Byte	
_SYS_STATE	System State	h0004	Word	2 Byte	
_FSMTXECNT	TX Error Count	h0006	Word	2 Byte	
_FSMRXECNT	RX Error Count	h0008	Word	2 Byte	
_FSMSVFCNT	Service Fail Count	h000A	Word	2 Byte	
_FSMScanMX	Max. Scan TIME	h000C	Word	2 Byte	
_FSMScanAV	Average Scan TIME	h000E	Word	2 Byte	
_FSMScanMI	Min. Scan TIME	h0010	Word	2 Byte	
_MOTHSTNO	Master station NO.	h0012	Word	2 Byte	
_FSMVCNT	Variable RD Count	h0014	Word	2 Byte	
_FSMWCNT	Variable WR Count	h0016	Word	2 Byte	
_FSMHSTXCNT	HS-Link TX Count	h0018	Word	2 Byte	
_FSMHSRXCNT	HS-Link RX Count	h001A	Word	2 Byte	
_AC_Fail_CNT	Power Fail Counter	h001C	Word	2 Byte	
_CNF_ER d0 : _CPU_ER d1 : _IO_TYER d2 : _IO_DEER d3 : _FUSE_ER d4 : _IO_RWER d5 : _IP_IFER d6 : _PWR_ERR	Representative flag CPU hardware error Module setting error Module mounting error Fuse disconnection error I/O access error I/P access error SUB power error	h001E	Word Byte 0 Byte 1 Byte 2 Byte 3 Byte 4 Byte 5 Byte 6	2 Byte	Byte information (d7 ~ d15 are reserved byte)
_IO_TYER_N	Module setting error	H0020	Word	2 Byte	
_IO_DEER_N	Mounting error	h0022	Word	2 Byte	
_FUSE_ER_N	Fuse error	h0024	Word	2 Byte	
_IO_RWER_N	I/O error	h0026	Word	2 Byte	
_IP_IFER_N	Special module error	h0028	Word	2 Byte	
_PADT_CNF d0 : local connection d1 : remote connection	GMWIN connection status	h002A	Byte	1 Byte	
_E_DATA_OPTION	Emergency data output type	h002B	Byte	1 Byte	0:Output latch 1:User defined

Slave read/write using *function block* can be executed by the same method as Chap. 6.3 *Function block* service, and see Chap. 6.3 for details.

6.6 Use of communication module flag

6.6.1 Types of flag

1) Flag which checks that this station is normally communicating with other station.

- (1) **_NETx_LIV[n]** (Range n=0 ~ 63 : station number of other station)
‘Alive information’ of other station. This shows that power of other station is normal and data is normally transmitted and received with other station through communication cable.
- (2) **_NETx_RST[n]**
Power recovery information of other station. When other station becomes down and recovered because of power failure or cable dismounting, this is set to ‘On’ and indicates that other station has recovered.

2) Flag that resets remote I/O module

- (1) **_FSM_RESET**
This resets all of special module and digital I/O module of the base that remote module is located. If user need to reset all output of FSM when emergency occurred, user can reset remote station by entering station number of appropriate remote station to **_FSM_ST_NO**, and setting **_FSMx_RESET** flag to ‘On’. This flag is level input, and they are reset while this flag is set to ‘On’.
- (2) **_FSM_IO_RESET**
This resets all digital I/O module except special module in the base that remote module is located. If user need to reset FSM digital output when emergency occurred, user can reset remote station by entering station number of appropriate remote station to **_FSM_ST_NO**, and setting **_FSMx_IO_RESET** flag to ‘On’. This flag is level input, and they are reset while this flag is set to ‘On’.

Remark

The character of ‘x’ used in flag is slot number that communication module(FMM) is mounted(range : 0~7).

6. Communication program

3) High speed link flag of instantaneous power failure recovery for remote module

(1) _FSMx_HS_RESET

If power failure of remote station is occurred and then power is recovered, link-trouble is set to 'On' to check recovered information and _HS_MODE is set to 'Off' (User can know instantaneous power failure of other station using this flag). At this time, *high speed link* is normally executed but _HS_MODE is not RUN state(On). Therefore, set _HS_MODE to RUN state(On) by setting _FSMx_HS_RESET to 'On'. To set this, enter station number of appropriate remote station into _FSMx_ST_NO, and set _FSMx_HS_RESET FLAG to 'On'. Then, _HS_MODE is set to '1' and link-trouble is set to 'Off'.

4) Flag that indicates other station number

_FSMx_RESET, _FSMx_IO_RESET, and _FSMx_HS_RESET are used to flag that specify remote station number. If station number is set to 255(16#FF), all remote stations that master station is set to self station are operated by _FSMx_RESET, _FSMx_IO_RESET, and _FSMx_HS_RESET.

6.6.2 Major flag types used in Fnet

Segments	Data type	Access allowance	Remark
_FSMx_ST_NO Range : 0 ~ 63 (If 255, specifies all station)	USINT	READ / WRITE	Flags for FSM
_FSMx_RESET	BOOL	READ / WRITE	
_FSMx_IO_RESET	BOOL	READ / WRITE	
_FSMx_HS_RESET	BOOL	READ / WRITE	
_NETx_LIV[n] (Range : n = 0 ~ 63)	USINT	READ ONLY	Flags for FSM and FMM
_NETx_RST[n] (Range : n = 0 ~ 63)	USINT	READ / WRITE	

6.6.3 How to use Flag in GMWIN

If user selects 'Flag' in variable list of GMWIN, following 'Flag list' screen is displayed, then user can select appropriate flag.

GMWIN screen for Flag list

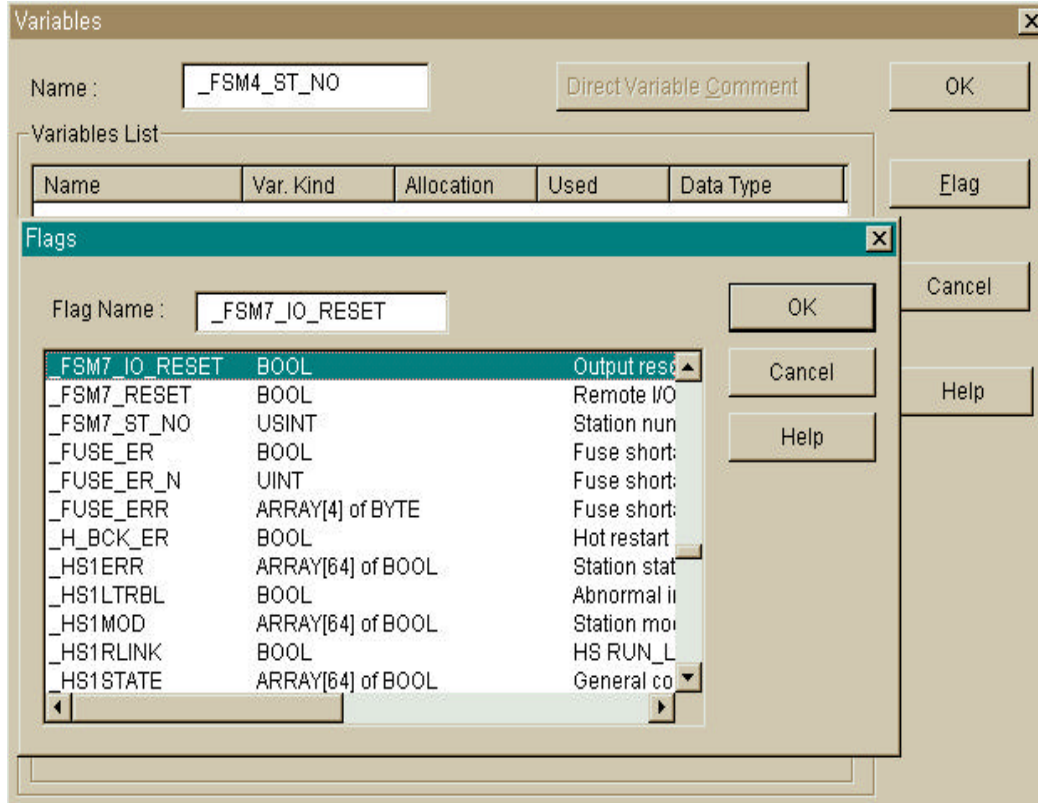

6. Communication program

6.6.4 Example of remote I/O reset program using _FSMx_RESET/_FSMx_IO_RESET

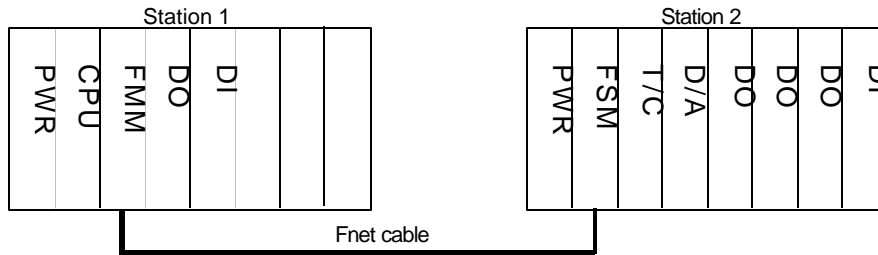

Fig. 6.6.4(A) Ex. of remote I/O system

Fig. 6.6.4(A) is configuration drawing of remote I/O system, which consist of PLC CPU, FMM, and FSM.

1) _FSM_IO_RESET flag application program

Fig. 6.6.4(B) explains a program that resets output of remote I/O using emergency input contact of PLC CPU.

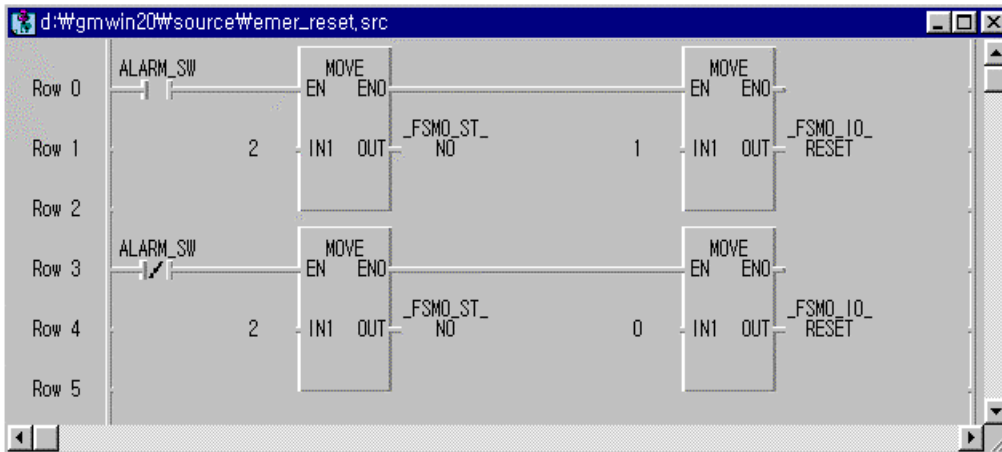

Fig. 6.6.4(B) Reset program of remote I/O output when emergency occurred

This is an example of program that clears digital output of remote I/O when emergency occurred. If user set ALARM_SW contact to 'On' in the figure, digital output of remote I/O can be cleared by entering remote I/O station number 2 into '_FSM0_ST_NO' flag and setting _FSM0_IO_RESET to '1'. At this time, '0' of _FSM0_ST_NO and _FSM0_IO_RESET means slot number which FMM is mounted, and output is cleared only in the FSM of station number specified by _FSM0_ST_NO. _FSM0_IO_RESET is level input, so output of remote I/O is cleared while it is set to '1', and remote I/O performs normal output when _FSM0_IO_RESET is set to '0'.

In the figure, if the value of ALARM_SW is set to 'Off', _FSM0_IO_RESET is '0' and normal output is performed. Digital output of _FSM0_IO_RESET is cleared, but special is not cleared.

Remark

If user enters '255' into '_FSM0_ST_NO', outputs of all remote I/O connected in FMM are simultaneously set to 'Off'.

2) Application program of _FSM_RESET flag

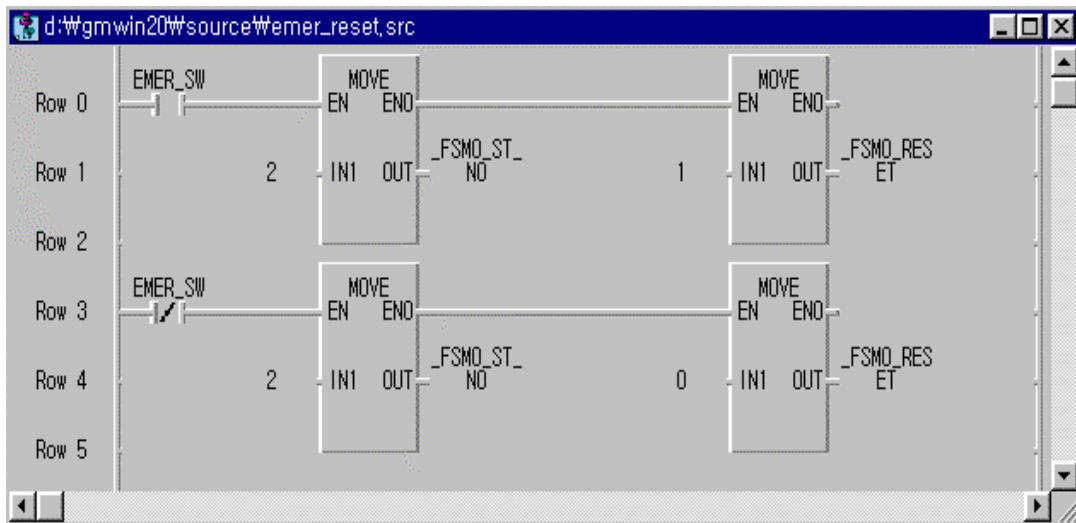

Fig. 6.6.4(C) Reset program of all output in appropriate remote station when emergency occurred

Fig. 6.6.4(C) is an example of program that simultaneously resets digital and special module output of remote I/O when EMER_SW contact of PLC CPU is set to 'On' in remote system of Fig. 6.6.4(A). To reset all I/O while it is set to 'On' as level input and to perform normal operation, special module initialization should be performed again using initialization *function block* of special module.

If _FSM_RESET is '1', only output is set to 'Off' and communication maintains normal operation.

Table 6.6.4 Remote I/O operation relation according to _FSMx_RESET/_FSMx_IO_RESET

Flag type	Communication service	Digital output	Special module output	Special module access
_FSMx_IO_RESET	Normal operation	Off	Normal output	Possible
_FSMx_RESET	Normal operation	Off	Reset	Impossible

6.6.5 Example of application program for restoring instant power off in the remote module

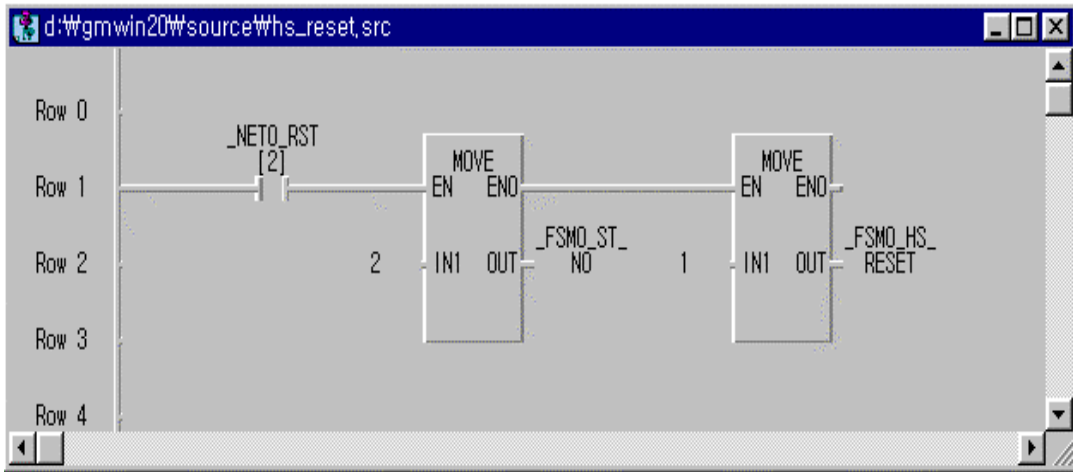

Fig. 6.6.5(A) Ex. of program using _FSMx_HS_RESET

Fig. 6.6.5(A) is an example of program that recovers *high speed link* flag to normal state when remote I/O station is recovered after power failure. In the figure, `_NETO_RST[2]` is a flag that is set to 'On' when power of station 2 becomes down and recovered during performing communication between communication module mounted in slot 0 and station 2 of other station(remote station). If power becomes down and recovered in remote station, `_HS_MODE` is set to 'Off' and link-trouble maintains 'On'. To clear this information, enter appropriate remote station into `_FSM0_ST_NO`, and set `_FSM0_HS_RESET` FLAG to 'On'. Then, `_HS_MODE` is set to '1' and link-trouble is set to 'Off'. If link-trouble maintains '1' after recovering power failure, this means that remote I/O has error, so user can handle it according to system configuration.

Remark

High speed link of remote I/O station performs normal operation even if link trouble is set to 'On'.

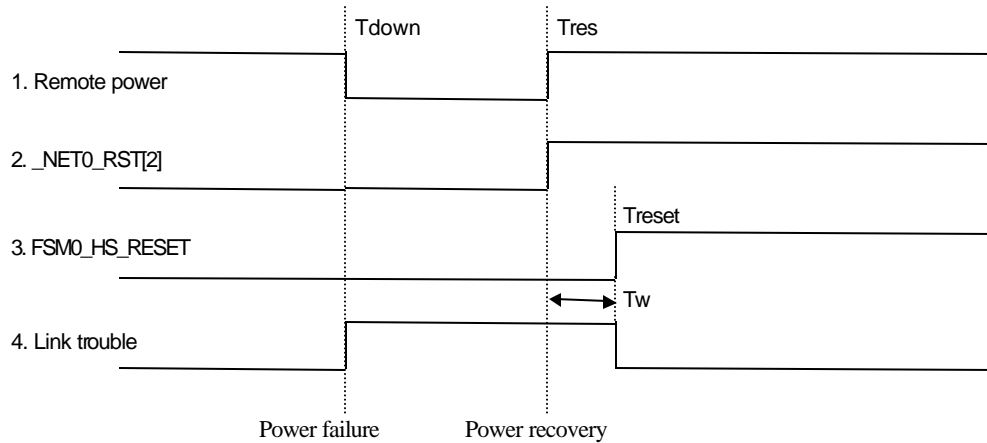

Fig. 6.6.5(B) Power recovery timing drawing of remote I/O

If power of remote station becomes down at the point of 'Tdown' in Fig. 6.6.5(B), link-trouble information is set to 'On' to indicate power error. This maintains '1' during the time of 'Tw' to indicate instantaneous power failure of remote station until user sets _FSM0_HS_RESET flag to '1' at 'Treset' even if power is recovered at 'Tres'.

6.6.6 Special module access by using _NETx_LIV[n] and _NETx_RST[n]

This explains how to control special module of remote I/O station using _NETx_LIV[n] and _NETx_RST[n] in remote system of Fig. 6.6.4(A).

Special module control of remote I/O has following differences between special module mounted in CPU.

- 1) Initialization *function block* is made through communication. Therefore, the program that retries until initialization is finished is needed, because initialization may not be made at a time by communication error and the others.
- 2) Power monitor program is needed, because initialization should be performed again when power of remote station becomes down and recovered during operation.
- 3) Rising input should be made, because read/write *function block* of special module is performed at risingedge of 'Request input'.
- 4) Program can be effectively performed if flag that monitors operation of other station is used, because communication may be impossible by power failure or communication cable dismounting of remote station.

6. Communication program

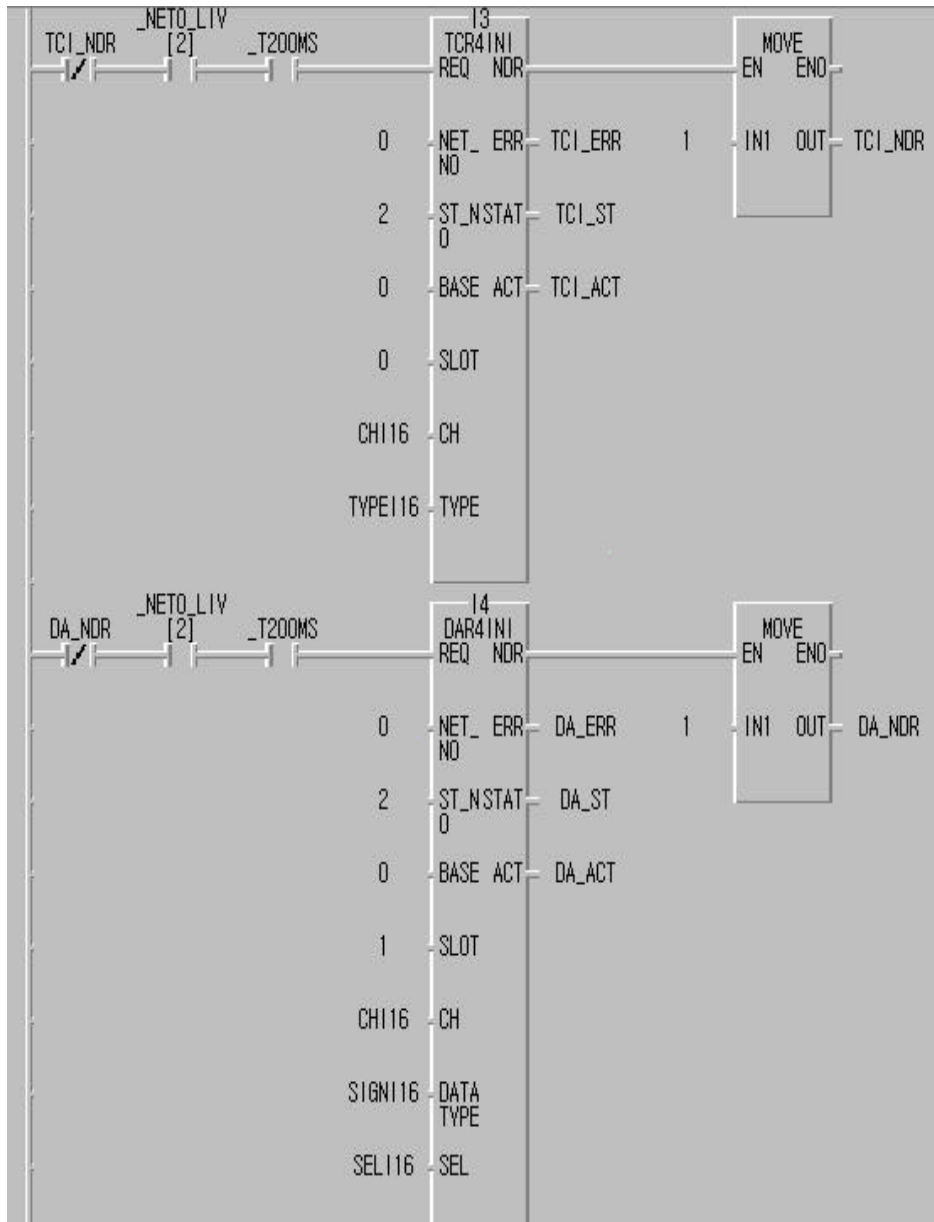

Fig. 6.6.6(A) Special module initialization program of remote I/O

Fig. 6.6.6(A) explains a program that initializes T/C and D/A module of slot 0 and 1 in remote system of Fig. 6.6.4(A). Read/write command can be performed only if special module initialization is successfully performed. To do this, NDR output of initialization F/B is set to 'B contact' for initialization request condition, and a program is made to retry with a period of 200ms until initialization is finished.

To make initialization *function block* not performed again after initialization is finished, NDR output with B contact is used as initialization request condition to perform it only once. To perform initialization in normal operation status, `_NET0_LIV[2]` flag is used to monitor operation of FMM in slot 0 and remote station 2. Program can be efficiently performed if `_NET0_LIV[2]` flag is used as request input in read/write *function block* of special module after initialization is finished.

Fig. 6.6.6(B) is an example of program, which initializes special module of remote station again when power of remote I/O station becomes down and recovered, and this should be used together with the program of Fig. 6.6.6(A).

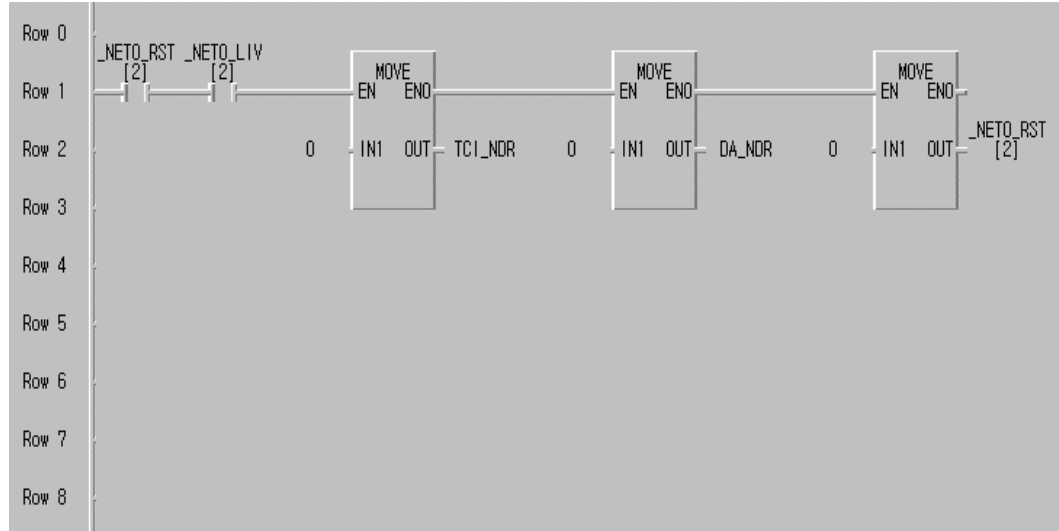

Fig. 6.6.6(B) Restart program when power failure is recovered

In Fig. 6.6.6(B), serial connection is made between `_NET0_RST[2]` and `_NET0_LIV[2]` flag to monitor other station when other station is recovered after power failure. At this time, each NDR output of initialization *function block* is cleared to perform initialization program of Fig. 6.6.6(A) again. After using `_NET0_RST[2]` flag, user should clear this flag as Fig. 6.6.6(B) to perform re-initialization only once and to reuse it for next power failure recovery, because this flag maintains final value until user clears it.

6.6.7 Setting emergency output data setting of remote module

If remote module cannot perform normal operation more than definite time(3~7sec.) because of communication line error connected in remote module, power error of master station, power failure and the others, then remote module outputs emergency data.

Emergency data can be specified using mode switch located in front of remote module(See 3.2.6 Fnet setting).

By mode switch setting :

1) Latch

Data of previous time point than the time when remote communication module cannot receive normal data is outputted and maintained(factory default).

2) User defined

User sets any data, and outputs specific data to remote I/O module.

(1) Specification by GMWIN emergency output data

After connecting remote I/O by remote 1 / 2 connection, choose 'Emergency Data' in On-line menu(See 6.4.2 GMWIN remote connection).

If user click 'Emergency output data', dialog box that user can specify emergency output data value of appropriate remote station is displayed as Fig. 6.6.7(B).



Fig. 6.6.7(A) On-line menu of emergency output data

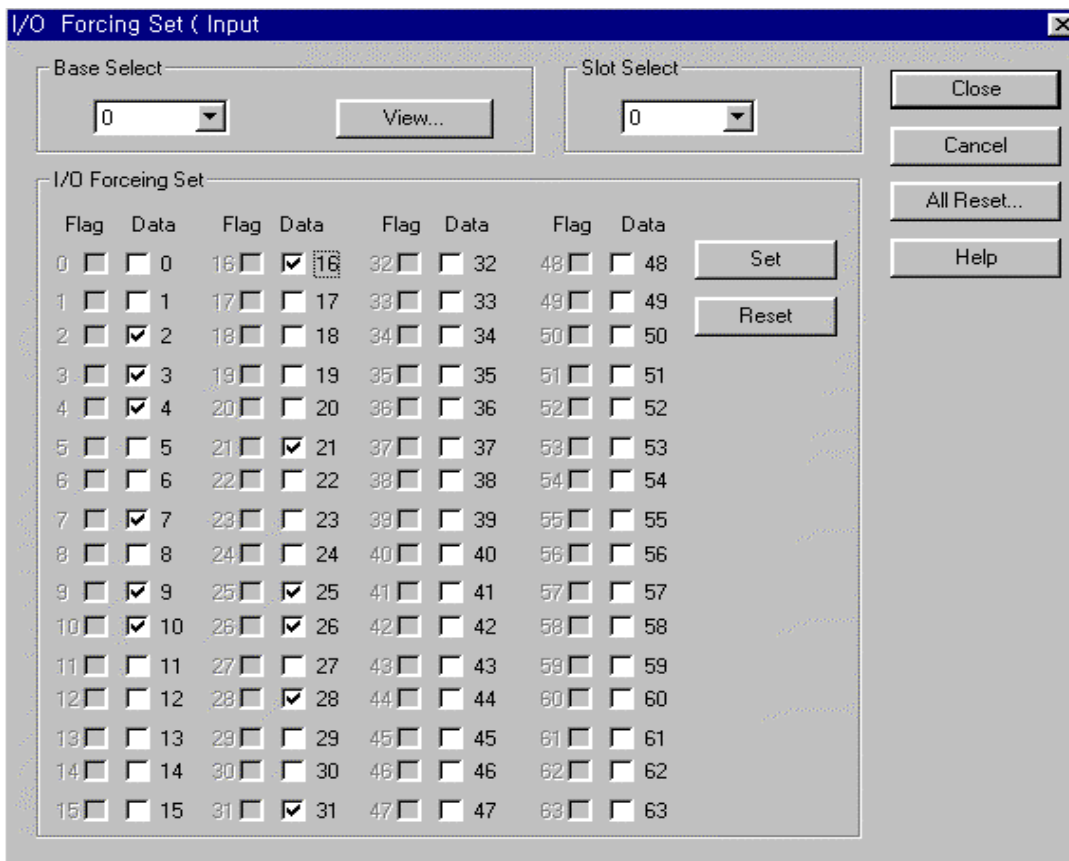

Fig. 6.6.7(B) Setting screen of emergency output data

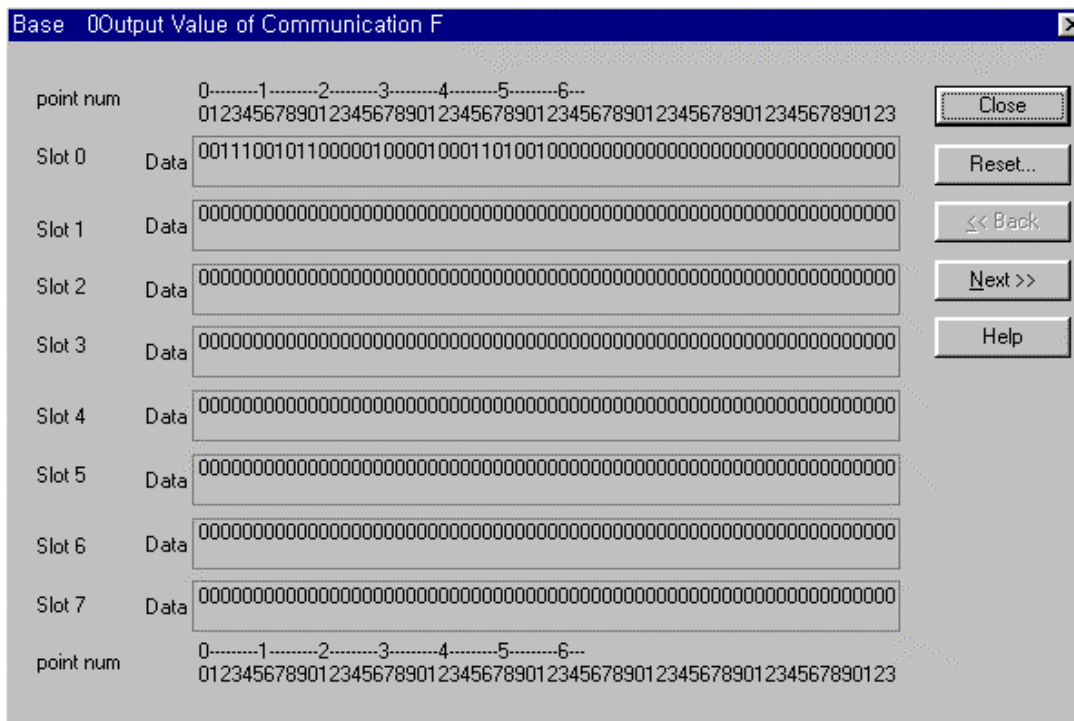

Fig. 6.6.7(C) Ex. of emergency output data setting according to base

6. Communication program

4 base(0~3) can be specified for base selection, and a base consists of 8 slot(0~7) and this can be set according to each slot. The contact that data box is marked in Fig. 6.6.7(B) is set to 'On' when emergency occurred, and user just click setting button whenever the setting according to each slot is finished.

If user click 'View setting' button in base selection box, user can monitor emergency output data value according to slot of appropriate base as Fig. 6.6.7(C). If all data values are specified, click 'Exit' to finish setting.

Remark

Emergency data set by above method is eliminated when power-off of remote communication module occurred. To make the emergency output performed regardless of power On/Off of remote module, use '_BASEx_DATA' flag that explained in the following.

(2) Emergency data specification using _BASEx_DATA flag

User can set certain data for each remote I/O module using '_BASEx_DATA' flag of FSM communication flag in *function block*, and this data is not eliminated even if power off of remote station occurred and emergency data can be simply maintained and outputted by downloading *function block* program. 'x' of _BASEx_DATA indicates base number of remote station, and this can be set to 0~3.

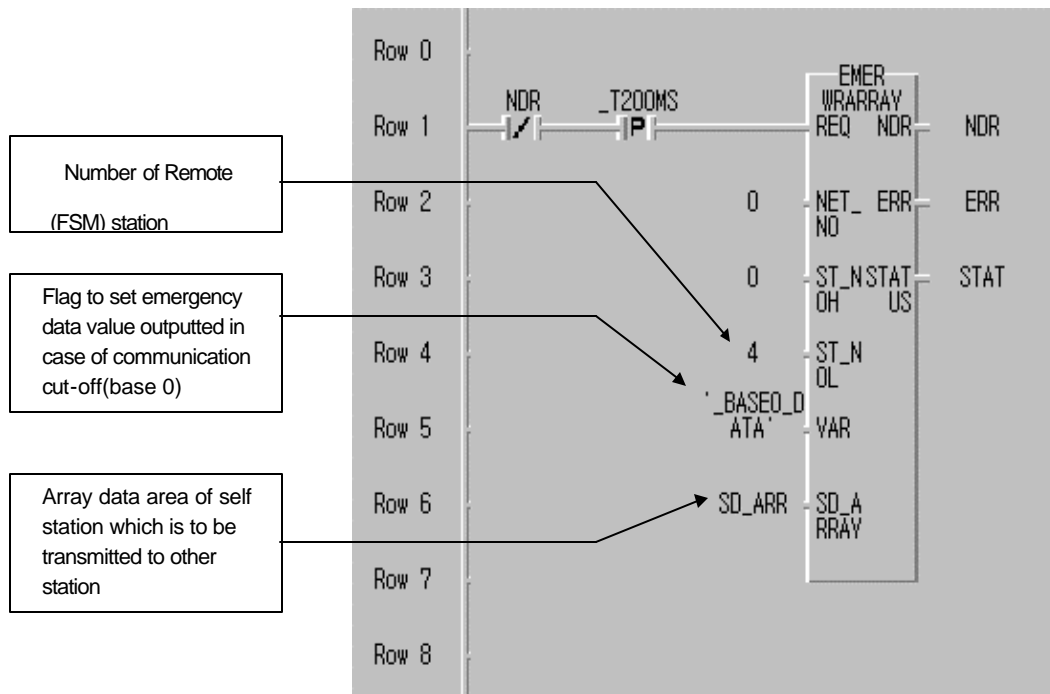

Fig. 6.6.7(D) Ex. of emergency data output program using _BASEx_DATA flag

Fig. 6.6.7(D) shows an example that transmits user-defined emergency data to remote station using `_BASEx_DATA` of FSM communication flag by GMWIN program. `WRARRAY` is used for *function block* as shown in Fig. 6.6.7(D). `NET_NO` indicates slot location that communication module(FMM) that this communication block is executed is mounted. Set `ST_NOH` to '0' and enter station number of remote module into `ST_NOL`. Use '`_BASE0_DATA`' flag(if remote 0 base) for variable identifier(VAR) to be transmitted to other station, and set `SD_ARR` that array data of self station to be transmitted to other station(station 04) to `SD_ARRAY`.
Specify data type as 'Array (0.. 31) OF WORD' in 'Variable add/edit' list as Fig. 6.6.7(E). (Set array number to 32 and set type to word type, because a slot is fixed with 4 word and a base can mount up 8 slot)

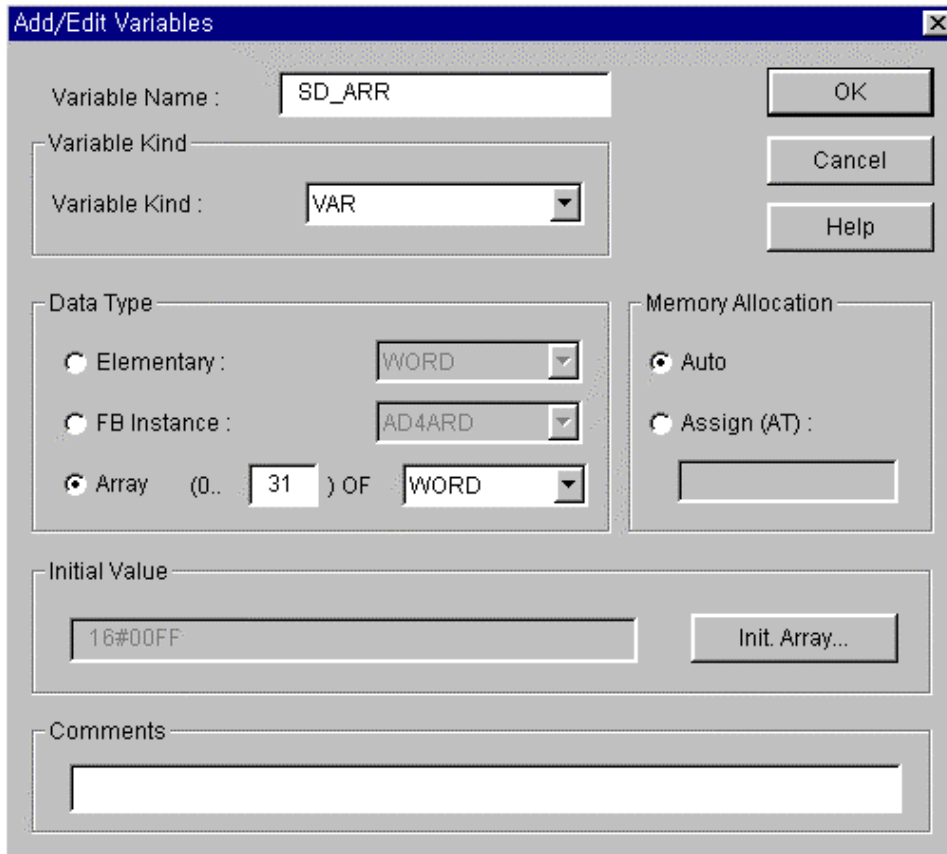

Fig. 6.6.7(E) Ex. of array data SD_ARRAY setting

To enter emergency data according to each slot, click 'Array initialization list' of Fig. 6.6.7(E), then 'Variable initialization' screen is displayed. Select 'Initialization' in dialog box and press 'Edit', then user can enter user-defined emergency data as Fig. 6.6.7(G).

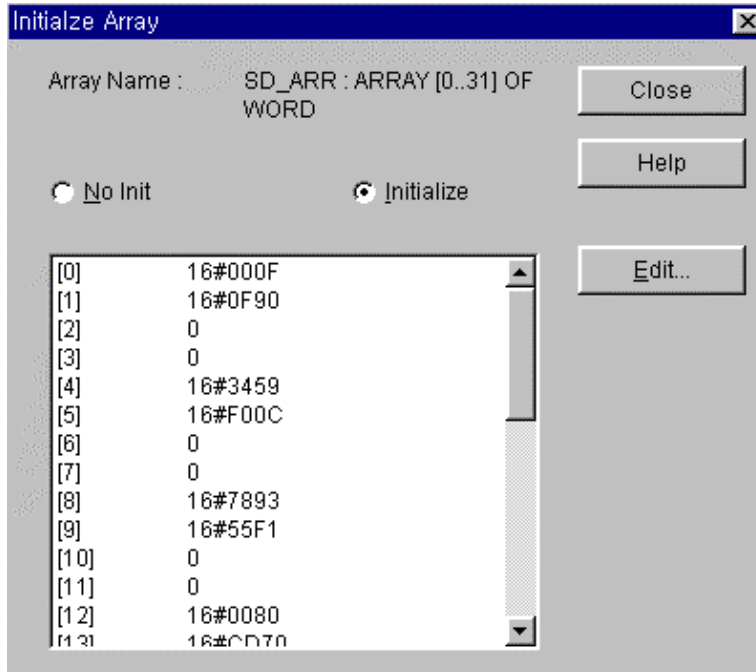

Fig. 6.6.7(F) Array initialization setting screen

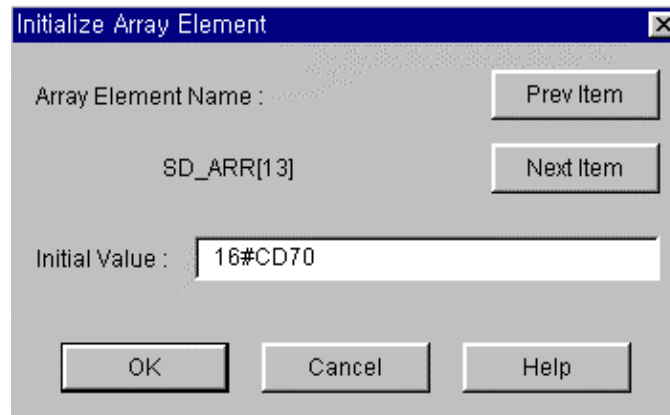

Fig. 6.6.7(G) Array element initial value input

Chapter 7 Diagnosis function

7.1 Self diagnosis function of Fnet communication module

7.1.1 Self diagnosis function during running

Error type occurred during normal operation can be known through LED which located on the front of the product. When LED operation is abnormal, see appendix A1.1/A1.2 LED indication if user can fix the error through relevant action, and contact Service station of our company for serious error of hardware.

Items	Contents	Remark
Diagnosis function (Initial self diagnosis)	<p align="center">** On-line mode **</p> 1) Memory access error of communication module 2) Common RAM access and Reading/Writing error 3) Interface error of PLC and IBM_PC 4) Frame error during communication 5) Error status in physical layer of other station during communication 6) Error in physical layer of self station during communication 7) Program execution error during communication	Error code is displayed through LED when error occurred (See Appendix A1.1/A1.2)
Diagnosis function (Communication diagnosis)	<p align="center">** Test mode **</p> 1) Diagnosis of network configuration status in physical layer by test. – Transmission error of physical layer – Receive error of physical layer 2) Interface error of CPU in communication module and communication chip.	Error code is displayed through LED when error occurred

7.1.2 Communication diagnosis by test mode

If LED indicates modem or cable problem of Fnet module, connect two module of Fnet with communication cable as Fig. 7.1.2, set the two station numbers identically, set operation mode switch on front part to test mode, and turn the power on, then diagnose the problem according to LED indication.

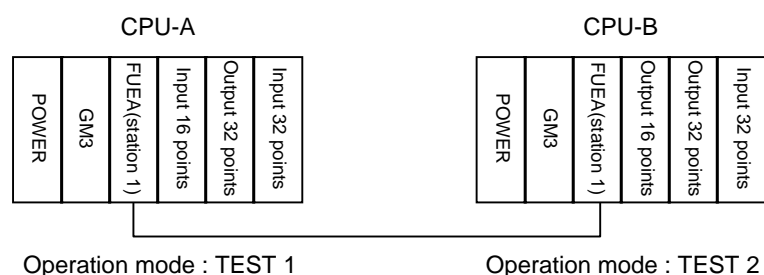

Fig. 7.1.2 Configuration of test system

7. Diagnosis function

● How to test

In a system configuration shown above, checks H/W between CPU-A and CPU-B and connection status.

- 1) In a test system configuration shown above, turn the power of CPU-A and CPU-B off and set the mode switch of appropriate module as follows :
 - ◆ Mode of communication module, CPU-A = TEST 1 (Transmission mode of communication test)
 - ◆ Sets station number switch of CPU-A to station 1 (Communication test for station 1)
 - ◆ Mode of communication module, CPU-B = TEST 2 (Receive mode of communication test)
 - Don't change values of other switches.
 - ◆ Sets station number switch of CPU-B to station 1 (Communication test for station 1)
- 2) Power on CPU-A and CPU-B.
- 3) LEDs in communication module of CPU-A are operated as follows :

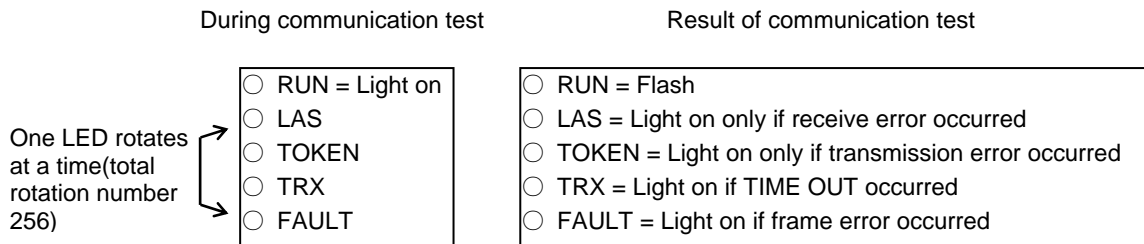

During communication test, rotates up while lighting on FAULT ► TRX ► TOKEN ► LAS ► FAULT LED 256 times, with RUN LED on. Test result is displayed through LED and the meanings are as shown above. These are displayed during two seconds, and reads station number switch and keep executing with the station.

- 4) LEDs in communication module of CPU-B are operated as follows :

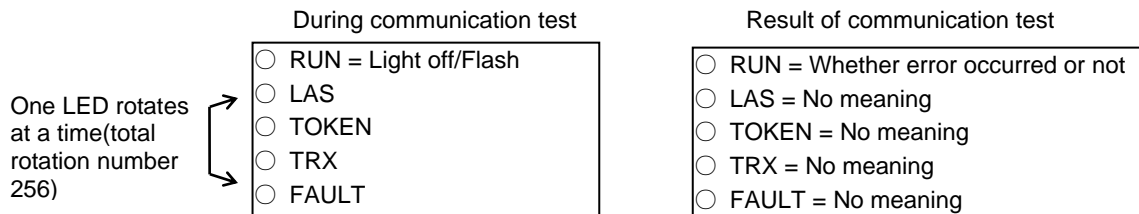

During communication test, rotates up while lighting off FAULT ► TRX ► TOKEN ► LAS ► FAULT LED 256 times, with RUN LED on. Test result is displayed through RUN LED and communication error occurred during test if RUN LED is turned on.

If error occurs after testing, check the test condition is correct or not. If the same error occurs continuously, contact Service station of our company.

7.2 Mnet diagnosis function

7.2.1 Diagnosis function types of Mnet communication module

Items	Contents	Remark
Diagnosis function (Self diagnosis + communication diagnosis)	<p style="text-align: center;">** On-line mode **</p> 1) Memory access error of communication module 2) Common RAM access and Reading/Writing error 3) Interface error of PLC and PC 4) Modem error during communication 5) Error status in physical layer of other station during communication 6) Error in physical layer of self station during communication 7) Program execution error during communication	Error code is displayed through LED when error occurred (See appendix A1.7)
	<p style="text-align: center;">** Test mode **</p> 1) Diagnosis of network configuration status in physical layer by test. <ul style="list-style-type: none"> – Interface error of common RAM – Transmission error of physical layer – Receive error of physical layer – Loop back test of physical layer 2) Interface error of CPU in communication module and TBC	

7.2.2 How to diagnose Mnet communication module

Diagnosis of Mnet communication module is made by setting mode switch which is attached on front part of communication module to 2(test 2), and executed with the status that communication cable is not connected. Test1 and test2 are executed internally. Test contents according to each item are as follows :

Test 1

- Interface of common RAM
- Transmission test of physical layer
- Receive test of physical layer

Test 2

- Interface of common RAM
- Loop back test
- Interface of CPU in communication module and TBC

7. Diagnosis function

- ◎ Test sequence
 - ① Sets mode switch to 2 with power off
 - ② Power on

- ◎ Contents of execution
 - ① Power on and execution of test 1
LED status ●○○○○ (RUN LED on)

 - ② The result of test 1 is normal and execution of test 2
LED status ●○○●○ (RUN, IN-RING LED on)

 - ③ If the result of test 1 is abnormal
LED status ●○○○● (RUN, FAULT LED on)

 - ④ If the result of test 2 is normal
LED status ○○○●● (FAULT, IN-RING LED on)

 - ⑤ If the result of test 2 is normal
LED status ○○○○● (FAULT LED on)

If test is finished at abnormal LED status as ③ and ⑤, contact Service station of our company.

Chapter 8 Installation and testing operation

8.1 Installation and testing operation of Fnet communication module

GLOFA communication module should be appropriately mounted according to PLC CPU type, and products of communication module which can be mounted according to CPU type are as follows :

Table 8.1 Mounting of communication module according to CPU type

CPU type	Mountable device type	Max. mounting number	Mounting location (slot)	Remark
GM1	G3L-MUEA, G3L-FUEA, G3L-FUOA	4	Main base I/O	
GM2	G3L-MUEA, G3L-FUEA, G3L-FUOA	4	Main base I/O	
GM3	G3L-MUEA, G3L-FUEA, G3L-FUOA	4	Main base I/O	
	G3L-RBEA, G3L-RBOA	1	CPU	Remote I/O
GM4	G4L-FUEA	2	Main base I/O	
	G4L-RBEA	1	CPU	Remote I/O
GM5	G5L-FUEA	1	I/O	
GM6	G6L-FUEA	2	I/O	
FAM4.0	G0L-FUEA	1	16 bit extended slot	Mounted in PC
FAM4.0	G0L-MUEA	1	16 bit extended slot	Mounted in PC
-	G0L-SMQA	1	Stand-alone type	Remote output
-	G0L-SMIA	1	Stand-alone type	Remote input
-	G0L-SMHA	1	Stand-alone type	Remote combined

8.1.1 Installation of Fnet master module

- 1) In the types of master module, there are electric communication module of G3L-FUEA, G4L-FUEA, G5L-FUEA and G6L-FUEA, optical communication module of G3L-FUOA, and G0L-FUEA which is used in IBM-PC. Communication module can be mounted up to 4 in GM1, GM2, and GM3 PLC, and these can be mounted only in main base.
- 2) Communication module can be mounted up to 2 in main base in GM4 and GM6 PLC(Extended base is not available for this module).
- 3) Only one G5L-FUEA module can be mounted in GM5 PLC, and mount it the first location of extended base.
- 4) G0L-FUEA is mounted in one of 16 bit extended slot of compatible IBM PC, and setting of port and memory address shouldn't be duplicated with other device's(See 3.2.3 G0L-FUEA structure).

8. Installation and testing operation

8.1.2 Installation of Fnet slave module

In types of slave module, there are electric communication module of G3L-RBEA and G4L-RBEA, optical communication module of G3L-RBOA, and standalone remote(G0L-SMQA, G0L-SMIA, G0L-SMHA) I/O station of 16 point output, input, and combined.

Fig. 8.1.2 shows example of mounting and extending of slave in GM base.

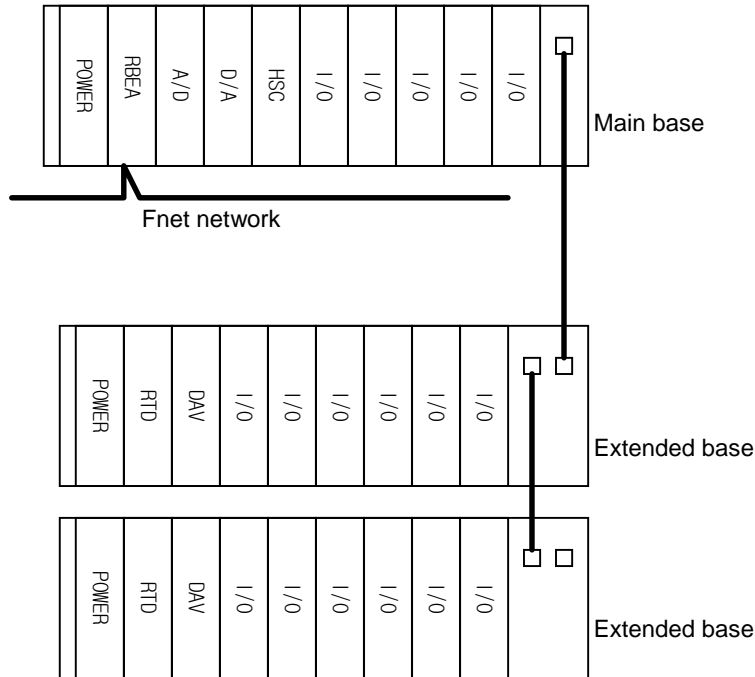

Fig. 8.1.2 How to mount and install

Table 8.1.2 shows list of module, which can be used with FSM.

Table 8.1.2 Mountable device in FSM

Available module name	Not available module name	
Product name	Product name	Type name
All types of I/O module	Coordinator module	GM1-CORA
	Interface module	All types
D/A conversion module	Interrupt input module	G□F-INTA
Temperature conversion module	Fnet module	G□I-FUEA/FUOA
	Mnet module	G3L-MUEA
High speed counter module	PID control module	G□F-PIDA
	Analog timer	G□F-AT□A
A/D conversion module	PC communication module	G□L-CUEA

See mounting method of the manual according to CPU type for mounting method of base module.

8.1.3 Installation procedure of Fnet module

- 1) Install standard configuration that is needed in system configuration, and select communication module relevant to the type of device.
- 2) This communication module should be mounted when power is off.
- 3) When mounting this communication module, check whether connector of base that module will be mounted has foreign matters or not, and check whether connector pin of this module is normal.
- 4) All communication modules can't be mounted in extended base, they can be mounted only in CPU position of main base.
- 5) Combined mounting of Mnet module and Fnet master module is possible in device of GM1, GM2, and GM3. But mounting number of combined configuration should be 4 or less.
- 6) When mounting this module, insert projecting part of lower part into groove of base board exactly and press it until upper part is locked with locking device of base board, before connecting communication cable. If locking device is not locked completely, error of interface with CPU may be occurred.
- 7) Sets station number and operation mode using switch on the front part of communication module. There should be no duplicated station number in the same network.
- 8) Connect communication cable after mounting electric module, and install terminal resistance at CON1 or CON2 if this module is terminal (Fnet:110Ω, Mnet:75Ω).
- 9) Electric module cable should be connected tightly using screw of cable connector. If mounted station is not terminal, both side of cable can be connected any of CON1 and CON2.
- 10) Turn the power on after connecting communication cable, check whether this module operates normally through LED operation status. If it is normal, download corresponding program to GMWIN and execute the program.
- 11) After mounting optical communication module, insert projecting part of cable connector into groove of communication module connector while pushing connector of optical connector into communication module connector and turning it clockwise direction.
- 12) Communication module for PC can be mounted in ISA bus, and switch of port address and memory address in this module should be configured according to memory environment of PC before mounting it. If port and memory are set to currently using area in PC memory environment, abnormal operation may be occurred or booting may not be possible(See 3.2.3 GOL-FUEA structure). Switch values of port and memory settings of this module are in appendix.
- 13) To mount communication module for PC, insert a module into slot accurately and tighten the module up with screw of upper part not to be shaken, before connecting communication cable.

8. Installation and testing operation

8.1.4 Cautions on installation of Fnet module

- 1) All other station including this station should have different station number. If duplicated number is used in connection, communication error occurs and normal communication is not possible.
- 2) If module is operated with normal communication, mode switch should be in Run mode. If mode switch of this module is set to test1 and turn the power on when other stations that are connected in network are already in communication, serious error may be occurred in communication of other stations.
- 3) For communication cable, cable of specified specification should be used. Using not specified cable may cause serious communication error.
- 4) Check whether communication cable has disconnection or short, before installation.
- 5) Tighten communication cable connector to fix the cable connection. If cable connection is not perfect, serious error can be occurred.
- 6) If communication cable is twisted as the following figure or not connected well, problem can be occurred in communication.

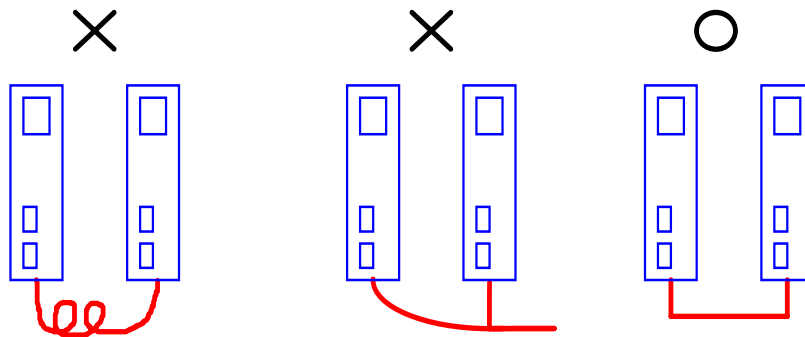

- 7) Branch of cable is not allowed.

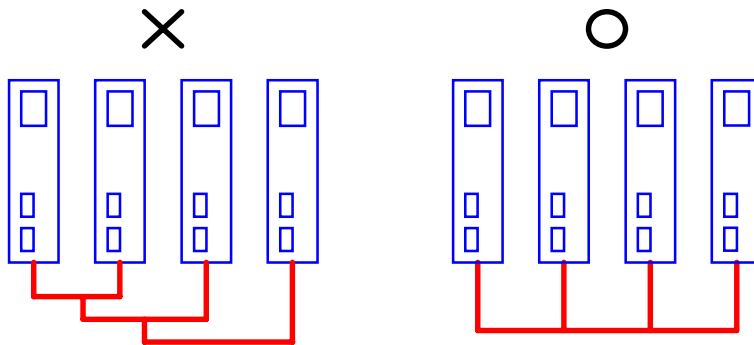

- 8) Connection of network through communication cable should not be a closed circuit.

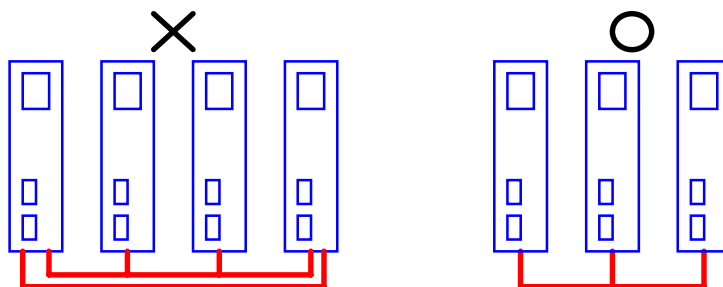

- 9) Choose one from both terminals in network system, connect its terminal connector with FG of PLC or installed device as the following.

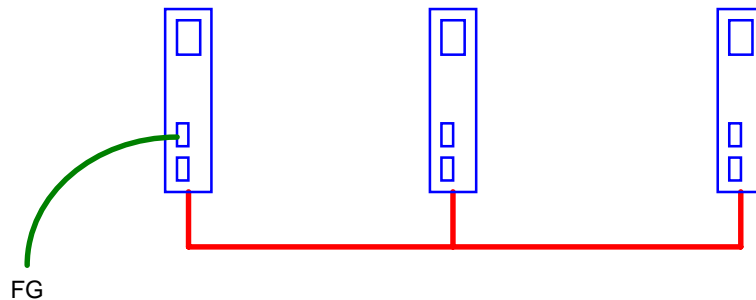

Remark

If communication status is bad when connection is made as above, this is caused by serious noise from FG. Therefore, user should eliminate its cause or not connect to FG.

- 10) If communication cable is connected with long distance, wiring should be far away from power line or inductive noise.
- 11) Shield line of communication cable (twisted pair) should be connected firmly with connector body inside of the 9 pin metal case for connection (See 4.4.1 Electric (twisted pair) cable wiring).
- 12) Optical communication cable consists of TX and RX line. Connect them to Tx/Rx connector of optical communication module as the following figure. If polarity of Tx/Rx is changed each other, communication is impossible, so polarity should not be changed (See 4.3.3 Optical cable connection).

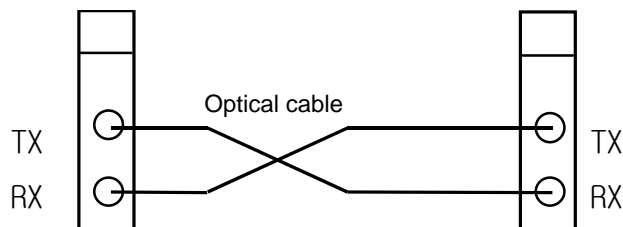

- 13) For not using connector of optical communication module, cover should be used on connector part to prevent foreign matters from coming in.
- 14) If LED operation is abnormal, see 'chap. 9 Troubleshooting' of this manual to check the cause of the error. If the error occurs continuously after management, contact Service station.

8. Installation and testing operation

8.1.5 Preparations during testing operation of Fnet module

This explains contents to be checked before testing operation of Fnet communication module.

1) Communication module to be mounted in PLC

Items to be checked	Contents
Mounting check of Base module	<ul style="list-style-type: none">- Does using voltage of power module comply with specifications of power module?- Is battery of CPU module connected?- Is mounting of all base modules perfect? ⇒ See product manual according to each PLC type.
Connection status of Communication cable	<ul style="list-style-type: none">- Is connection status of communication cable perfect?- Is connection type of each cable open loop?
Module mounting	<ul style="list-style-type: none">- Is mounting status of communication module which is mounted in basic base perfect?
Switch checking	<ul style="list-style-type: none">- Is the status of mode switch On-line (switch value is 0)?- Is station No. switch correctly set?- Is master station No. switch correctly set? (for slave module)- Is output option switch correctly set when communication is cut off? (for slave module)

2) Communication module to be mounted in PC

Items to be checked	Contents
Standard check	<ul style="list-style-type: none">- Is PC appropriate IBM-PC compatible?- Has PC sufficient environment to install FAM4.0/GMWIN?- Has PC space and empty slot to mount this module?- Can memory map of PC reserve empty space to use this module? ⇒ See user's manual of FAM4.0/ GMWIN and Appendix of this manual.
Module mounting and FAM4.0/GMWIN installation	<ul style="list-style-type: none">- Reserve empty space of 32K byte in memory map of PC, select this area for the memory switch of this module, set port address.- Mount and fix this module into the slot to be inserted.
Switch recheck	<ul style="list-style-type: none">- Are memory switch and port switch correctly set?- Is mode switch set to On-line (switch value is 0) status?- Is station number switch correctly set?

8.1.6 Testing operation procedure of Fnet module

This shows the sequence from completion of PLC installation to the testing operation.

1) Communication module to be mounted in PLC

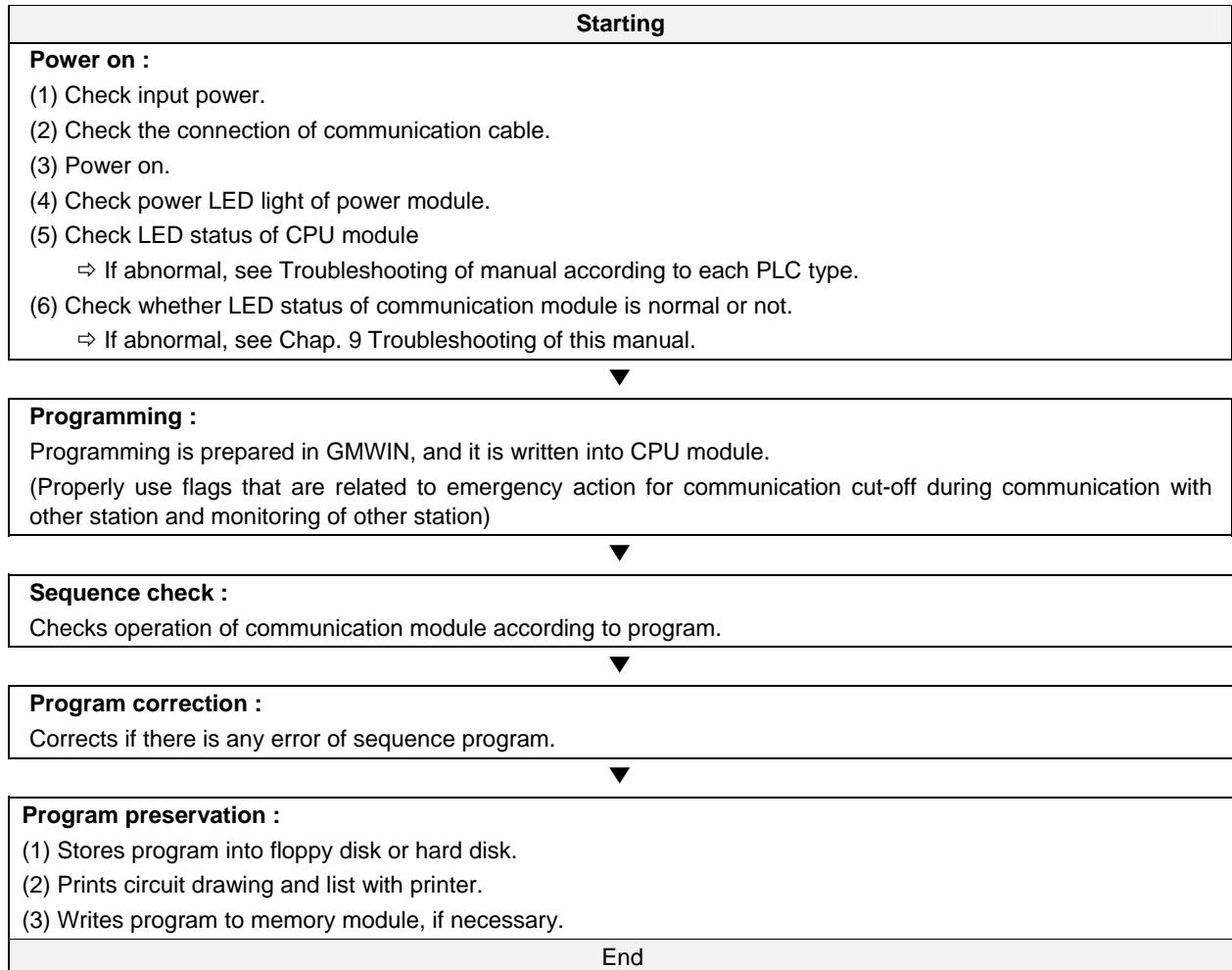

8. Installation and testing operation

2) Communication module to be mounted in PC

Starting

Power :

- (1) Check input power.
- (2) Check the connection of communication cable(when cable is connected).
- (3) Power on.
- (4) Check booting status of PC.
⇒ If abnormal, see Chap. 9 Troubleshooting of user's manual in FAM4.0/GMWIN.
- (5) Check whether LED status of communication module is normal or not.
⇒ If abnormal, see Chap. 9 Troubleshooting of this manual.
- (6) Check whether this module is initialized or not by executing FAM4.0/GMWIN.
⇒ See user's manual of FAM 4.0/GMWIN.
- (7) Check LED status of this module.
⇒ See 'Appendix LED status' of this manual.
If the operation is abnormal, see chap. 9 Troubleshooting.
- (8) Preparation and execution of program to be executed.
⇒ See user's manual of FAM4.0/GMWIN.
If the operation is abnormal, see chap. 9 Troubleshooting of this manual.



End

- (1) Stop all execution of FAM4.0/GMWIN, and finish.
- (2) Check LED of this module.

8.2 Installation and testing operation of Fnet option unit

8.2.1 Active coupler of Fnet

1) Mounting and installation

Active coupler means the assembly of G0L-FAPA(Power)/ G0L-FABA(Base)/ G0L-FACA(Module), and this is used to dispart and connect optical signal to many places.

Fig. 8.2.1 shows example of active coupler communication module

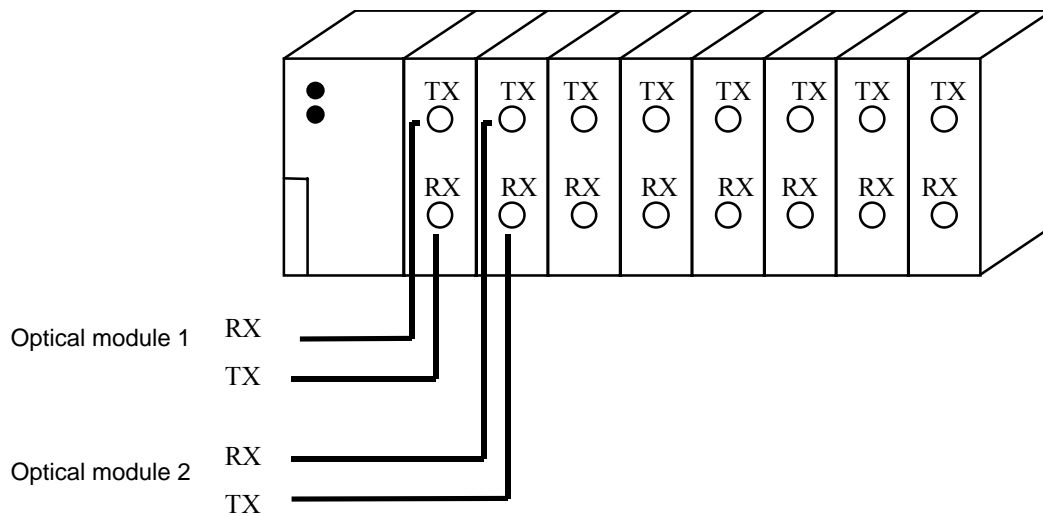

Fig. 8.2.1 Example of active coupler mounting

- (1) Prepare standard configuration that is needed in system configuration, and select communication module that is relevant to the device type.
- (2) This communication module should be mounted when power is off.
- (3) When mounting this communication module, check whether connector of base that module will be mounted has foreign matters or not, and check whether connector pin of this module is broken or not.
- (4) When mounting this module, push active coupler module into groove of upper and lower body in active coupler before connecting communication cable. Push it hard to be completely inserted in base board.
- (5) Connect communication cable after mounting this module.
- (6) Mount dummy module(G0L-FADA) to protect unused slot from foreign matters like dust or others.

8. Installation and testing operation

8.2.2 E/O converter(Electric/optical signal converter)

This module(GOL-FOEA) converts electric and optical signal of Fnet each other, and this can be configured as follows :

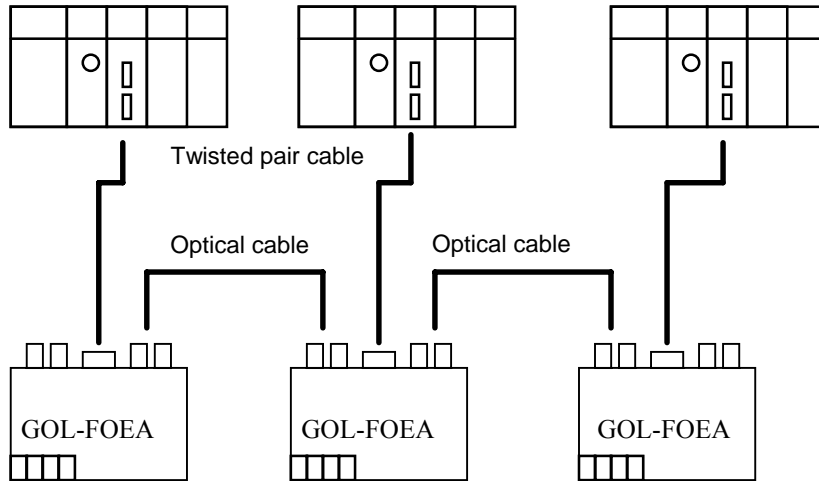

[When optical cable is used to connect between Fnet modules of many stations]

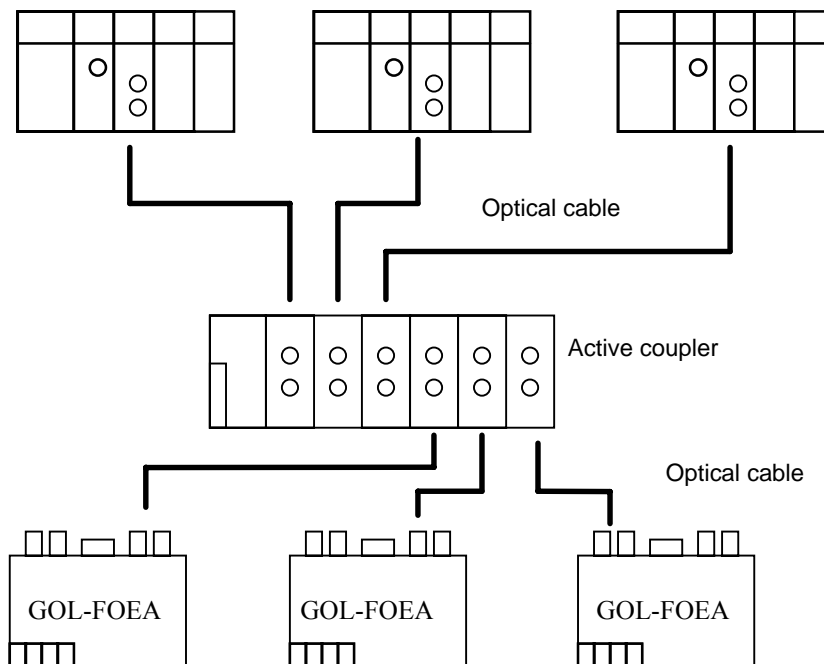

[When optical cable is used to connect between Fnet modules of many stations using active coupler]

- 1) Prepare standard configuration that is needed in system configuration, and select communication module that is relevant to the device type.
- 2) This communication module should be mounted when power is off.
- 3) Connect communication cable after mounting this module.
- 4) Completely connect the connector of optical cable by accurately inserting in Tx/Rx.

8.2.3 Repeater(Electric signal restructure)

Repeater(GOL-FREA) is used to restructure the electric signal of Fnet. Installation method is as follows :

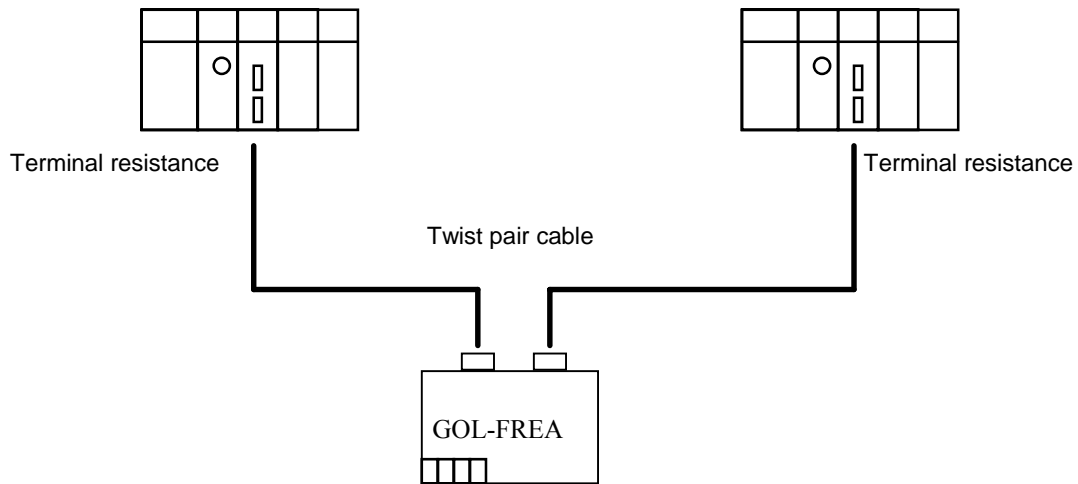

[When the signal between Fnet modules is restruct(to make the signal level 'High')]

- 1) Prepare standard configuration that is needed in system configuration, and select communication module that is relevant to the device type.
- 2) This communication module should be mounted when power is off.
- 3) To connect the cable of electric module, tighten the screw of cable connector to confirm the connection. Terminal resistance is built in the repeater.

8.3 Installation and testing operation of Mnet communication module

8.3.1 Mounting and installation

In the type of Mnet communication module, there are G3L-MUEA and G0L-MUEA that is used in PC. Communication module can be mounted up to Max.4(including Fnet) in main base of GM1, GM2, and GM3 PLC. Example of mounting is as following figure.

Fig. 8.3.1(A) Example of G3L-MUEA module mounting

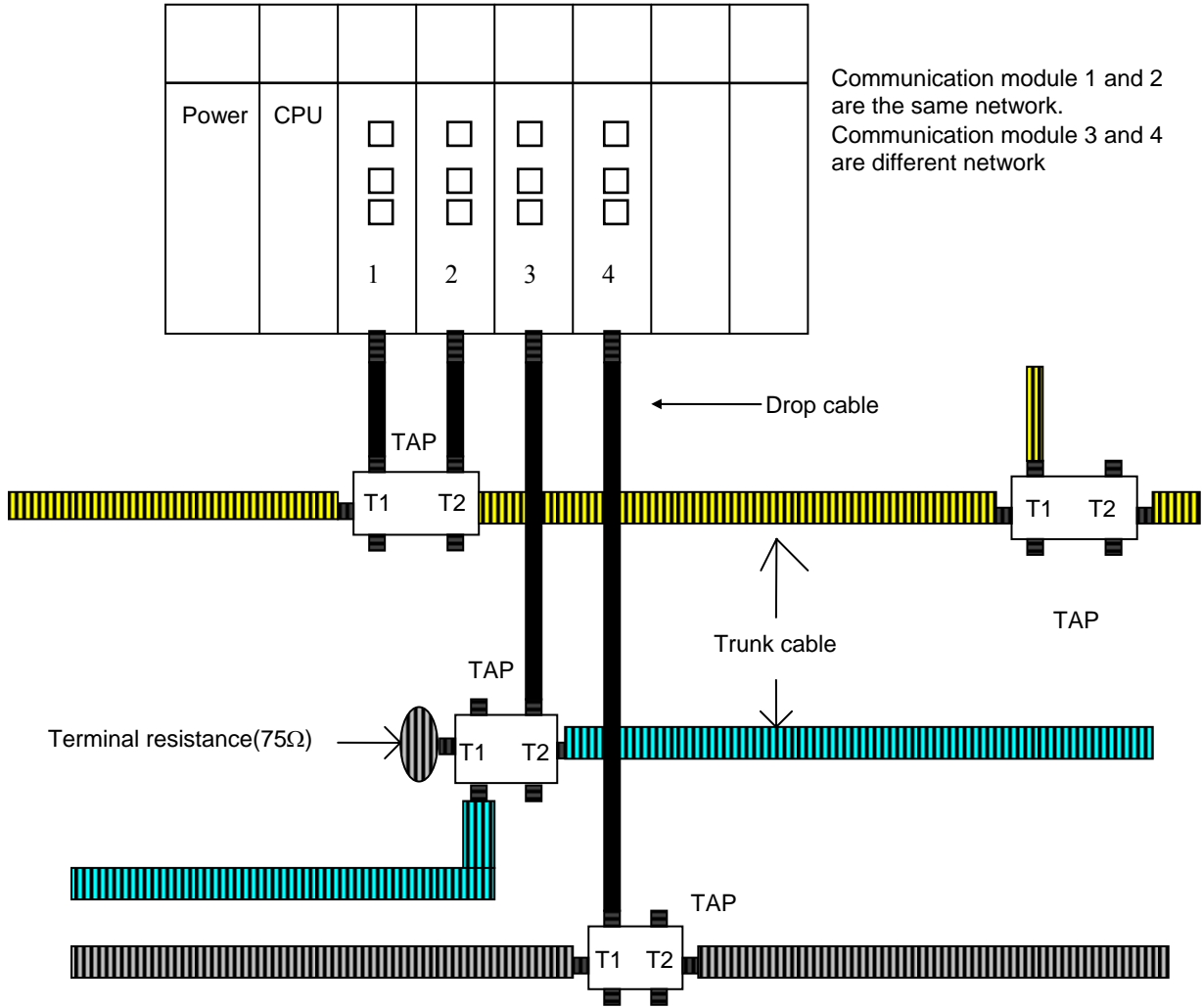

Remark

1. Max. distance of trunk cable between TAPs is 700m.
2. Drop cable between TAP and Mnet communication module is max. 50m.
3. Operate while paying attention to TAP direction.

4. Connect the screw for shield connection at the back of TAP with pannel FG.

Fig. 8.3.1(B) Example of mounting of GOL-MUEA module in PC(mounted in 16 bit AT bus)

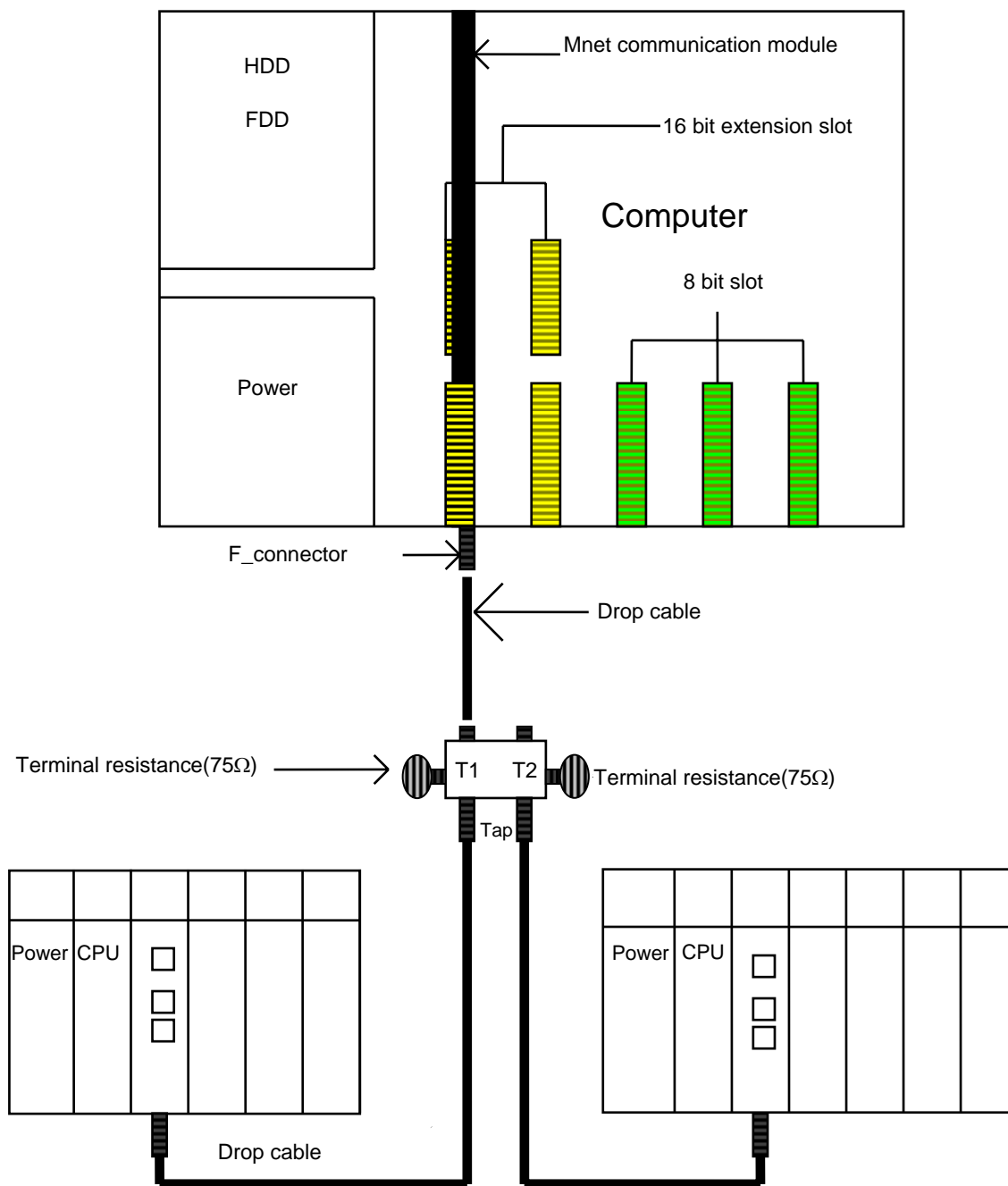

Remark

1. Max. distance of trunk cable between TAPs is 700m.
2. Drop cable between TAP and Mnet communication module is max. 50m.
3. Operate while paying attention to TAP direction.

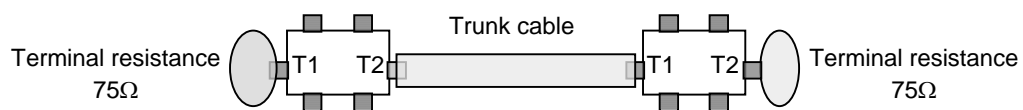

4. Connect the screw for shield connection at the back of TAP with panel FG.

8. Installation and testing operation

- 1) Install standard configuration that is needed in system configuration, and select communication module relevant to the type of device.
- 2) This communication module should be mounted when power is off on PLC.
- 3) When mounting this communication module, check whether connector of base that module will be mounted has foreign matters or not, and check whether connector pin of this module is broken or not.
- 4) All communication modules can't be mounted in extended base, they can be mounted only on main base. Communication module should be mounted in a slot that is near with CPU.
- 5) In device of GM1/2/3, combined mounting of Mnet module and Fnet master module is possible. But mounting number of combined configuration should be Max.4 or less.
- 6) When mounting this module, insert projecting part of lower part into groove of base board exactly and press it until upper part is locked with locking device of base board, before connecting communication cable. If locking device is not locked completely, error of interface with CPU may be occurred.
- 7) If network is configured using this communication module, that network should be branched and connected using the TAP for coaxial cable
- 8) In a TAP that is used to branch communication station, terminal of port should be connected with terminal resistance. If terminal resistance is not used, communication error may be occurred.
- 9) Trunk cable should be used between TAPs, and drop cable should be used between connector and TAP of communication module(If drop cable is used instead of trunk cable, communication error may be occurred).
- 10) After connecting communication cable, power on and check whether the operation is normal or not by watching the operation status of LED. If the operation is normal, download appropriate program to PLC of GMWIN, and execute the program.
- 11) Communication module for PC can be mounted in 16 bit slot, and switch of port address and memory address in this module should be configured according to memory environment of PC before mounting it. If port and memory address are set to currently using area in PC memory environment, abnormal operation may be occurred or booting may not be possible. Switch values of port and memory address settings of this module are in appendix.
- 12) To mount communication module for PC, insert a module accurately into slot and tighten the module up with screw of upper part not to be shaken, before connecting communication cable.
- 13) The distance between TAPs is max. 700m, and max. distance of drop cable from TAP to communication module is 50m.
- 14) Using TAP, connect the screw for FG connection in TAP with panel FG line.
- 15) Station number switch that is located on the front of this communication module can be used for high speed communication service only, and MAC address that is written on the case of communication module can be used for station number of other services.

8.3.2 Cautions on system configuration

- 1) All other station including this station should have different *high speed link* station number. If duplicated number is used in connection, communication error occurs and normal communication is not possible. Switch value on the front of module should not be duplicated.
- 2) If module is operated with normal communication, mode switch should be in On-line mode. If mode switch of this module is set to test and turn the power on when other stations that are connected in network are already in communicating, serious error may be occurred in communication of other stations.
- 3) For communication cable, cable of specified specification should be used. Using not specified cable may cause serious communication error.
- 4) Check whether communication cable has disconnection or short, before installation.
- 5) Tighten communication cable connector to fix the cable connection. If cable connection is not perfect, serious errors can be occurred.
- 6) If communication cable is connected with long distance, wiring should be far away from power line or inductive noise.
- 7) Coaxial cable is not flexible, so this should be branched away from connector in communication module at least 30cm. If cable is bent at right angle or deformed too much, this may cause disconnection of cable or break of connector in communication module.
- 8) Trunk cable should be used between TAPs, and drop cable should be used between connector and TAP of communication module.
- 9) If LED operation is abnormal, see ‘Chap. 9 Troubleshooting’ of this manual to check the cause of the error. If the error occurs continuously after management, contact Service station.
- 10) Dual mounting of Mnet communication module(G0L-MUEA) and Fnet communication module(G0L-FUEA) in PC is hard to be used at FAM4.0, dual mounting should be avoided.
- 11) Mounting this module, maintain sufficient gap distance(5cm or more) with other module(base and other additional mounting object) to facilitate connection and mounting of communication connector and cable.

8.3.3 Preparations before testing operation

This explains the contents to be checked before commissioning communication module.

1) Communication module to be mounted in PLC

Items to be checked	Contents
Installation and check of standard S/W	– Are installation and operation of GMWIN perfect?
Connection status of communication cable	– Are connection of communication cable and using status of TAP perfect? – Is connection type of each cable open loop?
Module mounting	– Is communication module correctly installed in main base?
Switch check	– Is mode switch On-line(switch value : 0)? – Is station number switch(<i>high speed link</i>) correctly set?

8. Installation and testing operation

2) Communication module to be mounted in IBM-PC

Items to be checked	Contents
Standard check	<ul style="list-style-type: none"> - Is PC appropriate IBM-PC compatible? - Has PC sufficient environment to install FAM4.0/GMWIN? - Has PC space and empty slot to mount this module? - Can memory map of PC reserve empty space to use this module? ⇒ See user's manual of FAM4.0/GMWIN and Appendix of this manual.
Module mounting and FAM4.0/GMWIN installation	<ul style="list-style-type: none"> - Reserve empty space of 64K byte in memory map of PC, select this area for the memory switch of this module, set port address. - Mount and fix this module into the slot to be inserted.
Switch recheck	<ul style="list-style-type: none"> - Are memory switch and port switch correctly set? - Is mode switch set to On-line (switch value is 0) status? - Is station number switch correctly set?

8.3.4 Procedure of testing operation

This shows the sequence from completion of PLC installation to testing operation.

1) Communication module to be mounted in PLC

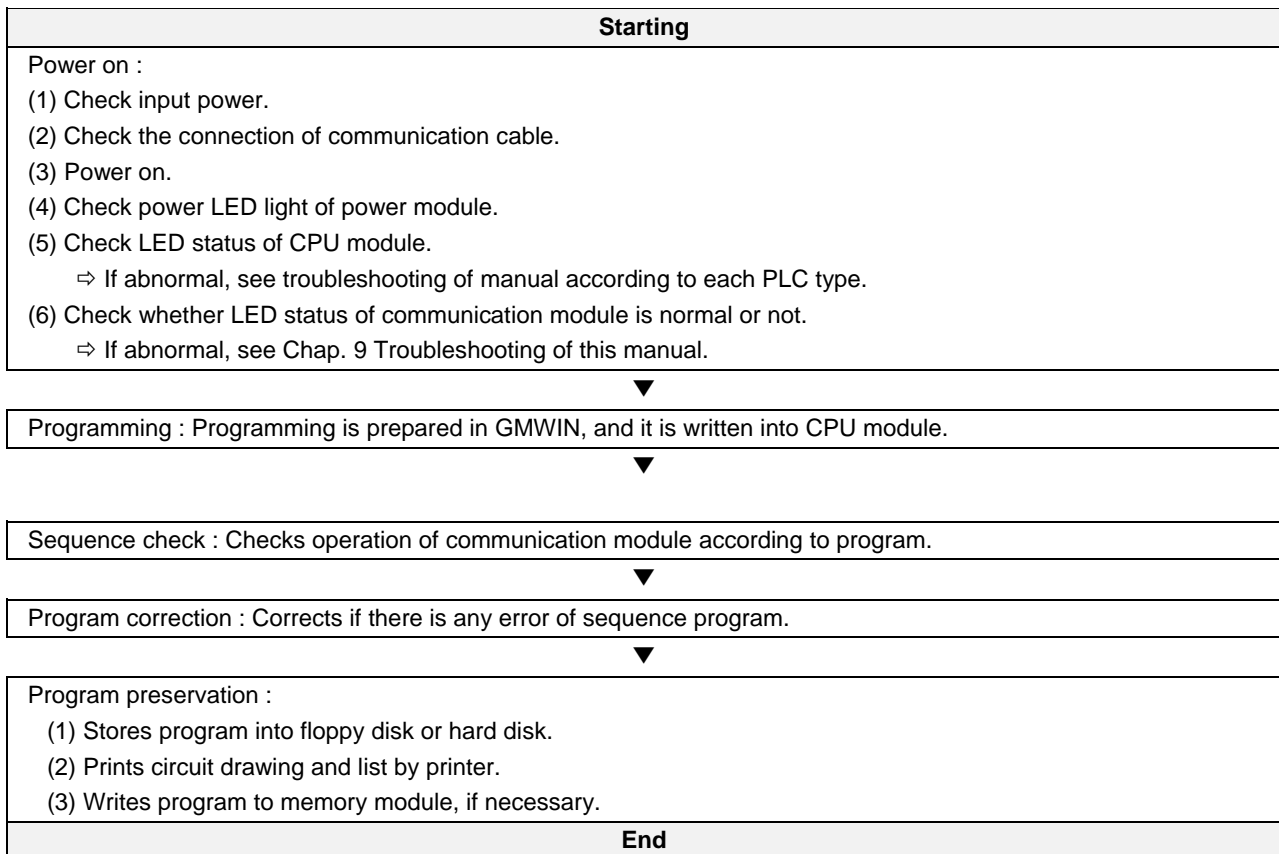

2) Communication module to be mounted in PC

Starting

Power on :

- 1) Check input power.
- 2) Check the connection of communication cable.
- 3) Power on.
- 4) Check booting status of PC.
 - ⇒ If booting is not performed, check port address and memory address which are set in communication module and set memory so as not to be duplicated with other devices used in PC.
 - ⇒ If abnormal, see Chap. 9 Troubleshooting of user's manual in FAM4.0/GMWIN.
- 5) Check whether LED status of communication module is normal or not.
 - ⇒ If abnormal, see Chap. 9 Troubleshooting of this manual.
- 6) Check whether this module is initialized or not by executing FAM4.0/GMWIN.
 - ⇒ See user's manual of FAM 4.0/GMWIN.
- 7) Check LED status of this module.
 - ⇒ See 'Appendix LED status' of this manual.
 - If the operation is abnormal, see Chap. 9 Troubleshooting.
- 8) Preparation and execution of program to be executed.
 - ⇒ See user's manual of FAM4.0/GMWIN.
 - If the operation of communication is abnormal, see user's manual of FAM4.0/GMWIN.

End

- 1) Stop all execution of FAM4.0/GMWIN, and finish.
- 2) Check LED of this module.

8. Installation and testing operation

8.4 Repair and check

Perform routine check and regular check to maintain the best status of this communication module.

8.4.1 Daily check

1) Master of Fnet

Items of routine check are as following table :

Table 8.4.1(A) Items of routine check

Items to be checked		Contents	Criteria of decision	Action to take
Cable connection status		Release of cable	Shall not be any release.	Tighten the cable.
Module connection status		Release of screw	Shall not be any release.	Tighten screw of module.
LED indication	RUN	Flicker check	Flash (Lights-out means interface cut-off with CPU).	See Appendix.
	LAS	Light on Check	LED of only one module among entire module of network should be lighted (Lights of two or more mean abnormal configuration of network).	See Appendix.
	TOKEN	Flicker check	Light off means abnormal (Duplicated station or cable error).	See Appendix.
	TX/RX	Flicker check	Light off means abnormal (Hardware error of module).	See Appendix.
	FAULT	Light off check	Regular flash means system error, and intermittence flash means communication error.	See Appendix.

2) Slave of Fnet

Items of routine check are as following table :

Table 8.4.1(B) Items of routine check

Items to be checked		Contents	Criteria of decision	Action to take
Cable connection status		Release of cable	Shall not be any release.	Tighten the cable.
Connection status of terminal block		Release of terminal screw	Shall not be any release.	Tighten screw of terminal.
		Gap between compression terminals	Shall be relevant gap.	Correct.
LED indication	RUN	Light on check	Check power if light off.	See Appendix.
	TOKEN	Flicker check	Light off means abnormal operation (Duplicated station or cable error).	See Appendix.
	TX/RX	Flicker check	Light off means abnormal operation (Duplicated station or cable error).	See Appendix.
	FAULT	Light off check	Intermittent flash means communication error (Cable connection error, or terminal resistance connection error).	See Appendix.
	SYS FAULT	Light off check	Regular flash means system error (Error code is displayed in LED).	See Appendix.

3) **Communication module of Mnet**

Items of routine check are as following table :

Table 8.4.1(C) Items of routine check

Items to be checked		Contents	Criteria of decision	Action to take
Cable connection status		Release of cable	Shall not be any release.	Tighten the cable.
Connection status of terminal block		Release of terminal screw	Shall not be any release.	Tighten screw of terminal.
		Gap between compression terminals	Shall be relevant gap.	Correct.
LED indication	RUN	Light on check	Light on (Lights-out means abnormal).	See Appendix.
	TX	Light on check in RUN status	Light on (Lights-out means abnormal).	See Appendix.
	RX	Light on check in RUN status	Light on (Lights-out means abnormal).	See Appendix.
	IN-RING	Light on/light off check	Light on (Light off means abnormal) Lights when cable is connected with other station.	See Appendix.
	FAULT	Light off check	Light off (Light on or flash error).	See Appendix.

8.4.2 Regular check

Check following items once or twice per six months, and perform relevant action to take.

Table 8.4.2 Items of regular check

Items to be checked		How to check	Criteria of decision	Action to take
Ambient environment	Ambient temperature	Check using thermometer and hydrometer.	0~55℃	Arrangement by general specification (If it is used in a class, environment of class is used as standard).
	Ambient humidity		5~95%RH	
	Ambient pollution	Check corrosive gas.	Shall not be any corrosive gas.	
Module status	Release, shaking	Shake communication module.	Shall not be any release or shaking.	Tighten the screw.
	Attachment of dust and foreign matter	Visual inspection.	Shall not be any attachment.	Remove
Connection status	Release of terminal screw	Tighten using driver.	Shall not be any release.	Tighten.
	Gap between compression terminals	Visual inspection.	Shall be relevant gap.	Correct.
	Release of connector	Visual inspection.	Shall not be any release.	Fix the connector Tighten the screw.
Power voltage check		Check voltage between terminal.	AC 85~132V AC 170~264V	Change supplied power.

Chapter 9 Troubleshooting

This chapter explains all of error contents which may occurs during system management, cause detection, and how to take action. If error occurred in communication module, error contents are displayed through LED of communication module. At this time, user can read error indication(Ex. FMM_06) according to appropriate LED status from Appendix, and perform troubleshooting according to error code(Ex. E00-01) from error indication in this chapter.

9.1 Abnormal operations

Table 9.1(A) H/W related error of communication module

Error code	Error indication (See LED contents of Appendix)	Error contents
E00-01	FMM_06 ~ FMM_10 FMM_24 ~ FMM_27 FSM_05 ~ FSM_10 FSM_32 MCM_06 ~ MCM_09	Hardware self diagnosis error among LED indication of each module.
E00-02	FMM_11 ~ FMM_13 MCM_11	Interface diagnosis error with PLC among LED indication of each module.
E00-03	FOU_41, FOU_42, FOU_43, FOU_44 FOU_51, FOU_52, FOU_61, FOU_62	Power and hardware error of FOU group occurred.
E00-04	FSM_08 ~ FSM_10	Initialization of I/O and special module in slave group.

Table 9.1(B) Abnormal communication status of communication module

Error code	Error indication	Error contents
E01-01	FMM_16 ~ FMM_21 FSM_13 ~ FSM_16 FSM_31 ~ FSM_33	Communication error in master and slave group of Fnet (Communication is not made well).
E01-02	MCM_12 ~ MCM_14	Communication error in communication module group of Mnet (Communication is not made well).
E01-03	FOU_41, FOU_42, FOU_43 FOU_51, FOU_61	Communication error in FOU group of Fnet (Communication is not made well).

Table 9.1(C) Abnormal interface operation of PLC of communication

Error code	Error indication	Error contents
E02-01	FMM_22, FMM_23 MCM_11	Interface with PLC in master and communication module group is not made well.
E02-02	FSM_08 ~ FSM_10	Interface error with I/O module in slave group of Fnet.

9. Troubleshooting

Table 9.1(D) Abnormal operation of *high speed link* function

Error code	Error indication	Error contents
E03-01	<i>High speed link</i> parameter error in error status dialog box.	This error happens when <i>high speed link</i> parameter is not set well or not set at all, or it is broken, after setting link-enable of on-line.
E03-02	<i>High speed link</i> communication is not performed.	When communication is not made well even though <i>high speed link</i> is normal after setting link-enable.
E03-03	Contacts of <code>_HSxRLNK</code> and <code>_HSxTRX</code> are not set to 'On' during <i>high speed link</i> .	When <code>_HSxRLNK</code> is not set to 'On' even though <i>high speed link</i> parameter is normal after setting link-enable.
E03-04	Contacts of <code>_HSxTRBL</code> , etc. are set to On during <i>high speed link</i> .	After setting link-enable and <code>_HSxRLNK</code> of <i>high speed link</i> is set to 'On', when <code>HSxLTRBL</code> is set to 'On' by the problem of PLC and communication in normal status.

Table 9.1(E) Abnormal operation of communication command service function

Error code	Error indication	Error contents
E04-01	When service is performed by Fnet, ERR contact of communication command is set to 'On' and the value of status is not '0'.	ERR of communication command is set to 'On', or NDR/ERR of communication command doesn't become '1'.
E04-02	When service is performed by Mnet, ERR contact of communication command is set to 'On' and the value of status is not '0'.	ERR of communication command is set to 'On', or NDR/ERR of communication command doesn't become '1'.

Table 9.1(F) Abnormal operation of GMWIN communication service function

Error code	Error indication	Error contents
E05-01	Message of [No response] occurs during remote connection request.	RS-232C cable is not connected between GMWIN and PLC or the power of PLC is off.
E05-02	When other error message occurred during remote connection request.	Service is not performed well because request is not relevant.

9.2 Troubleshooting by each error code

9.2.1 Error code E00-01 : Hardware error

E00-03 : Hardware error of option module

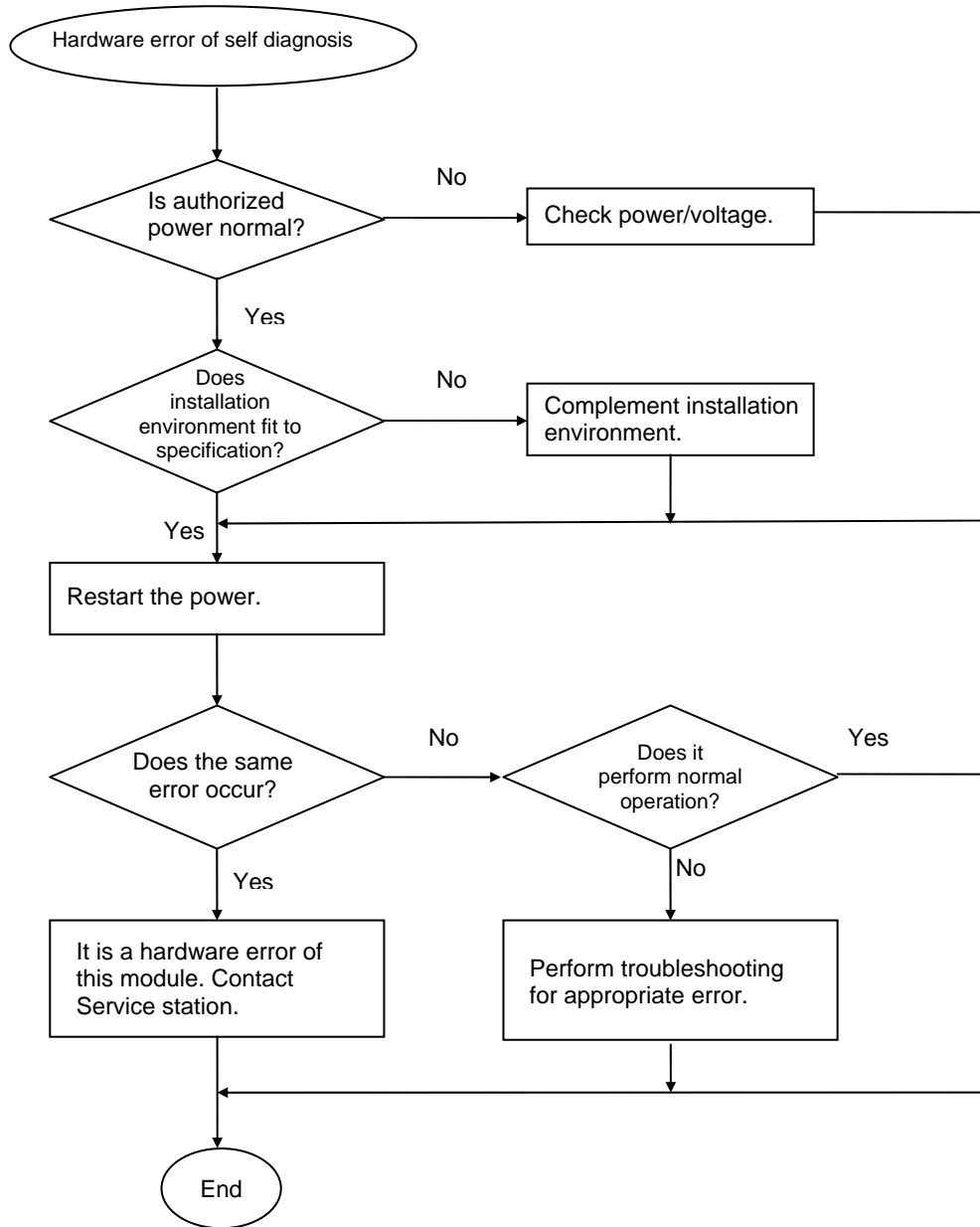

9.2.2 Error code E00-02 : Interface error

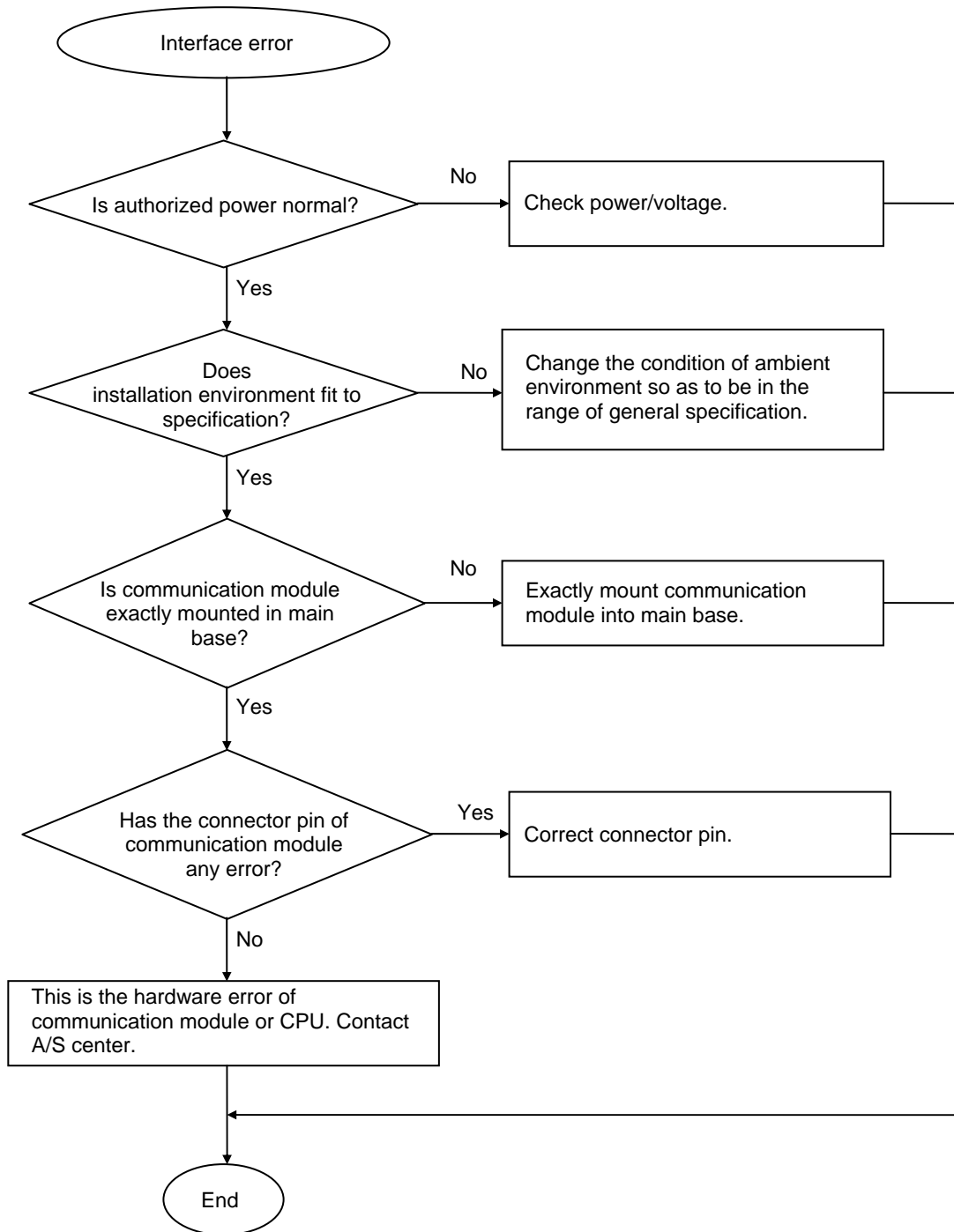

9.2.3 Error code E00-04 : I/O initialization error of FSM(Fieldbus Slave Module)

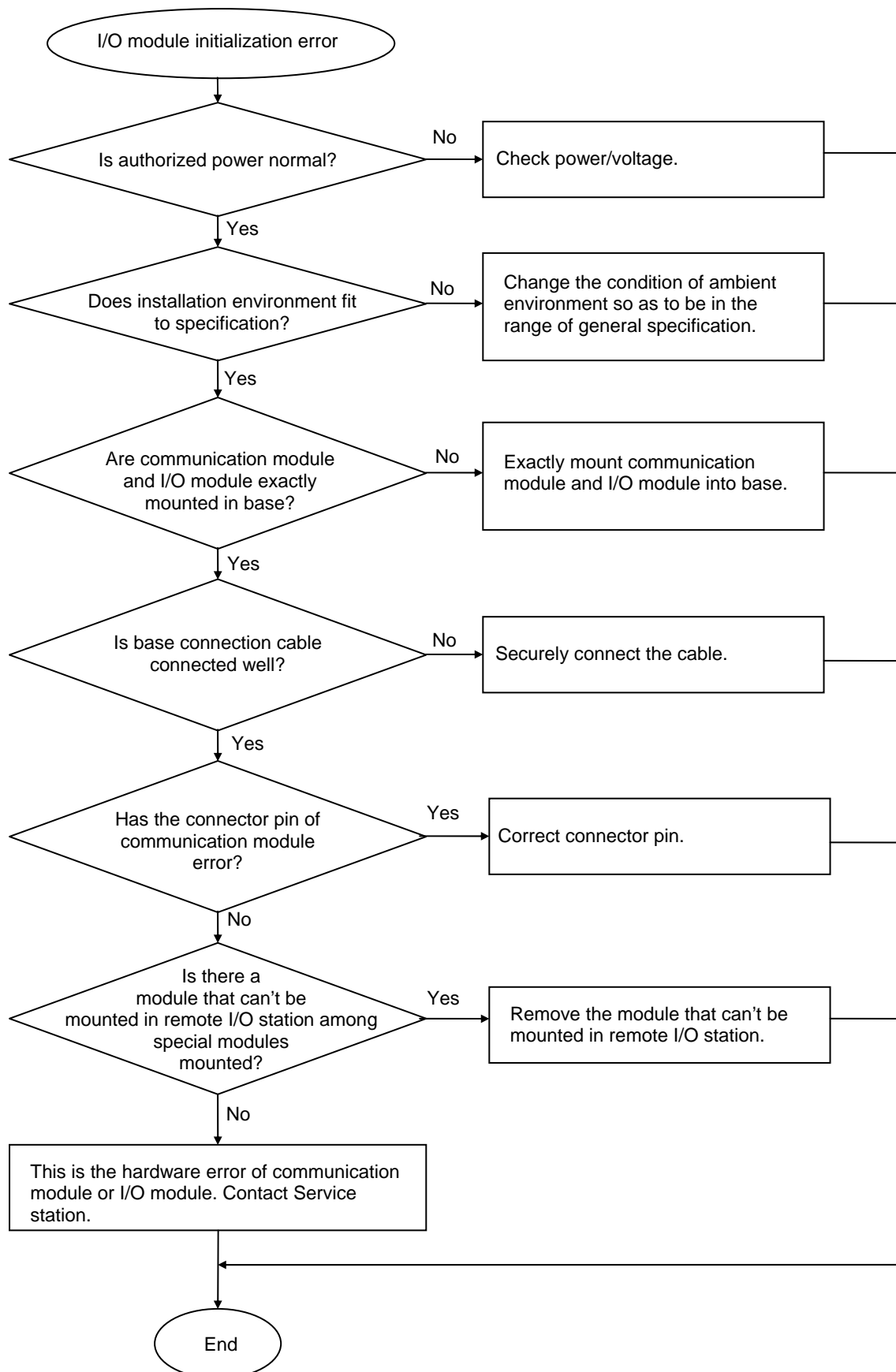

**9.2.4 Error code E01-01 : Communication failure in Fnet
E01-02 : Communication failure in Mnet
E01-03 : Communication failure in FOU group**

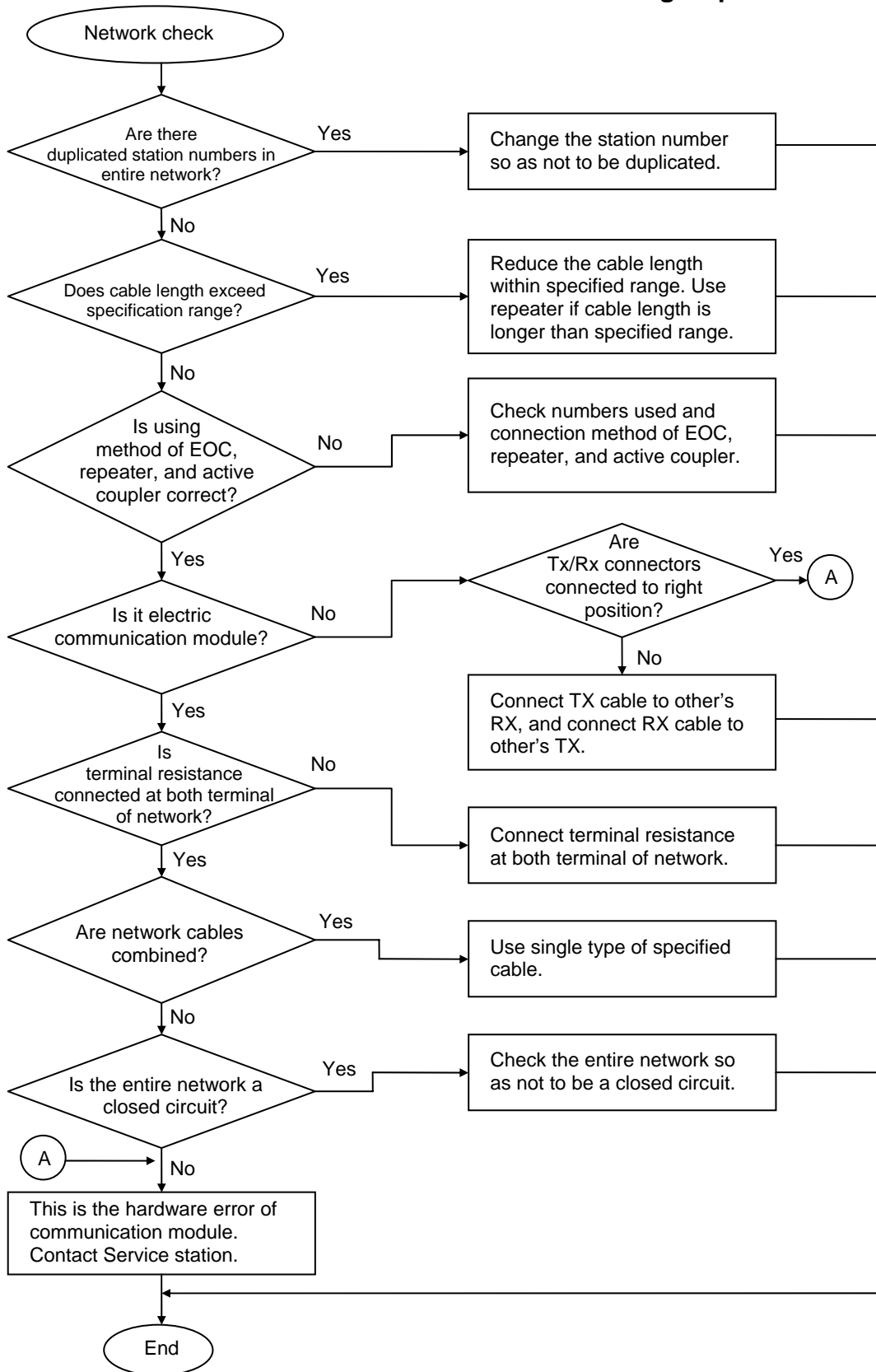

9.2.5 Error code E02-01 : PLC interface error during operation

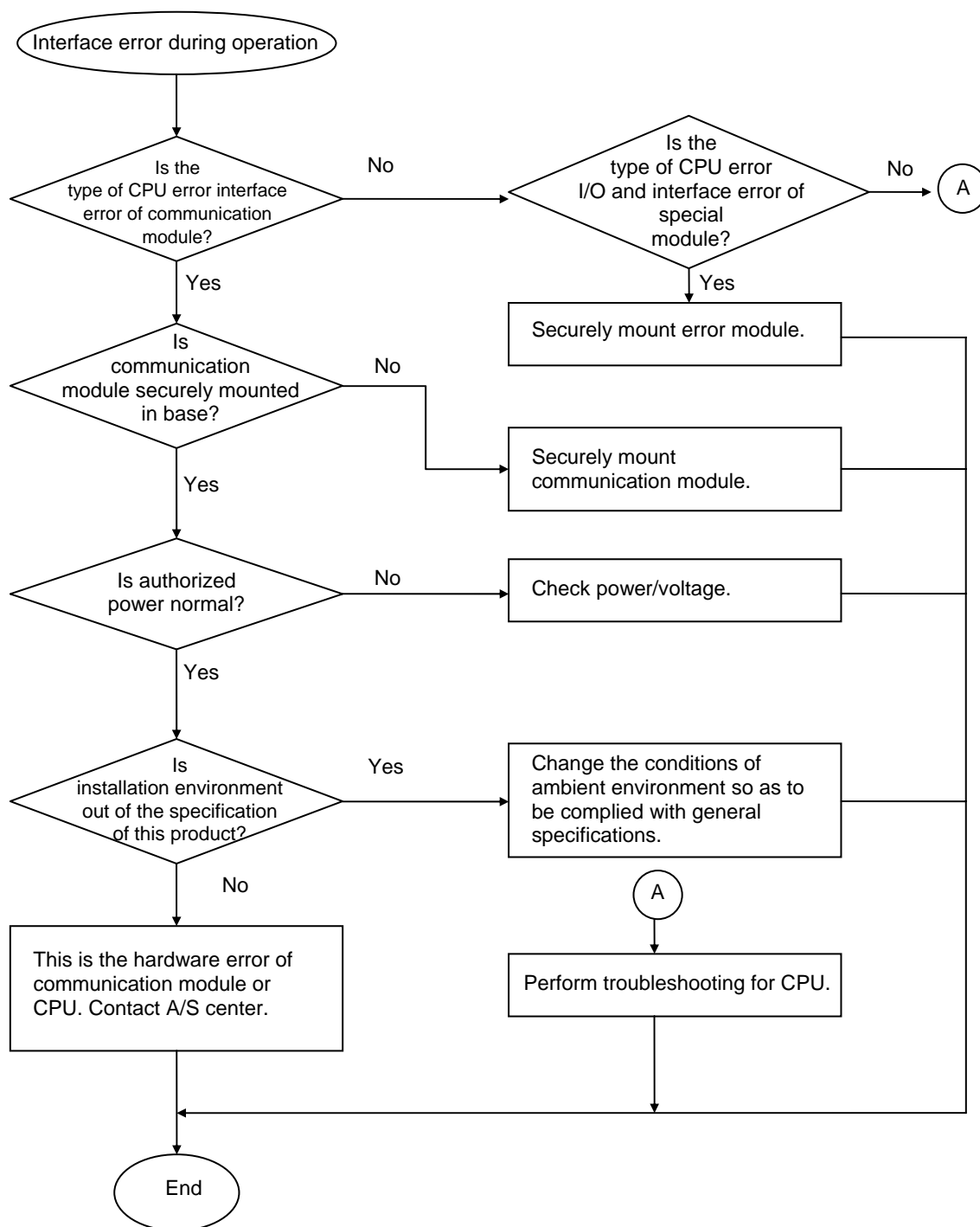

9.2.6 Error code E02-02 : Slave mounting and writing interface error during operation

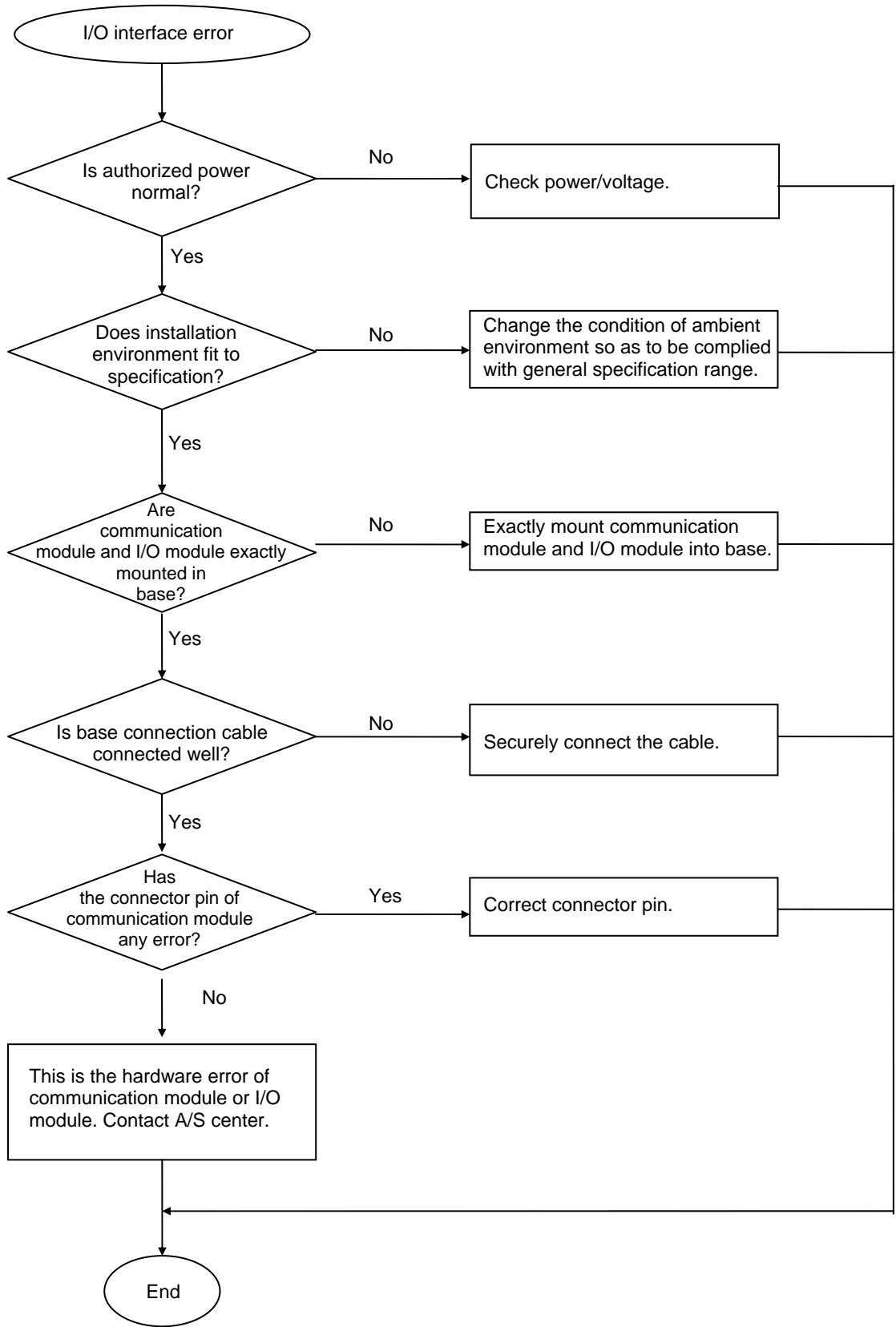

9.2.7 Error code E03-01 : High speed link parameter error

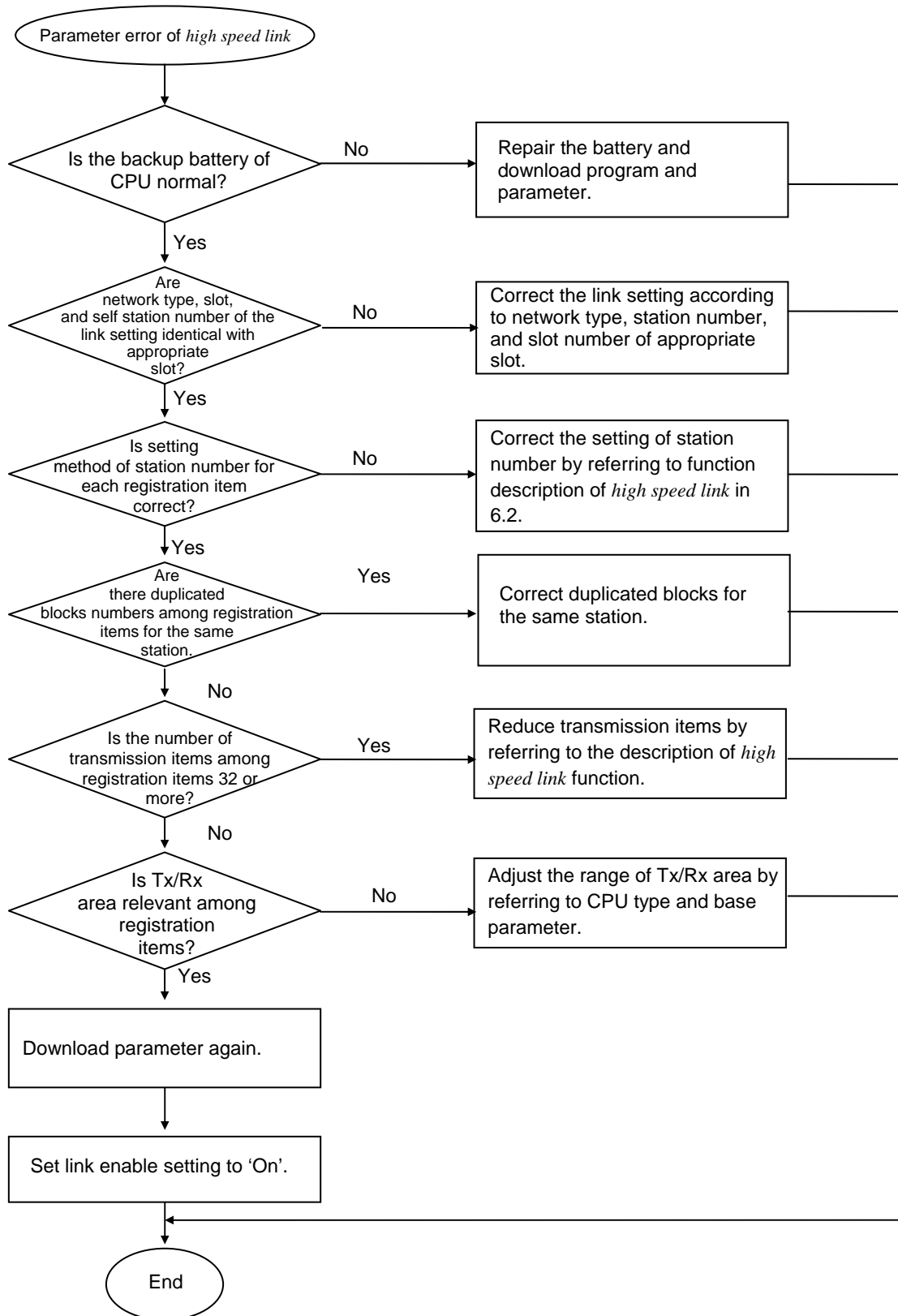

9.2.8 Error code E03-02 : High speed link not run

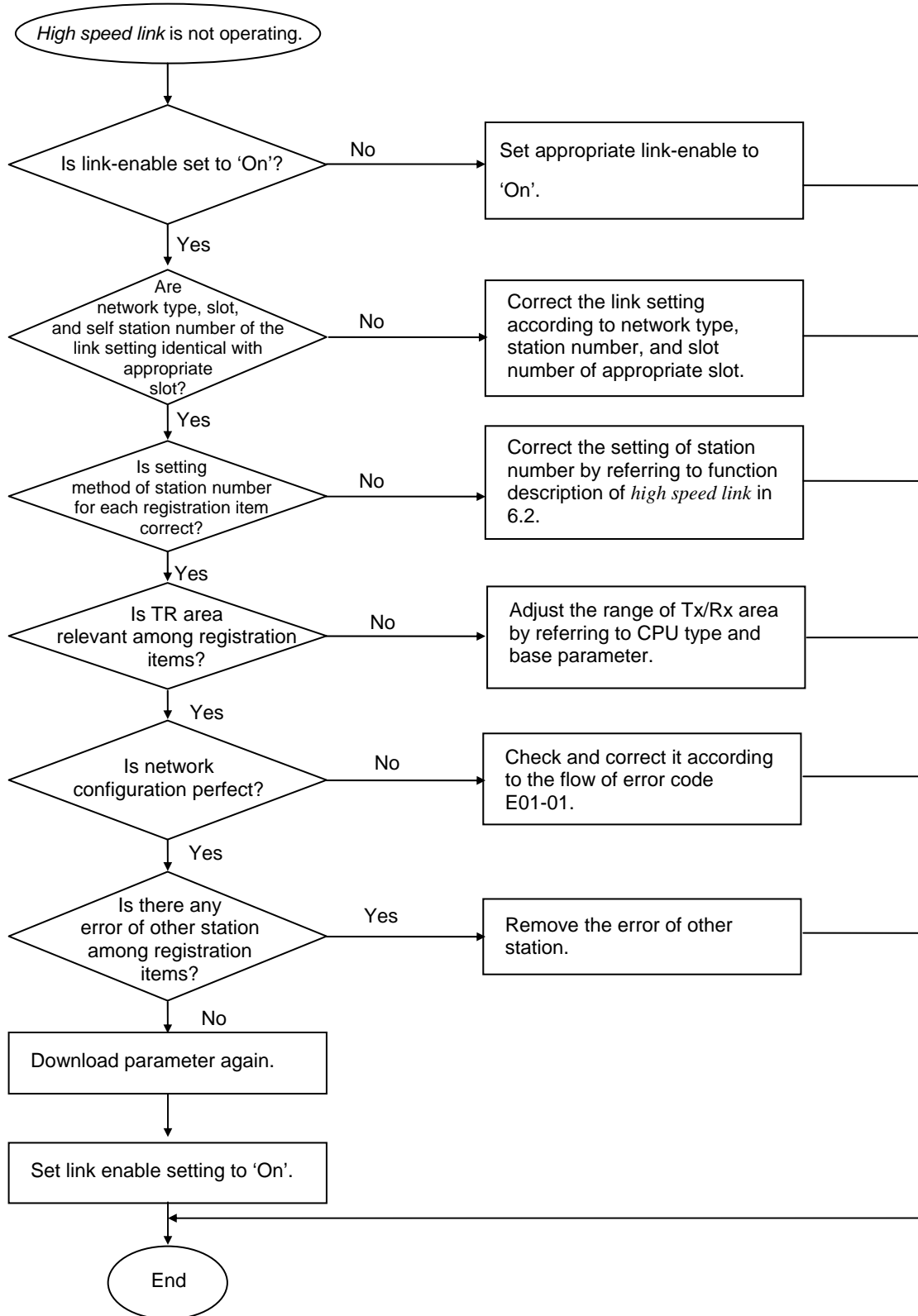

9.2.9 Error code E03-03 : Run link contact of *high speed link* not ON

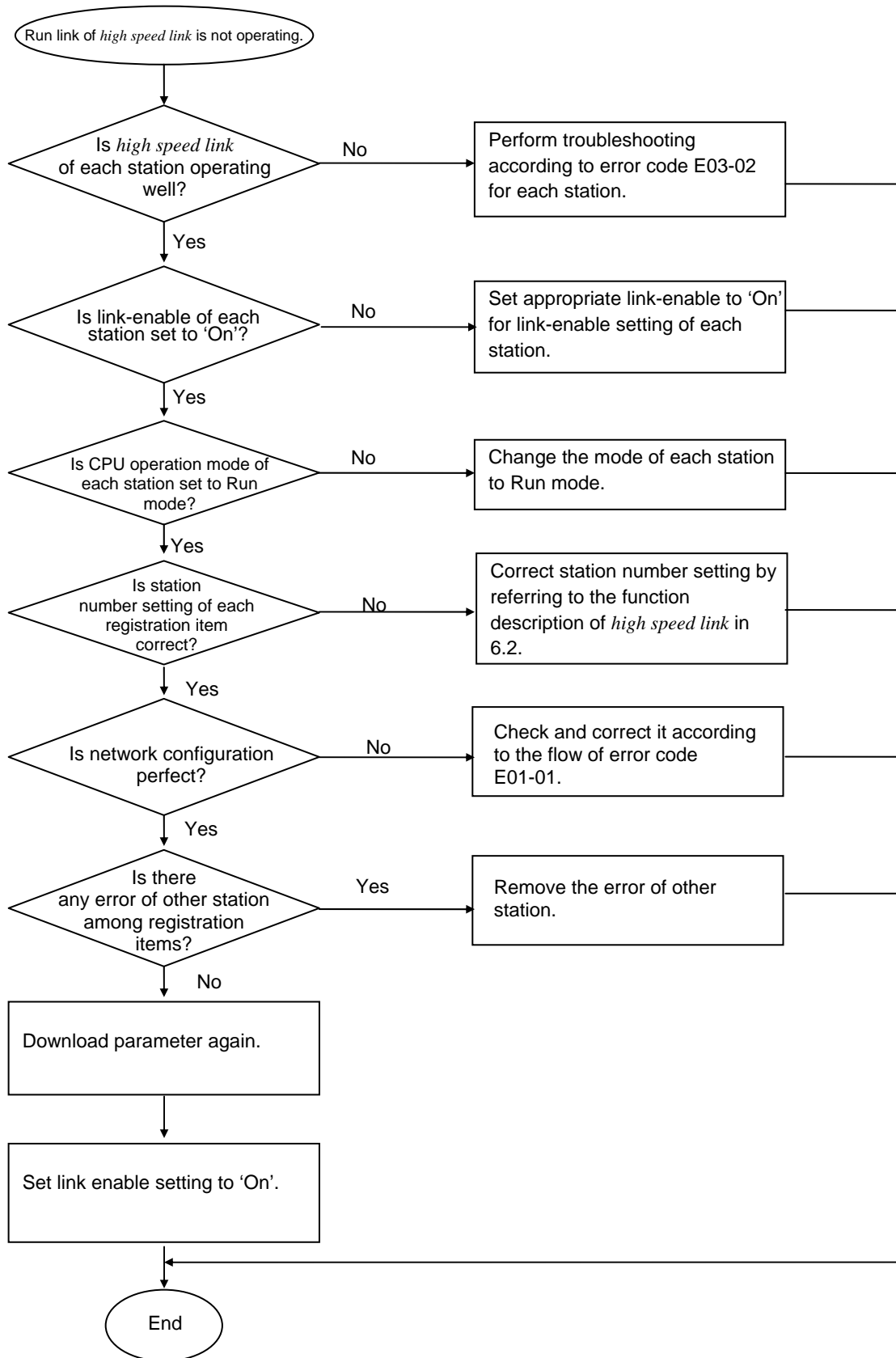

9.2.10 Error code E03-04 : Trouble contact of *high speed link* ON

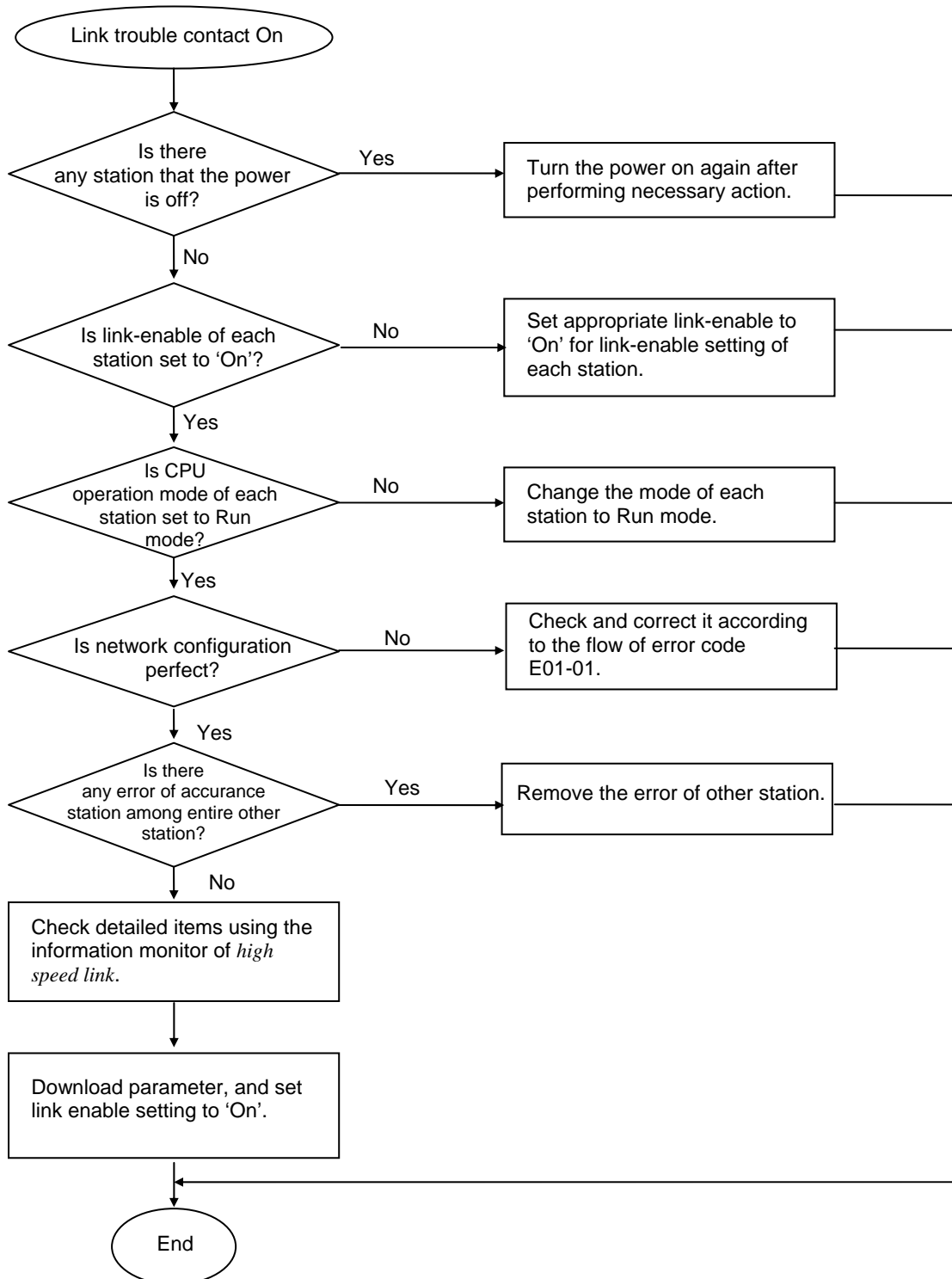

**9.2.11 Error code E04-01 : Execution error of Fnet communication command
E04-02 : Execution error of Mnet communication command**

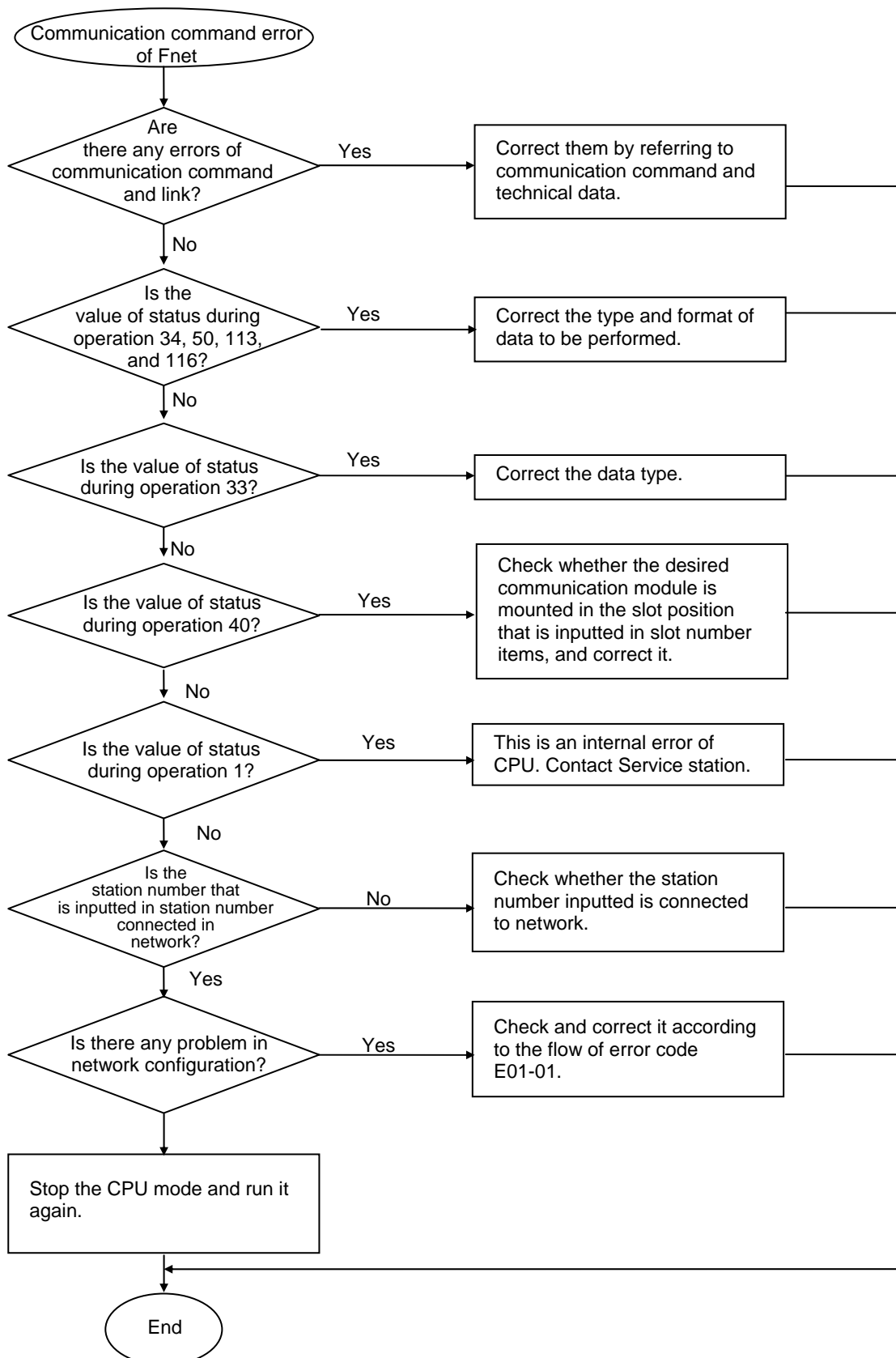

9.2.12 Error code E05-01 : Time out error in GMWIN communication

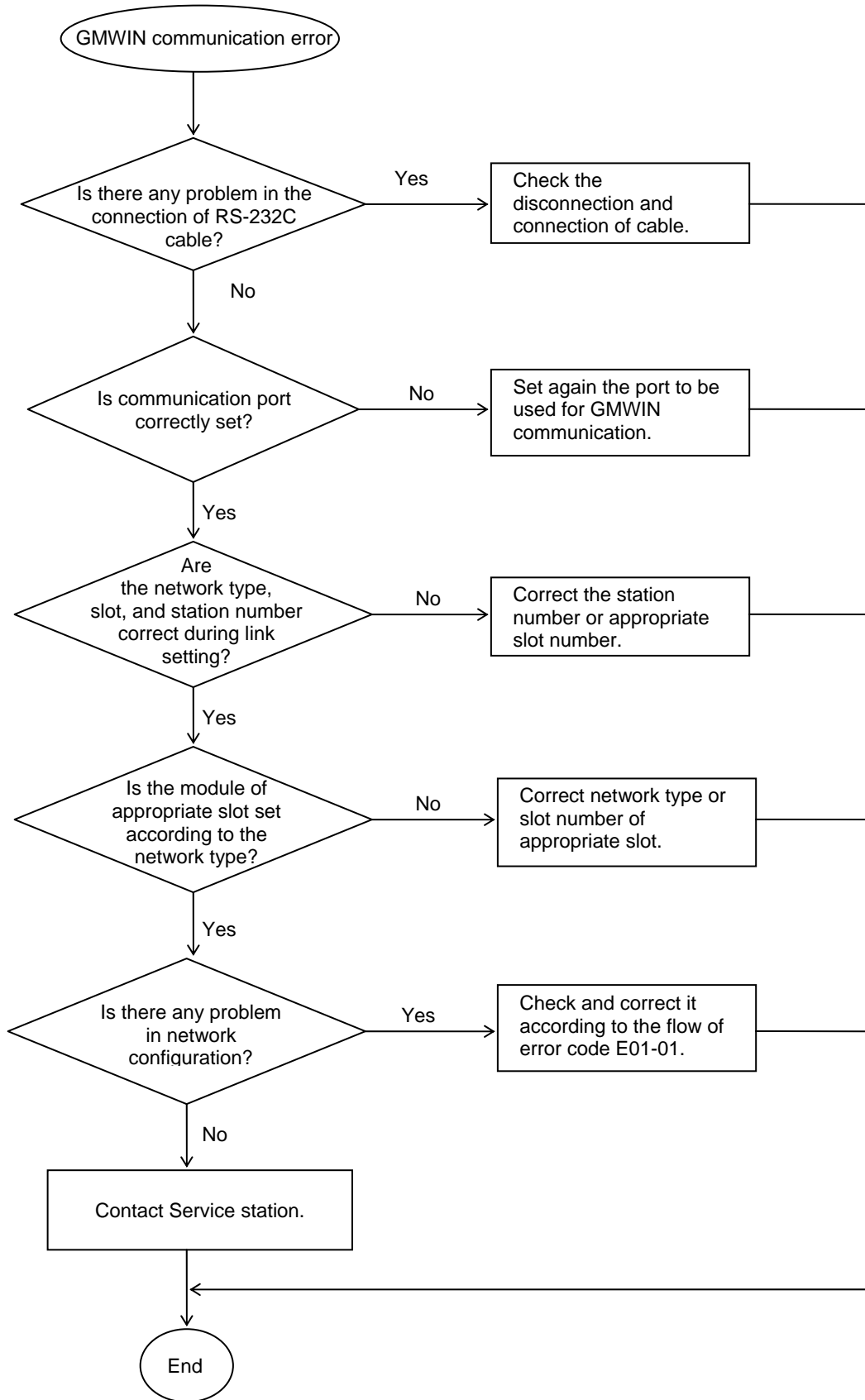

9.2.13 Error code E05-02 : Internal error of Fnet/Mnet GMWIN communication

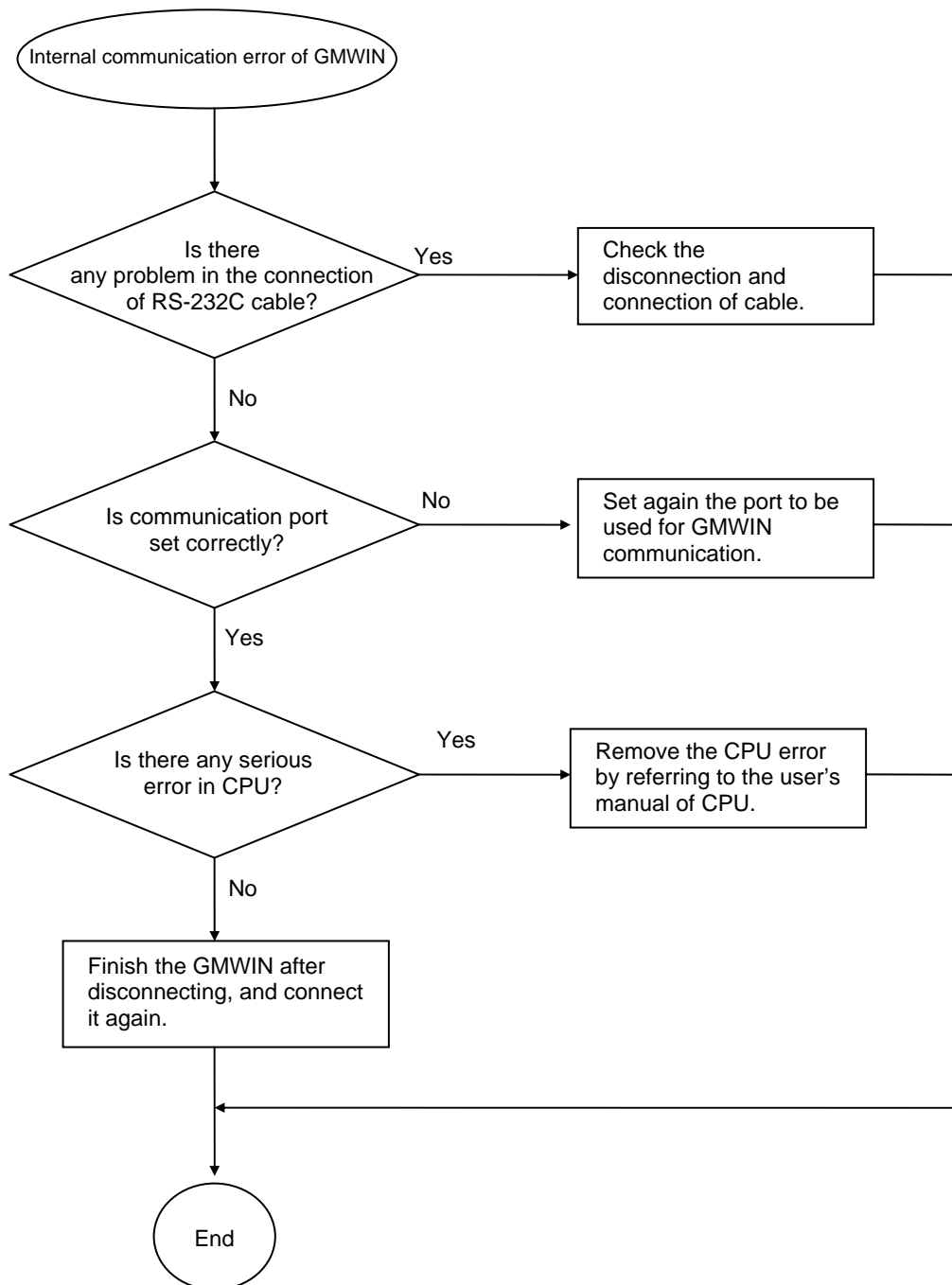

Appendix

A1 LED Specifications

A1.1 LED specifications of Fnet master module

1) Units to be applied :

G3L-FUEA, G3L-FUOA, G4L-FUEA,
G5L-FUEA, G0L-FUEA

<input type="radio"/> RUN
<input type="radio"/> LAS
<input type="radio"/> TOKEN
<input type="radio"/> TX/RX
<input type="radio"/> FAULT

G6L-FUEA

RUN	<input type="radio"/>
LAS	<input type="radio"/>
TOKEN	<input type="radio"/>
TX/RX	<input type="radio"/>
	<input type="radio"/> FAULT

2) LED indication spec.

- (1) RUN : Indicates that PLC CPU module and interface is proceeding actively.
- On : PLC and interface normal
 - Off : Interface abnormal, or interface stopped

When normal, it seems to be 'On', but, because the flash cycle changes according to PLC scan, it may seem to be 'Off' in visual as it becomes 'On' at intervals or by once for 1~2 sec. when PLC User Program Scan is long(200ms or more), or communication module of 2 or more has been mounted on PLC so that many data may be exchanged. This is not abnormal operation of communication module, but because data processing speed has become late due to many communication quantity.

- (2) LAS : The LED of the station that assign tokens to each station becomes On in order to perform data Tx/Rx with communication module connected. Among many communication stations, the communication module that is firstly powered on has LAS, and among all stations connected via single network, LAS LED of only one station becomes On.

- On : Being in performing function with Link Active Scheduler(LAS).
- Off : Being in performing function with Link Master(LM).

- (3) TOKEN : Indicates that module is sending transmission data by assigning circulation token from LAS. If network has many stations connected, and each station has many data, LED flashes at late speed.

- On : Currently possesses circulation token.
- Off : Does not possess token.

(4) TX/RX : Indicates that self station is receiving data from other station or sending self data.

- On : Indicates that it is sending or receiving.
- Off : Indicates that there is no Tx/Rx frame.

(5) FAULT : This is a LED indicating whether error occurred in communication module, which becomes 'Off' during normal operation, and flashes at 1 sec. interval when error that normal operation is impossible occurs. The type of error is indicated through 5 LEDs of LED0(RUN)~LED4(FAULT).

☞ If it flashes at intervals, it means that there is a error in communication module, communication cable, terminal resistance, connection status, duplicated station, and the other. Thus, check the followings :

- ① Is terminal resistance correctly connected?
- ② Is cable securely connected?
- ③ Is communication cable shield line connected with connector?(must be connected)
- ④ Do cable and terminal resistance fit to the specifications?
- ⑤ Is total length of cable 750m or less?
- ⑥ Isn't there any duplicated station?

Table A.1.1 describes LED indication contents of Fnet master module.

Table A.1.1 LED indication contents of Fnet master group

Segment	Error type	LED status	Error contents
FMM_00	During power on	● ○ ○ ○ ○	Being in self diagnosis of internal memory 1 in this module
FMM_01		○ ● ○ ○ ○	Being in self diagnosis of internal memory 2 in this module
FMM_02		○ ○ ● ○ ○	Being in self diagnosis of communication
FMM_03		○ ○ ○ ● ○	Being in diagnosis of CPU and interface
FMM_04	Normal communication	● ○ ● ● ○	Module is not LAS.
FMM_05		● ● ● ● ○	Module is LAS.
FMM_06	Hardware error	● ○ ○ ○ ●	Error in self diagnosis of internal memory 1
FMM_07		○ ○ ○ ● ●	Error in self diagnosis of internal memory 2
FMM_08		○ ○ ● ○ ●	Error in self diagnosis of communication
FMM_09		○ ○ ● ● ●	Error in diagnosis of interface chip
FMM_10		○ ● ○ ○ ●	Error in diagnosis of interface RAM
FMM_11		○ ● ○ ● ●	Error 1 in diagnosis of CPU and interface
FMM_12		○ ● ● ○ ●	Error 2 in diagnosis of CPU and interface
FMM_13		○ ● ● ● ●	Error 3 in diagnosis of CPU and interface
FMM_14	System operation error	● ○ ○ ○ ●	System error during operation
FMM_15		● ○ ○ ● ●	
FMM_16	Abnormal communication	● ● ○ ○ ●	Error in configuration of network
FMM_17		● ● ○ ● ●	Repeated station No., abnormal terminal resistance
FMM_18		● ● ● ● ●	Cable cut off/Short
FMM_19		● ● ○ ● ●	Specified length of cable is not proper or hardware error of this module
FMM_20		● ○ ● ● ●	
FMM_21		● ○ ○ ○ ●	Error in configuration of network
FMM_22	Interface error	○ ● ● ● ○	Interface error(stopped) for LAS
FMM_23		○ ○ ● ● ○	Interface error(stopped) for not LAS
FMM_24	Not restorable error	● ● ● ● ●	Hardware error of communication module
FMM_25		● ○ ○ ○ ○	
FMM_26		○ ○ ○ ○ ○	
FMM_27		○ ○ ○ ○ ●	

※ LED position follows the sequence of signal RUN, LAS, TOKEN, TX/RX, and FAULT from left side.

- Light on
- Light off
- Flash at 1 sec. interval
- Irregular non-interval flash or Off
- Irregular non-interval flash

A1.2 LED specifications of slave module

1) Units to be applied : G3L-RBEA, G3L-RBOA, G4L-RBEA

2) LED position

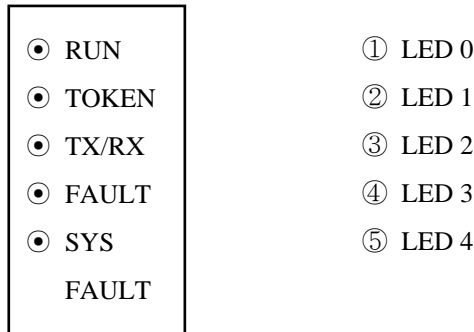

3) LED indication spec.

(1) RUN(LED 0) : Indicates RUN status, and means that I/O inspection and I/O refresh operation is normally being operated. This becomes off when power error of extension base, or error occurrence during special module access or I/O refresh.

- On : Indicates being in normal operation of slave.
- Off : Abnormal operation of slave.

(2) TOKEN(LED 1) : Indicates that module is sending transmission self data by assigning circulation token from LAS. This flashes during normal operation. If network has many stations connected, and each station has many data, LED flashes at slow speed.

- On : Currently possesses circulation token.
- Off : Does not possess token.

(3) TX/RX(LED 2) : Indicates that self station is receiving data from other station or sending self data.

- On : Indicates that it is sending or receiving.
- Off : Indicates that there is no Tx/Rx frame.

(4) FAULT(LED 3)

- Flash : Flashes when communication error/service error occur in link module.
- Off : Indicates being in normal operation.

☞ If it flashes at intervals, it means that there is an error in communication cable. Thus, check the followings :

- ① Is terminal resistance correctly connected?
 - ② Is cable securely connected?
 - ③ Is communication cable shield line connected with connector body?(must be connected)
 - ④ Do cable and terminal resistance fit to the specifications?
 - ⑤ Is total length of cable 750m or less?
 - ⑥ Isn't there any duplicated station?
- (5) SYS FAULT(LED 4) : This is a LED indicating error occurrence or not in communication module, which becomes 'Off' during normal operation and flashes at 1 sec. interval when error that normal operation is impossible occurs. The type of error is indicated through 5 LEDs of LED0~LED4.

Table A.1.2 LED indication specifications of slave group

Segment	Error type	LED status	Error contents
FSM_00	During power on	● ○ ○ ○ ○	Being in self diagnosis of internal memory 1 in this module
FSM_01		○ ● ○ ○ ○	Being in self diagnosis of internal memory 2 in this module
FSM_02		○ ○ ● ○ ○	Being in self diagnosis of communication
FSM_03		○ ○ ○ ● ○	Being in self diagnosis of special module interface RAM memory
FSM_04	Normal communication	● ● ● ○ ○	When module communication is normal.
FSM_05	Hardware error	○ ○ ○ ○ ●	Error in self diagnosis of internal memory 1
FSM_06		○ ○ ○ ● ●	Error in self diagnosis of internal memory 2
FSM_07		○ ○ ● ○ ●	Error in self diagnosis of communication
FSM_08		○ ○ ● ● ●	Error in writing/reading special module
FSM_09		○ ● ○ ○ ●	Error in writing/reading I/O module
FSM_10		○ ● ○ ● ●	Error in mounting module, Fuse problem
FSM_11	System operation error	● ○ ○ ○ ●	System error during operation
FSM_12		● ○ ○ ● ●	
FSM_13	Abnormal communication	● ● ● ● ○	Cable cut off, short
FSM_14		● ● ○ ● ○	Specified length of cable is not proper
FSM_15		● ○ ○ ● ○	Hardware error of this module
FSM_16		○ ○ ○ ○ ○	Error in configuration of network
FSM_17	Not restorable error	● ● ● ● ●	Hardware error of communication module
FSM_18		● ○ ● ○ ●	
FSM_19		○ ○ ○ ○ ○	
FSM_20		○ ○ ○ ○ ●	

※ LED position follows the sequence of signal RUN, TOKEN, TX/RX, FAULT, and SYS FAULT from left side.

- Light on
- Light off
- Flash at 1 sec. interval
- Irregular non-interval flash or Off
- Irregular non-interval flash

A1.3 LED specifications of stand-alone type remote module(G0L-SMQA/SMIA/SMHA)

Segment	Error type	LED status PWR/ONTX/ERR	Error contents
FSM_30	Being in normal communication	● ● ○	Being in normal communication
FSM_31	Abnormal communication	● ● ●	Bad communication status
FSM_32	System error	● ○ ●	Self diagnosis error of communication or system error during operation
FSM_33	No communication	● ○ ○	Not communicates with other station of network
FSM_34	Power off	○ ○ ○	Power off status

A1.4 LED specifications of repeater module(G0L-FREA)

Segment	Error type	LED status PWR/TRTA/TRXB	Error contents
FOU_40	Being in normal communication	● ● ●	Being in normal communication
FOU_41	Abnormal communication	● ● ○	Unstable status in side A communication
FOU_42		● ○ ●	Unstable status in side B communication
FOU_43	No communication	● ○ ○	Not communicates with other station of network
FOU_44	Power off	○ ○ ○	Power off status

A1.5 LED specifications of electric, optical signal switching module(G0L-FOEA)

Segment	Error type	LED status PWR/TRX	Error contents
FOU_50	Being in normal communication	● ●	Being in normal communication
FOU_51	Abnormal communication	● ○	Network not communicates
FOU_52	Power off	○ ○	Power off status

A1.6 LED specifications of active coupler module(optical signal distributor)

Segment	Error type	LED status PWR/TRX	Error contents
FOU_60	Being in normal communication	● ●	Being in normal communication
FOU_61	Abnormal communication	● ○	Network not communicates
FOU_62	Power off	○ ○	Power off status

- Light on
- Light off
- Flash at 1 sec. interval
- Irregular non-interval flash or Off
- Irregular non-interval flash

A1.7 LED specifications of Mnet communication module

1) Units to be applied : G3L-MUEA, G0L-MUEA

2) LED position

● RUN	① LED 0
● TX	② LED 1
● RX	③ LED 2
● IN-RING	④ LED 3
● FAULT	⑤ LED 4

3) LED indication spec.

(1) RUN(LED 0)

- Light on when CPU module and interface are normal.
- Light off when interface is abnormal or stopped.

(2) TX(LED 1)

- Light on when communication module is sending data or token.
- Light off when it does not have any token.

(3) RX(LED 2)

- Light on when communication module is receiving data or token.

(4) IN-RING(LED 3)

- Light on when one or more communication modules are connected via cable and communicate each other.
- Flashes when only one communication module operates.

(5) FAULT(LED 4)

- Flashes when CPU error is detected : RUN LED lights off.
- Flashes when interface RAM address error occurs : RUN LED lights on.
- Flashes when error that can not normally operates occurs in communication module.
- Light off when normal operation.

Table A1.7 LED specifications of Mnet MCM group

Segment	Error type	LED status	Error contents
MCM_00	During power on	○ ○ ○ ○ ○	Inspection on inside of CPU and 256k RAM after communication module H/W reset.
MCM_01		● ○ ○ ○ ●	Communication module 256k RAM inspection normal. Inspection on communication module modem and TBC.
MCM_02		● ○ ○ ● ●	Inspection on communication module modem and TBC normal. Inspection on IC access for communication and interface RAM of communication module side.
MCM_03		● ○ ○ ● ○	Inspection on interface RAM of communication module side normal. Inspection ready on interface RAM of CPU side and interface RAM initialization data inspection.
MCM_04	During normal operation	● ● ● ● ○	Being in communicating with various station in network.
MCM_05		● ● ● ● ○	Being in communicating by itself only.
MCM_06	Hardware error when initialization	● ○ ○ ○ ●	Error when system memory test.
MCM_07		● ○ ○ ● ●	Modem test error (when initialization)
MCM_08		● ○ ○ ● ●	TBC test error (when initialization)
MCM_09		● ○ ○ ● ○	Interface RAM test error (when initialization)
MCM_10	Error occurrence during operation	● ○ ○ ○ ●	Interface RAM access error
MCM_11		○ ○ ○ ○ ○	Error of IC for interface RAM, and CPU module error
MCM_12		● ● ○ ○ ○	F-connector error(during operation) Transformer error
MCM_13		● ○ ● ○ ○	Modem error(during operation), Clock error for modem
MCM_14		● ○ ● ● ○	Modem error(during operation), Clock error for modem

※ LED position follows the sequence of signal RUN, TX, RX, IN-RING, and FAULT from left side.

● Light on

○ Light off

● Irregular non-interval flash

A2 Communication module setting in the Fnet/Mnet PC

- 1) **Units to be applied : G0L-FUEA/G0L-MUEA**
- 2) **Hardware setting :** For PC communication module, Fnet module(G0L-FUEA) uses 32kbytes, Mnet module(G0L-MUEA) 64kbytes. Therefore, user must set to I/O address and memory base address in order that memory area may not overlap with other modules mounted on PC.
 ※ I/O address(port) size is 32 bytes, and memory size is 16 kbytes.

Table A2.1 Port/memory address map

Switch value (HEX)	Fnet module(G0L-FUEA)		Mnet module(G0L-MUEA)		Remark
	I/O Address	Memory Base	I/O Address	Memory Base	
0	3E0	FC00	3E0	FC00	*When factory default, I/O address is set to No.5(340), and memory base is set to No.D(C800).
1	3C0	F800	3C0	F800	
2	3A0	F400	3A0	F400	
3	380	F000	380	F000	
4	360	EC00	360	EC00	
5	340*	E800	340*	E800	
6	320	E400	320	E400	
7	300	E000	300	E000	
8	2E0	DC00	2E0	DC00	
9	2C0	D800	2C0	D800	
A	2A0	D400	2A0	D400	
B	280	D000	280	D000	
C	260	CC00	260	CC00	
D	240	C800*	240	C800*	
E	220	C400	220	C400	
F	200	C000	200	C000	

Remark

1. When I/O address and memory address overlap with an area used in other driver, PC will down. So set it in order not to overlap.
2. It is recommended that memory address is used within C800-DBFF address.
3. To use computer memory not as extended or expanded area but as this module's area, set to DEVICE=C:\WINDOWS\EMM386.EXE NOEMS X=C800-DBFF(when setting address to No.D, C800) in CONFIG.SYS.

A3 STATUS code value and description for *Function block*

A3.1 Error received from communication module

Error No. (Decimal)	Description
0	OK(Success : No error)
1	Physical layer error of link side(Tx/Rx impossible) – Cause of self error and other station's power off, other station No. writing error, and failure, etc.
3	There is no identifier of <i>function block</i> to be received in communication channel. – Value not used in our company.
4	Data type mismatch
5	Reset received from other station – Value not used in our company.
6	Communication command of other station not ready – Value not used in our company.
7	Device state of remote station in wrong state – Value not used in our company.
8	Access denied to remote object
9	Communication commands of other station unable to process due to receiver overrun – Value not used in our company.
10	Time out for response waiting – When response has not been received from other station within a given time.
11	Structure error
12	Abort(Local/Remote) – Disconnected by serious error
13	Reject(Local/Remote) – Type unfitted to MMS, error caused by noise.
14	Communication channel setting error(Connect/Disconnect) – Error related to logical communication channel setting required during communication with service for PI/DOMAIN/GEN and other communication module(for Mini-MAP only)
15	High speed communication and connection service error
33	Cannot find variable identifier – Not identified in the range of access variable
34	Address error – Error of structure and range specified in specifications of communication module
50	Response error – When response not received as required or other station's CPU error

113	Object access unsupported – Out of VMD specific and symbolic address or exceeded max. value of data length
187	Received via another error code than specified code(Other company's communication code value) – Receiving another error code value than specified.

A3.2 STATUS values indicated in CPU

1) Error processed within communication commands

Error No. (Decimal)	Description
16	When position of computer communication module is wrongly specified.
17	Initialization error of communication module mounted in SLOT_NO
18	Input parameter setting error
19	Variable length error
20	Wrong response receiving from other station
21	When no response received from computer communication module (Out of waiting time - Time out)

2) Status error related to remote(FSM) Function block

Error NO. (Decimal)	Description
128	FSM power error
129	BASE(Rack) No. error
130	Slot No. error
131	Module information error
132	Data range error(Invalid range)
133	Data type mismatch
136	Access failure(BUS access error)
137	Another error than specified code

A4 Outward dimension

A4.1 For mounting GM1/2/3

- 1) Fnet units to be applied

G3L-FUEA, G3L-FUOA, G3L-RBEA, G3L-RBOA

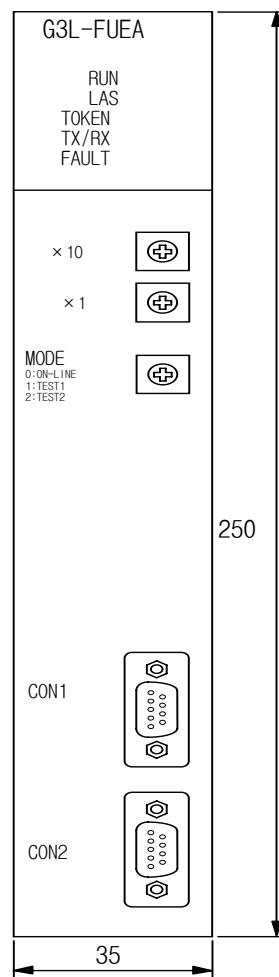
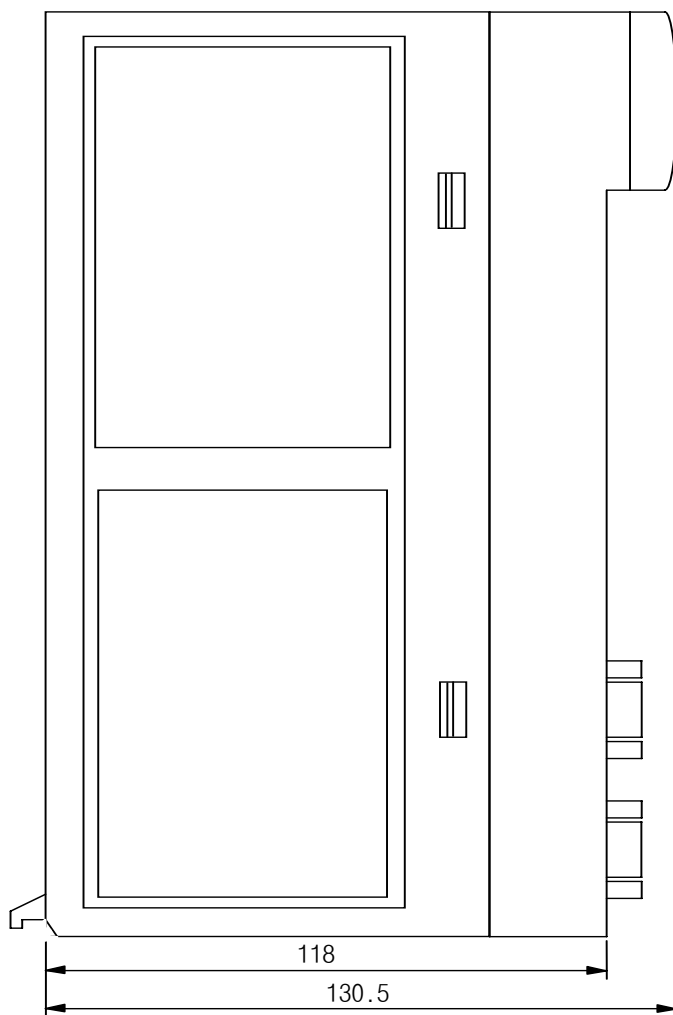
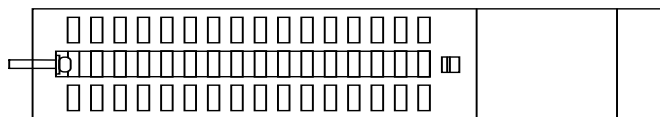

Unit : mm

2) Mnet units to be applied

G0L-MUEA

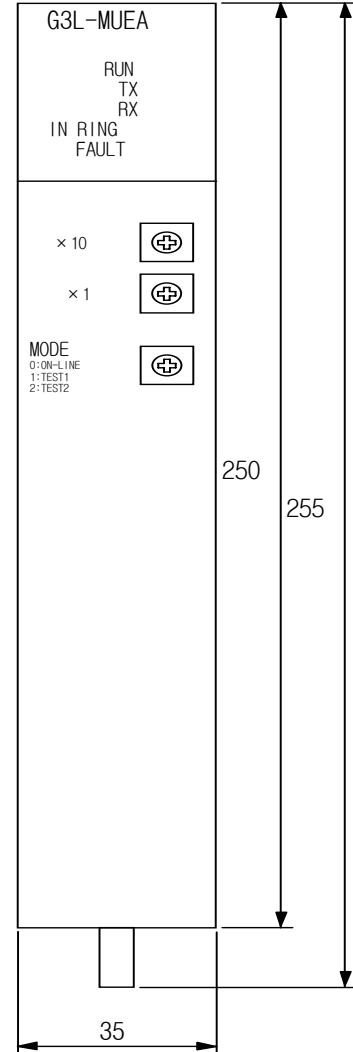
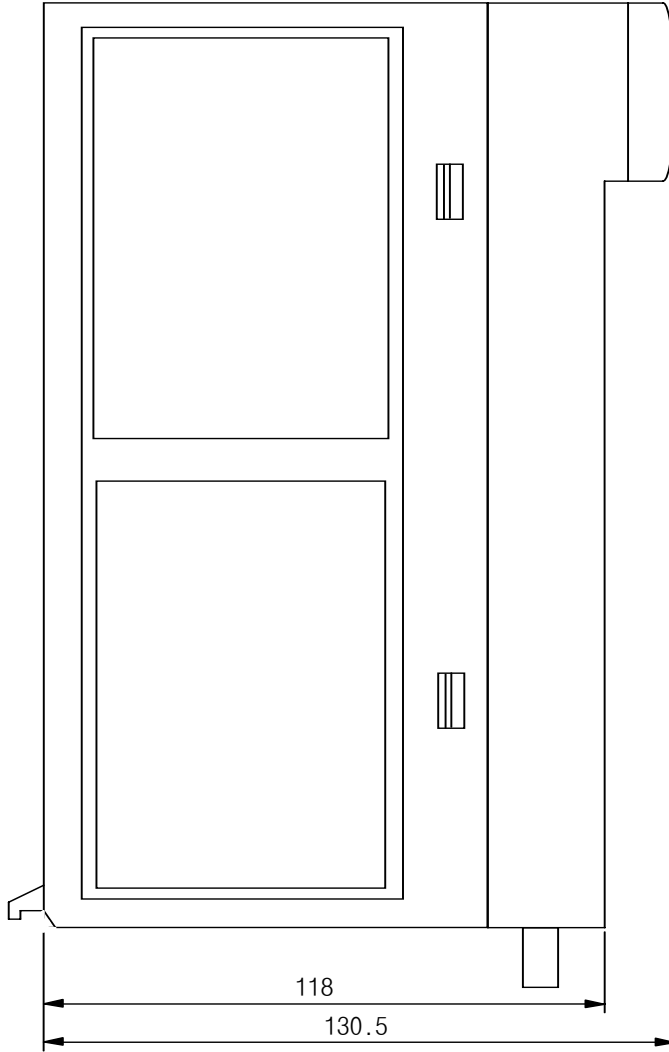
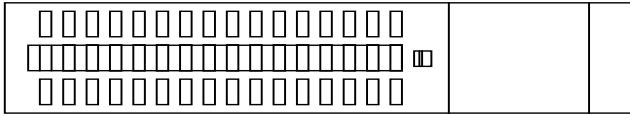

Unit : mm

A4.2 For mounting GM4

1) Fnet

G4L_FUEA, G4L-RBEA

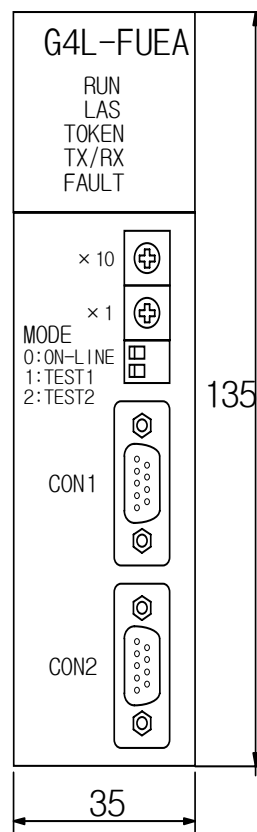
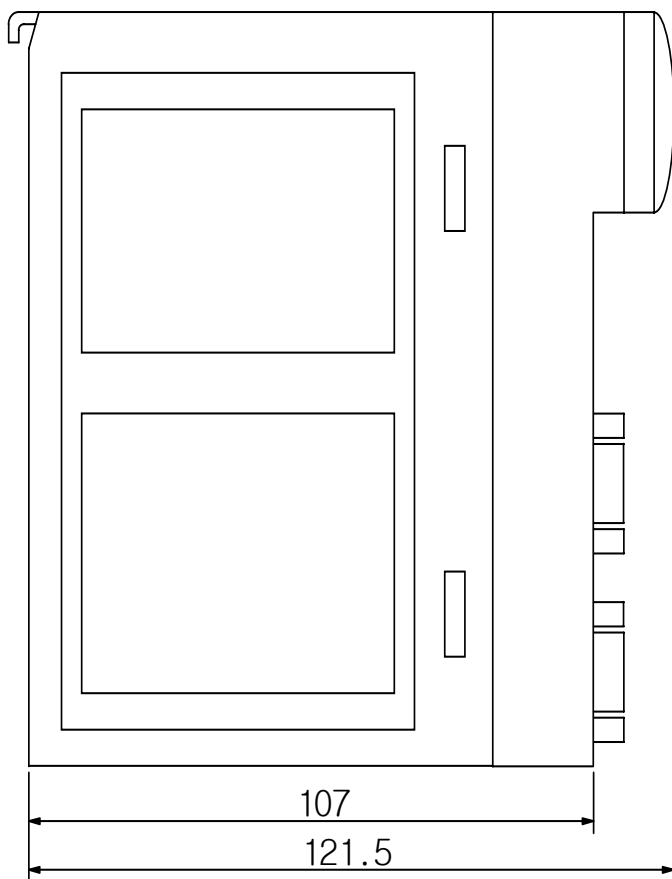
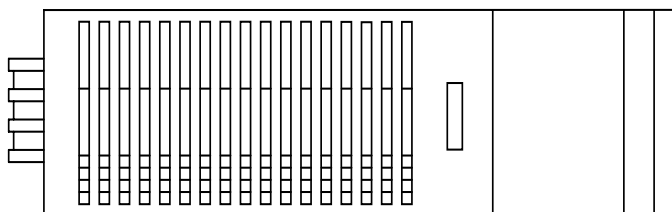

Unit : mm

A4.3 For mounting GM6

1) Fnet

G6L-FUEA

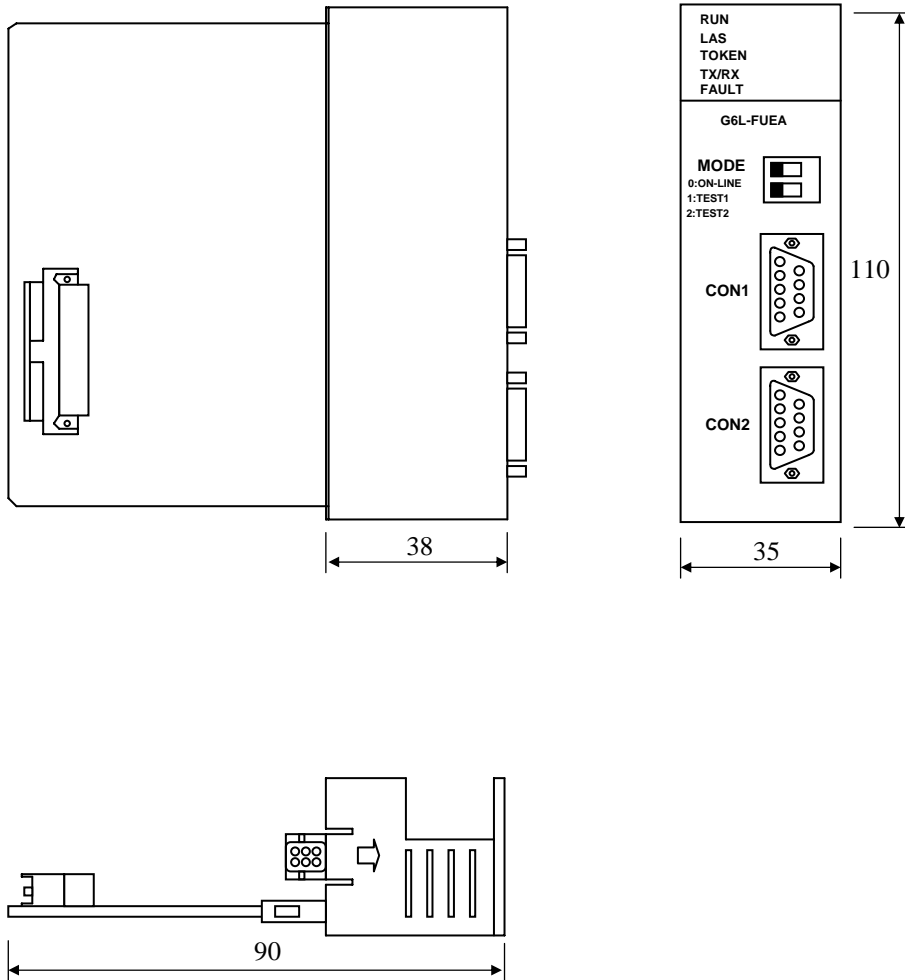

A4.4 For mounting on PC(computer)

1) GOL-FUEA

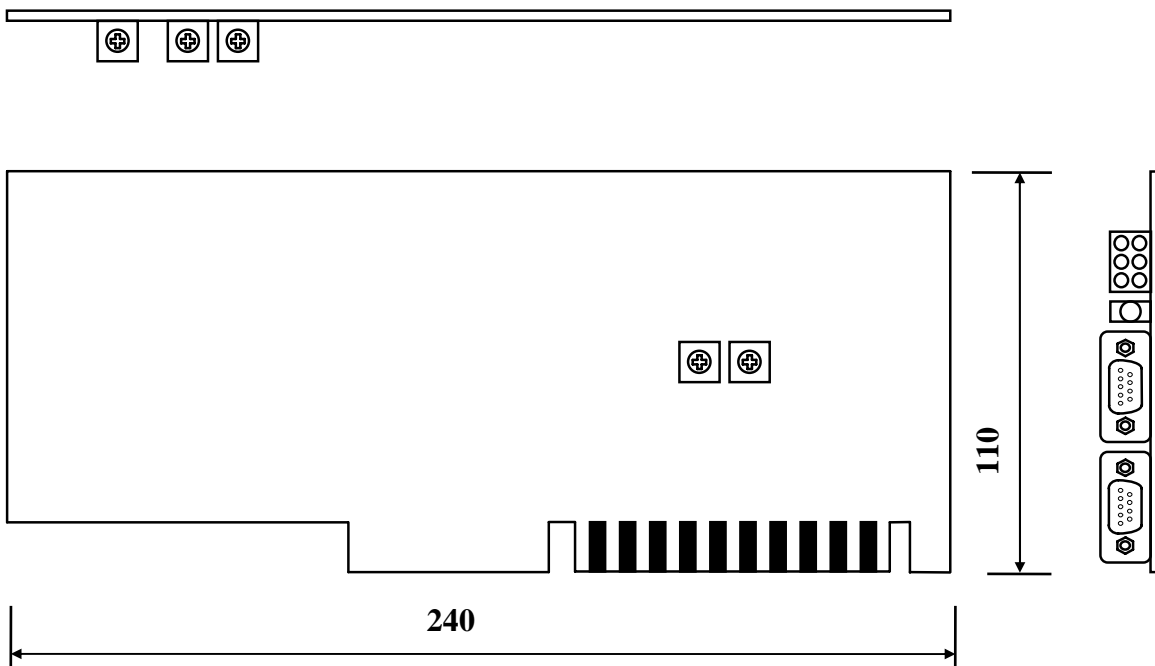

2) GOL-MUEA

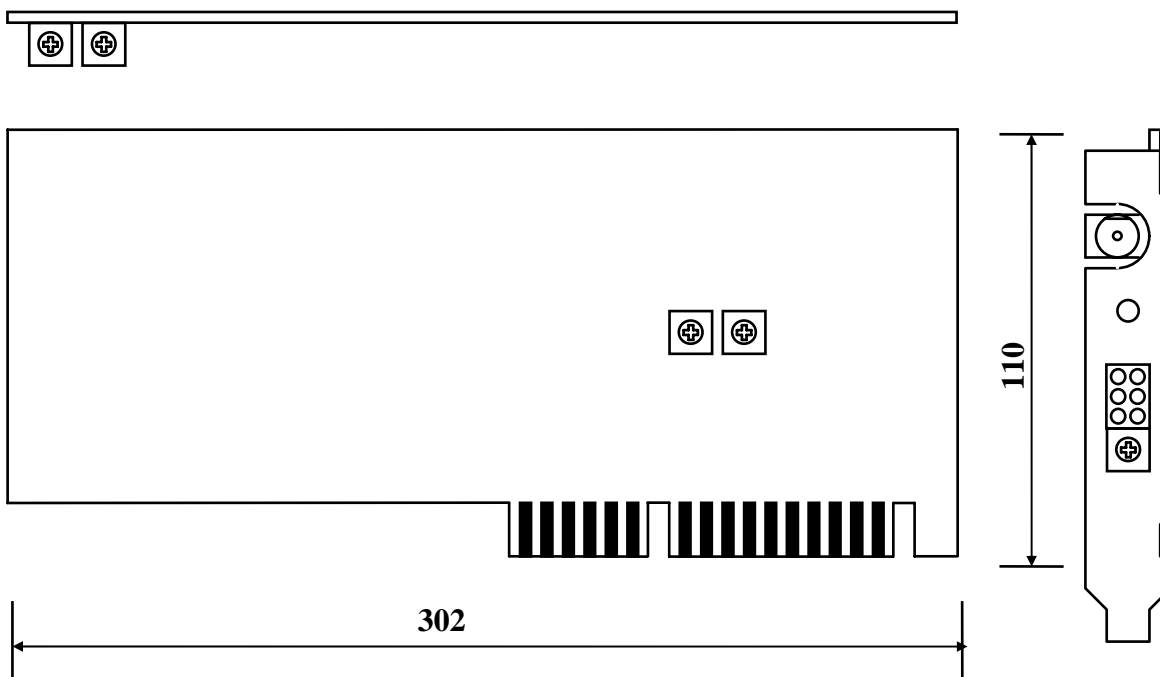

Unit : mm

A4.5 Fnet option module

1) Units to be applied

- Stand-alone remote (G0L-SMQA/G0L-SMIA/G0L-SMHA)
- Repeater(G0L-FREA)
- Optical, electric signal switching module(G0L-FOEA)

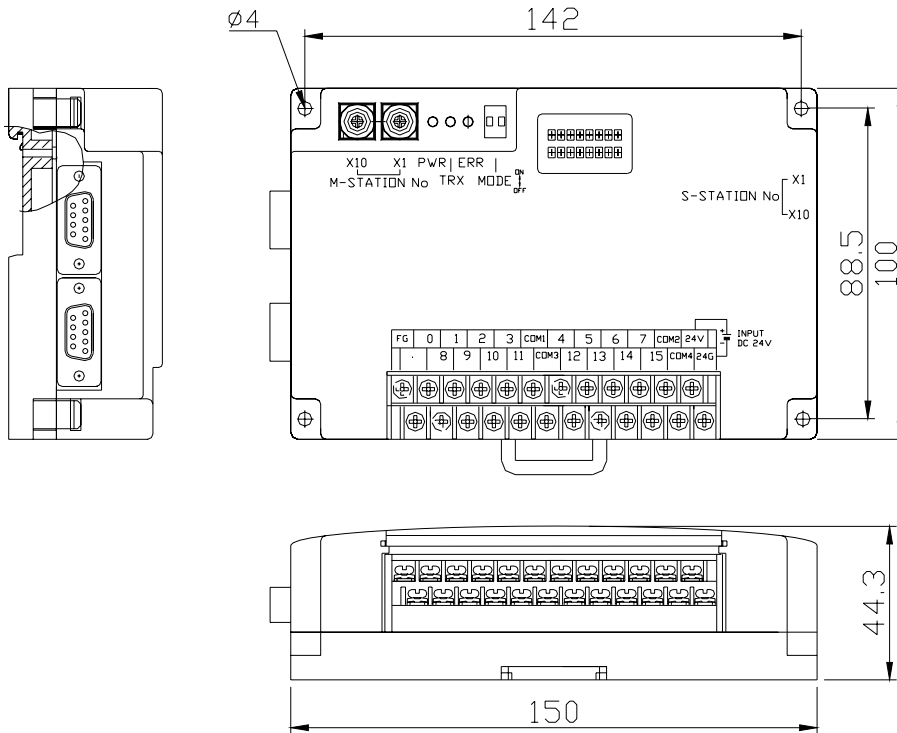

- Active coupler(with G0L-FAPA/G0L-FABA/G0L-FACA assembled)

